

PowerFlex 520-Series Adjustable Frequency AC Drive

PowerFlex 523 Catalog Number 25A

PowerFlex 525 Catalog Number 25B

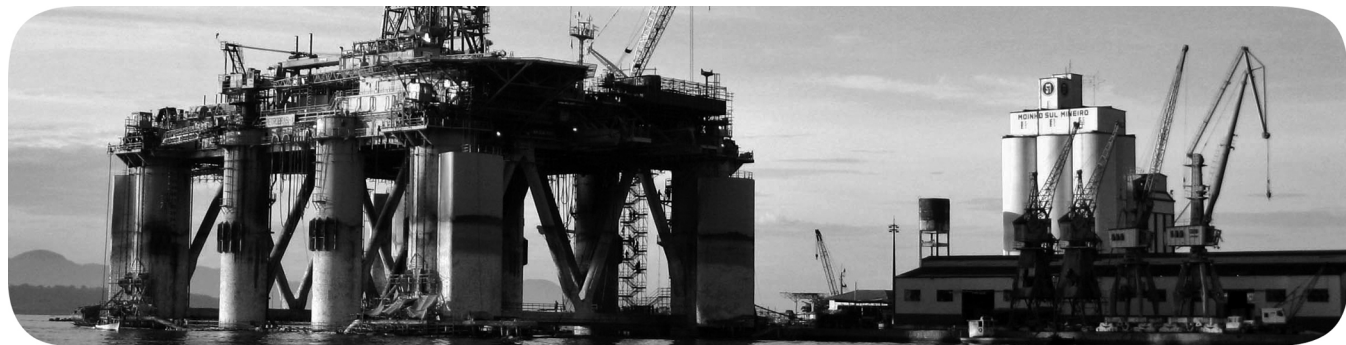

Original Instructions

Important User Information

Solid-state equipment has operational characteristics differing from those of electromechanical equipment. Safety Guidelines for the Application, Installation and Maintenance of Solid State Controls (publication [SGI-1.1](#) available from your local Rockwell Automation® sales office or online at <http://www.rockwellautomation.com/literature/>) describes some important differences between solid-state equipment and hard-wired electromechanical devices. Because of this difference, and also because of the wide variety of uses for solid-state equipment, all persons responsible for applying this equipment must satisfy themselves that each intended application of this equipment is acceptable.

In no event will Rockwell Automation, Inc. be responsible or liable for indirect or consequential damages resulting from the use or application of this equipment.

The examples and diagrams in this manual are included solely for illustrative purposes. Because of the many variables and requirements associated with any particular installation, Rockwell Automation, Inc. cannot assume responsibility or liability for actual use based on the examples and diagrams.

No patent liability is assumed by Rockwell Automation, Inc. with respect to use of information, circuits, equipment, or software described in this manual.

Reproduction of the contents of this manual, in whole or in part, without written permission of Rockwell Automation, Inc., is prohibited.

Throughout this manual, when necessary, we use notes to make you aware of safety considerations.



WARNING: Identifies information about practices or circumstances that can cause an explosion in a hazardous environment, which may lead to personal injury or death, property damage, or economic loss.



ATTENTION: Identifies information about practices or circumstances that can lead to personal injury or death, property damage, or economic loss. Attentions help you identify a hazard, avoid a hazard, and recognize the consequence.



SHOCK HAZARD: Labels may be on or inside the equipment, for example, a drive or motor, to alert people that dangerous voltage may be present.



BURN HAZARD: Labels may be on or inside the equipment, for example, a drive or motor, to alert people that surfaces may reach dangerous temperatures.



ARC FLASH HAZARD: Labels may be on or inside the equipment, for example, a motor control center, to alert people to potential Arc Flash. Arc Flash will cause severe injury or death. Wear proper Personal Protective Equipment (PPE). Follow ALL Regulatory requirements for safe work practices and for Personal Protective Equipment (PPE).

IMPORTANT

Identifies information that is critical for successful application and understanding of the product.

This manual contains new and updated information.

New and Updated Information

This table contains the changes made to this revision.

Topic	Page
Added Warning table for Motor Cable Length Restrictions	32
Updated Maximum Control Wire Recommendations information on noise immunity	36
Updated Start Method and Stop Method tables for PowerFlex 523 drives	37
Updated Start Method and Stop Method tables for PowerFlex 525 drives	40
Added Important table for EMC category C3 installation information	52
Updated Additional Installation Requirements table for meeting EMC	53
Updated Recommended Placement of EMC Cores table	54
Added software version requirement for Automatic Device Configuration (ADC) support	60
Added new parameter d392 [RdyBit Mode Act]	67 , 106 , 142
Added new parameter A574 [RdyBit Mode Cfg]	67 , 129 , 142
Updated descriptions of options for parameter P040 [Autotune]	78
Updated description of PointStop for option 10 and 11 of parameter P045 [Stop Mode]	79
Added Important table to parameter P046, P048, P050 [Start Source x]	80
Updated entries for Maximum Output column of parameter t088 [Analog Out Sel] from "200% Drive Rated FLA" to "200% Drive Rated Current"	89
Added table of recommended minimum Encoder PPR to parameter A536 [Encoder PPR]	122
Updated Intermittent Overload specification for PowerFlex 523	158
Added catalog numbers for replacement EMC cores	170
Updated I/O Terminals C1 and C2 wiring information on noise immunity	190
Added recommended Ethernet cables to description of Appendix H	235
General maintenance updates	Throughout manual

Notes:

	Preface	
Overview	Who Should Use this Manual	9
	Recommended Documentation	9
	Manual Conventions	10
	Drive Frame Sizes	11
	General Precautions	12
	Catalog Number Explanation	13
	Chapter 1	
Installation/Wiring	Mounting Considerations.....	15
	AC Supply Source Considerations.....	19
	General Grounding Requirements	20
	Fuses and Circuit Breakers	22
	Power and Control Module	27
	Control Module Cover	30
	Power Module Terminal Guard	30
	Power Wiring.....	31
	Power Terminal Block.....	34
	Common Bus/Precharge Notes	35
	I/O Wiring	35
	Control I/O Terminal Block.....	36
	Start and Speed Reference Control	46
	CE Conformity	49
	Chapter 2	
Start Up	Prepare for Drive Start-Up.....	55
	Display and Control Keys.....	58
	Viewing and Editing Parameters.....	59
	Drive Programming Tools	60
	Language Support	60
	Smart Start-Up with Basic Program Group Parameters.....	61
	LCD Display with QuickView	63
	Using the USB Port	63
	Chapter 3	
Programming and Parameters	About Parameters	65
	Parameter Groups	66
	Basic Display Group.....	71
	Basic Program Group.....	76
	Terminal Block Group.....	82
	Communications Group.....	94
	Logic Group	100
	Advanced Display Group	103
Advanced Program Group	107	
Network Parameter Group.....	130	

	Modified Parameter Group	130
	Fault and Diagnostic Group.....	130
	AppView Parameter Groups	138
	CustomView Parameter Group.....	139
	Parameter Cross Reference by Name.....	140
	Chapter 4	
Troubleshooting	Drive Status	145
	Faults	145
	Fault Descriptions.....	147
	Common Symptoms and Corrective Actions	150
	Appendix A	
Supplemental Drive Information	Certifications	155
	Environmental Specifications	156
	Technical Specifications	157
	Power Specifications.....	160
	Appendix B	
Accessories and Dimensions	Product Selection	163
	Product Dimensions.....	173
	Optional Accessories and Kits.....	186
	Appendix C	
RS485 (DSI) Protocol	Network Wiring	189
	Parameter Configuration	190
	Supported Modbus Function Codes	191
	Writing (06) Logic Command Data	191
	Writing (06) Comm Frequency Command.....	193
	Reading (03) Logic Status Data.....	193
	Reading (03) Drive Error Codes.....	195
	Reading (03) Drive Operational Values	196
	Reading (03) and Writing (06) Drive Parameters	196
	Additional Information.....	196
	Appendix D	
Velocity StepLogic, Basic Logic and Timer/Counter Functions	Velocity StepLogic Using Timed Steps.....	198
	Velocity StepLogic Using Basic Logic Functions	198
	Timer Function.....	199
	Counter Function.....	200
	Velocity StepLogic Parameters	201

Encoder/Pulse Train Usage and Position StepLogic Application	Appendix E		
		Encoder and Pulse Train Usage.....	203
		Wiring Notes	204
		Positioning Overview.....	205
		Common Guidelines for All Applications	205
		Positioning Operation	206
		Homing Routine	210
		Encoder and Position Feedback	211
		Use Over Communications	212
		Setup Notes.....	213
PID Set Up	Appendix F		
		PID Loop.....	215
		PID Reference and Feedback	217
Safe-Torque-Off Function	Appendix G		
		PowerFlex 525 Safe-Torque-Off Overview	223
		EC Type Examination Certification	224
		EMC Instructions.....	224
		Using PowerFlex 525 Safe-Torque-Off.....	224
		Safety Concept.....	225
		Enabling PowerFlex 525 Safe-Torque-Off.....	227
		Wiring	227
		PowerFlex 525 Safe-Torque-Off Operation	227
		Verify Operation	228
EtherNet/IP		Connection Examples	229
		PowerFlex 525 Certification for Safe-Torque-Off.....	233
Control Diagrams	Appendix H		
		Establishing A Connection With EtherNet/IP	235
	Appendix I		
		Induction Motor Tuning Diagrams.....	237
		Adjusting Speed Control Parameters.....	238

Notes:

Overview

The purpose of this manual is to provide you with the basic information needed to install, start-up and troubleshoot the PowerFlex® 520-Series Adjustable Frequency AC Drive.

For information on...	See page...
Who Should Use this Manual	9
Recommended Documentation	9
Manual Conventions	10
Drive Frame Sizes	11
General Precautions	12
Catalog Number Explanation	13

Who Should Use this Manual

This manual is intended for qualified personnel. You must be able to program and operate Adjustable Frequency AC Drive devices. In addition, you must have an understanding of the parameter settings and functions.

Recommended Documentation

All the recommended documentation listed in this section is available online at <http://www.rockwellautomation.com/literature/>.

The following publications provide general drive information:

Title	Publication
Wiring and Grounding Guidelines for Pulse Width Modulated (PWM) AC Drives	DRIVES-IN001
Preventive Maintenance of Industrial Control and Drive System Equipment	DRIVES-TD001
Safety Guidelines for the Application, Installation and Maintenance of Solid State Control	SGI-1.1
A Global Reference Guide for Reading Schematic Diagrams	100-2.10
Guarding Against Electrostatic Damage	8000-4.5.2

The following publications provide specific PowerFlex 520-Series information on drive installation, features, specifications, and service:

Title	Publication
PowerFlex 520-Series AC Drive Specifications	520-TD001
PowerFlex Dynamic Braking Resistor Calculator	PFLEX-AT001
PowerFlex AC Drives in Common Bus Configurations	DRIVES-AT002

The following publications provide specific Network Communications information:

Title	Publication
PowerFlex 525 Embedded EtherNet/IP Adapter	520COM-UM001
PowerFlex 25-COMM-D DeviceNet Adapter	520COM-UM002
PowerFlex 25-COMM-E2P Dual-Port EtherNet/IP Adapter	520COM-UM003
PowerFlex 25-COMM-P PROFIBUS DPV1 Adapter	520COM-UM004

Manual Conventions

- In this manual we refer to PowerFlex 520-Series Adjustable Frequency AC Drive as; drive, PowerFlex 520-series, PowerFlex 520-series drive or PowerFlex 520-series AC drive.
- Specific drives within the PowerFlex 520-series may be referred to as:
 - PowerFlex 523, PowerFlex 523 drive or PowerFlex 523 AC drive.
 - PowerFlex 525, PowerFlex 525 drive or PowerFlex 525 AC drive.
- Parameter numbers and names are shown in this format:

P 031 [Motor NP Volts]

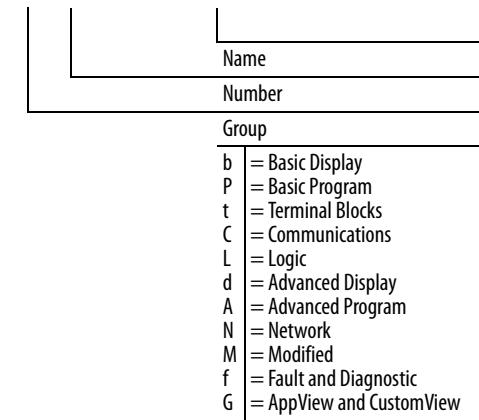

- The following words are used throughout the manual to describe an action:

Words	Meaning
Can	Possible, able to do something
Cannot	Not possible, not able to do something
May	Permitted, allowed
Must	Unavoidable, you must do this
Shall	Required and necessary
Should	Recommended
Should Not	Not Recommended

- The Studio 5000® Engineering and Design Environment combines engineering and design elements into a common environment. The first element in the Studio 5000 environment is the Logix Designer application. The Studio 5000 Logix Designer™ application is the rebranding of RSLogix™ 5000 software and will continue to be the product to program Logix 5000 controllers for discrete, process, batch, motion, safety, and drive-based solutions. The Studio 5000 environment is the foundation for the future of Rockwell Automation engineering design tools and capabilities. It is the one place for design engineers to develop all the elements of their control system.

Drive Frame Sizes

Similar PowerFlex 520-series drive sizes are grouped into frame sizes to simplify spare parts ordering, dimensioning, etc. A cross reference of drive catalog numbers and their respective frame sizes is provided in [Appendix B](#).

General Precautions



ATTENTION: The drive contains high voltage capacitors which take time to discharge after removal of mains supply. Before working on drive, ensure isolation of mains supply from line inputs [R, S, T (L1, L2, L3)]. Wait three minutes for capacitors to discharge to safe voltage levels. Failure to do so may result in personal injury or death.

Darkened display LEDs is not an indication that capacitors have discharged to safe voltage levels.

ATTENTION: Only qualified personnel familiar with adjustable frequency AC drives and associated machinery should plan or implement the installation, start-up and subsequent maintenance of the system. Failure to comply may result in personal injury and/or equipment damage.

ATTENTION: This drive contains ESD (Electrostatic Discharge) sensitive parts and assemblies. Static control precautions are required when installing, testing, servicing or repairing this assembly. Component damage may result if ESD control procedures are not followed. If you are not familiar with static control procedures, reference A-B publication 8000-4.5.2, "Guarding Against Electrostatic Damage" or any other applicable ESD protection handbook.

ATTENTION: An incorrectly applied or installed drive can result in component damage or a reduction in product life. Wiring or application errors, such as undersizing the motor, incorrect or inadequate AC supply, or excessive ambient temperatures may result in malfunction of the system.

ATTENTION: The bus regulator function is extremely useful for preventing nuisance overvoltage faults resulting from aggressive decelerations, overhauling loads, and eccentric loads. However, it can also cause either of the following two conditions to occur.

1. Fast positive changes in input voltage or imbalanced input voltages can cause uncommanded positive speed changes;
2. Actual deceleration times can be longer than commanded deceleration times. However, a "Stall Fault" is generated if the drive remains in this state for 1 minute. If this condition is unacceptable, the bus regulator must be disabled (see parameter A550 [Bus Reg Enable]). In addition, installing a properly sized dynamic brake resistor will provide equal or better performance in most cases.

ATTENTION: Risk of injury or equipment damage exists. Drive does not contain user-serviceable components. Do not disassemble drive chassis.

Catalog Number Explanation

1-3	4	5	6-8	9	10	11	12	13	14
25B	–	B	2P3	N	1	1	4	–	–
Drive	Dash	Voltage Rating	Rating	Enclosure	Reserved	Emission Class	Reserved	Dash	Dash

Code	Type
25A	PowerFlex 523
25B	PowerFlex 525

Code	EMC Filter
0	No Filter
1	Filter

Code	Braking
4	Standard

Code	Voltage	Phase
V	120V AC	1
A	240V AC	1
B	240V AC	3
D	480V AC	3
E	600V AC	3

Code	Interface Module
1	Standard

Code	Enclosure
N	IP20 NEMA / Open

Output Current @ 1 Phase, 100...120V Input						
Code	Amps	Frame	ND		HD	
			HP	kW	HP	kW
1P6 ⁽¹⁾	1.6	A	0.25	0.2	0.25	0.2
2P5	2.5	A	0.5	0.4	0.5	0.4
4P8	4.8	B	1.0	0.75	1.0	0.75
6P0	6.0	B	1.5	1.1	1.5	1.1

Output Current @ 3 Phase, 380...480V Input						
Code	Amps	Frame	ND		HD	
			HP	kW	HP	kW
1P4	1.4	A	0.5	0.4	0.5	0.4
2P3	2.3	A	1.0	0.75	1.0	0.75
4P0	4.0	A	2.0	1.5	2.0	1.5
6P0	6.0	A	3.0	2.2	3.0	2.2
010	10.5	B	5.0	4.0	5.0	4.0
013	13.0	C	7.5	5.5	7.5	5.5
017	17.0	C	10.0	7.5	10.0	7.5
024	24.0	D	15.0	11.0	15.0	11.0
030 ⁽²⁾	30.0	D	20.0	15.0	15.0	11.0
037 ⁽²⁾	37.0	E	25.0	18.5	20.0	15.0
043 ⁽²⁾	43.0	E	30.0	22.0	25.0	18.5

Output Current @ 1 Phase, 200...240V Input						
Code	Amps	Frame	ND		HD	
			HP	kW	HP	kW
1P6 ⁽¹⁾	1.6	A	0.25	0.2	0.25	0.2
2P5	2.5	A	0.5	0.4	0.5	0.4
4P8	4.8	A	1.0	0.75	1.0	0.75
8P0	8.0	B	2.0	1.5	2.0	1.5
011	11.0	B	3.0	2.2	3.0	2.2

Output Current @ 3 Phase, 525...600V Input						
Code	Amps	Frame	ND		HD	
			HP	kW	HP	kW
0P9	0.9	A	0.5	0.4	0.5	0.4
1P7	1.7	A	1.0	0.75	1.0	0.75
3P0	3.0	A	2.0	1.5	2.0	1.5
4P2	4.2	A	3.0	2.2	3.0	2.2
6P6	6.6	B	5.0	4.0	5.0	4.0
9P9	9.9	C	7.5	5.5	7.5	5.5
012	12.0	C	10.0	7.5	10.0	7.5
019	19.0	D	15.0	11.0	15.0	11.0
022 ⁽²⁾	22.0	D	20.0	15.0	15.0	11.0
027 ⁽²⁾	27.0	E	25.0	18.5	20.0	15.0
032 ⁽²⁾	32.0	E	30.0	22.0	25.0	18.5

Output Current @ 3Phase, 200...240V Input						
Code	Amps	Frame	ND		HD	
			HP	kW	HP	kW
1P6 ⁽¹⁾	1.6	A	0.25	0.2	0.25	0.2
2P5	2.5	A	0.5	0.4	0.5	0.4
5P0	5.0	A	1.0	0.75	1.0	0.75
8P0	8.0	A	2.0	1.5	2.0	1.5
011	11.0	A	3.0	2.2	3.0	2.2
017	17.5	B	5.0	4.0	5.0	4.0
024	24.0	C	7.5	5.5	7.5	5.5
032	32.2	D	10.0	7.5	10.0	7.5
048 ⁽²⁾	48.3	E	15.0	11.0	10.0	7.5
062 ⁽²⁾	62.1	E	20.0	15.0	15.0	11.0

(1) This rating is only available for PowerFlex 523 drives.
 (2) Normal and Heavy Duty ratings are available for this drive.

Notes:

Installation/Wiring

This chapter provides information on mounting and wiring the PowerFlex 520-series drives.

For information on...	See page...
Mounting Considerations	15
AC Supply Source Considerations	19
General Grounding Requirements	20
Fuses and Circuit Breakers	22
Power and Control Module	27
Control Module Cover	30
Power Module Terminal Guard	30
Power Wiring	31
Power Terminal Block	34
Common Bus/Precharge Notes	35
I/O Wiring	35
Control I/O Terminal Block	36
Start and Speed Reference Control	46
CE Conformity	49

Most start-up difficulties are the result of incorrect wiring. Every precaution must be taken to assure that the wiring is done as instructed. All items must be read and understood before the actual installation begins.



ATTENTION: The following information is merely a guide for proper installation. Rockwell Automation cannot assume responsibility for the compliance or the noncompliance to any code, national, local or otherwise for the proper installation of this drive or associated equipment. A hazard of personal injury and/or equipment damage exists if codes are ignored during installation.

Mounting Considerations

- Mount the drive upright on a flat, vertical and level surface.

Frame	Screw Size	Screw Torque
A	M5 (#10...24)	1.56...1.96 Nm (14...17 lb-in.)
B	M5 (#10...24)	1.56...1.96 Nm (14...17 lb-in.)
C	M5 (#10...24)	1.56...1.96 Nm (14...17 lb-in.)
D	M5 (#10...24)	2.45...2.94 Nm (22...26 lb-in.)
E	M8 (5/16 in.)	6.0...7.4 Nm (53...65 lb-in.)

- Protect the cooling fan by avoiding dust or metallic particles.

- Do not expose to a corrosive atmosphere.
- Protect from moisture and direct sunlight.

Minimum Mounting Clearances

See [Appendix B](#) for mounting dimensions.

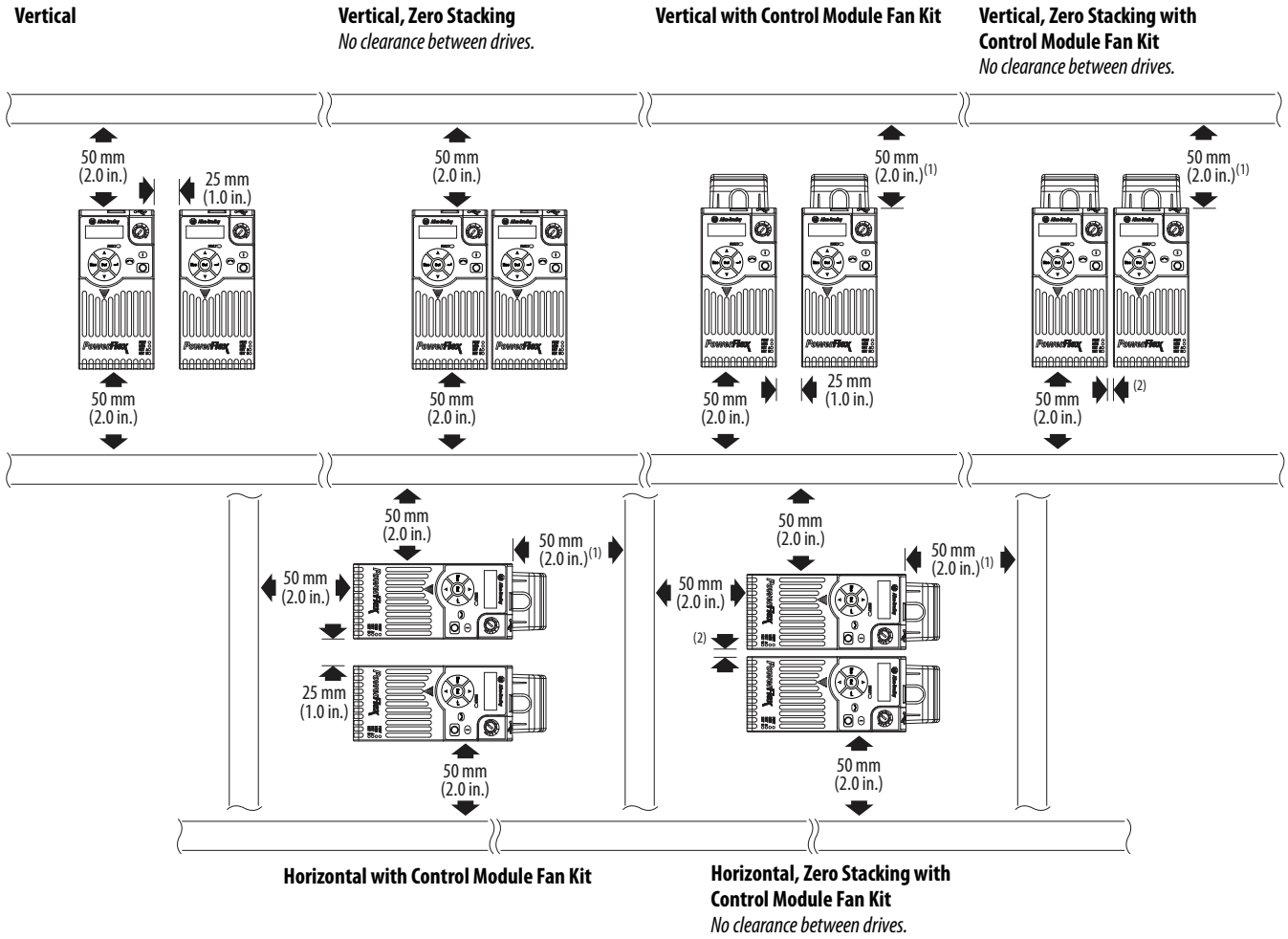

(1) For Frame E with Control Module Fan Kit only, clearance of 95 mm (3.7 in.) is required.
 (2) For Frame E with Control Module Fan Kit only, clearance of 12 mm (0.5 in.) is required.

Ambient Operating Temperatures

See [Appendix B](#) for option kits.

Mounting	Enclosure Rating ⁽¹⁾	Ambient Temperature			
		Minimum	Maximum (No Derate)	Maximum (Derate) ⁽²⁾	Maximum with Control Module Fan Kit (Derate) ⁽³⁾⁽⁵⁾
Vertical	IP 20/Open Type	-20 °C (-4 °F)	50 °C (122 °F)	60 °C (140 °F)	70 °C (158 °F)
	IP 30/NEMA 1/UL Type 1		45 °C (113 °F)	55 °C (131 °F)	—
Vertical, Zero Stacking	IP 20/Open Type		45 °C (113 °F)	55 °C (131 °F)	65 °C (149 °F)
	IP 30/NEMA 1/UL Type 1		40 °C (104 °F)	50 °C (122 °F)	—
Horizontal with Control Module Fan Kit ⁽⁴⁾⁽⁵⁾	IP 20/Open Type		50 °C (122 °F)	—	70 °C (158 °F)
Horizontal, Zero Stacking with Control Module Fan Kit ⁽⁴⁾⁽⁵⁾	IP 20/Open Type		45 °C (113 °F)	—	65 °C (149 °F)

- (1) IP 30/NEMA 1/UL Type 1 rating requires installation of the PowerFlex 520-Series IP 30/NEMA 1/UL Type 1 option kit, catalog number 25-JBAx.
- (2) For catalogs 25x-D1P4N104 and 25x-E0P9N104, the temperature listed under the Maximum (Derate) column is reduced by 5 °C (9 °F) for all mounting methods.
- (3) For catalogs 25x-D1P4N104 and 25x-E0P9N104, the temperature listed under the Maximum with Control Module Fan Kit (Derate) column is reduced by 10 °C (18 °F) for vertical and vertical with zero stacking mounting methods only.
- (4) Catalogs 25x-D1P4N104 and 25x-E0P9N104 cannot be mounted using either of the horizontal mounting methods.
- (5) Requires installation of the PowerFlex 520-Series Control Module Fan Kit, catalog number 25-FANx-70C.

Current Derating Curves

Vertical Mounting

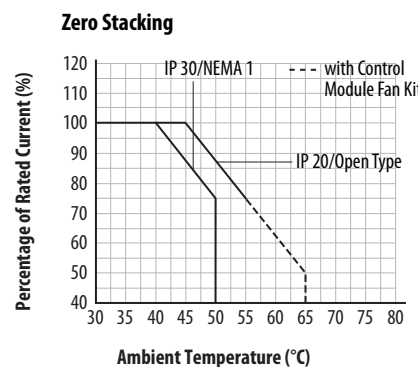
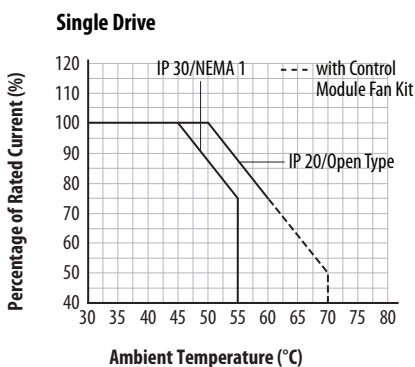

Horizontal/Floor Mounting

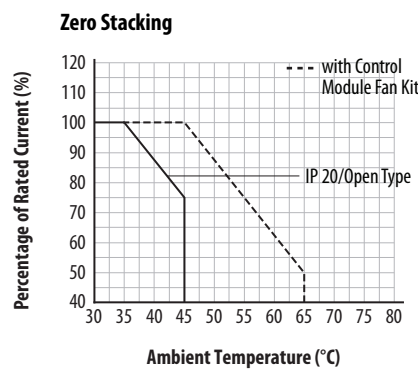
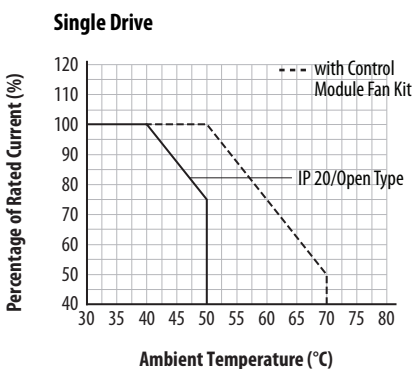

Derating Guidelines for High Altitude

The drive can be used without derating at a maximum altitude of 1000 m (3300 ft). If the drive is used above 1000 m (3300 ft):

- Derate the maximum ambient temperature by 5 °C (9 °F) for every additional 1000 m (3300 ft), subject to limits listed in the [Altitude Limit \(Based on Voltage\)](#) table below.
- Or
- Derate the output current by 10% for every additional 1000 m (3300 ft), up to 3000 m (9900 ft), subject to limits listed in the [Altitude Limit \(Based on Voltage\)](#) table below.

Altitude Limit (Based on Voltage)

Drive Rating	Center Ground (Wye Neutral)	Corner Ground, Impedance Ground, or Ungrounded
100...120V 1-Phase	6000 m	6000 m
200...240V 1-Phase	2000 m	2000 m
200...240V 3-Phase	6000 m	2000 m
380...480V 3-Phase	4000 m	2000 m
525...600V 3-Phase	2000 m	2000 m

High Altitude

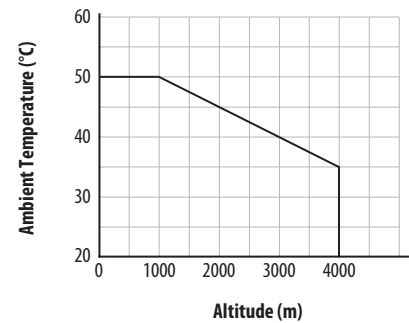
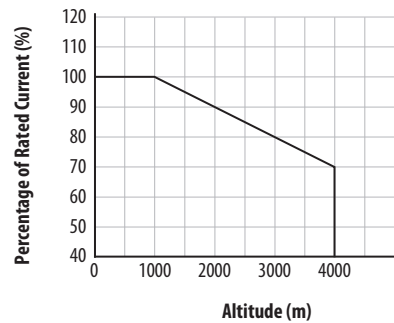

Debris Protection

Take precautions to prevent debris from falling through the vents of the drive housing during installation.

Storage

- Store within an ambient temperature range of -40...85°C⁽¹⁾.
- Store within a relative humidity range of 0...95%, noncondensing.
- Do not expose to a corrosive atmosphere.

(1) The maximum ambient temperature for storing a Frame E drive is 70 °C.

AC Supply Source Considerations

Ungrounded Distribution Systems



ATTENTION: PowerFlex 520-series drives contain protective MOVs that are referenced to ground. These devices must be disconnected if the drive is installed on an ungrounded or resistive grounded distribution system.

ATTENTION: Removing MOVs in drives with an embedded filter will also disconnect the filter capacitor from earth ground.

Disconnecting MOVs

To prevent drive damage, the MOVs connected to ground shall be disconnected if the drive is installed on an ungrounded distribution system (IT mains) where the line-to-ground voltages on any phase could exceed 125% of the nominal line-to-line voltage. To disconnect these devices, remove the jumper shown in the diagrams below.

1. Turn the screw counterclockwise to loosen.
2. Pull the jumper completely out of the drive chassis.
3. Tighten the screw to keep it in place.

Jumper Location (Typical)

Power Module

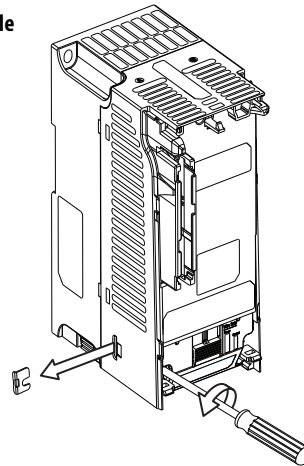

IMPORTANT Tighten screw after jumper removal.

Phase to Ground MOV Removal

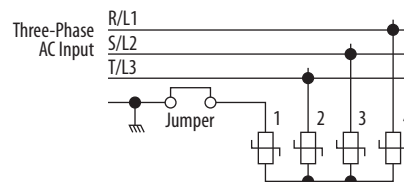

Input Power Conditioning

The drive is suitable for direct connection to input power within the rated voltage of the drive (see [page 157](#)). Listed in the [Input Power Conditions](#) table below are certain input power conditions which may cause component damage or reduction in product life. If any of these conditions exist, install one of the devices listed under the heading Corrective Action on the line side of the drive.

IMPORTANT Only one device per branch circuit is required. It should be mounted closest to the branch and sized to handle the total current of the branch circuit.

Input Power Conditions

Input Power Condition	Corrective Action
Low Line Impedance (less than 1% line reactance)	<ul style="list-style-type: none"> • Install Line Reactor⁽²⁾ • or Isolation Transformer
Greater than 120 kVA supply transformer	
Line has power factor correction capacitors	<ul style="list-style-type: none"> • Install Line Reactor⁽²⁾ • or Isolation Transformer
Line has frequent power interruptions	
Line has intermittent noise spikes in excess of 6000V (lightning)	
Phase to ground voltage exceeds 125% of normal line to line voltage	<ul style="list-style-type: none"> • Remove MOV jumper to ground. • or Install Isolation Transformer with grounded secondary if necessary.
Ungrounded distribution system	
240V open delta configuration (stinger leg) ⁽¹⁾	<ul style="list-style-type: none"> • Install Line Reactor⁽²⁾

(1) For drives applied on an open delta with a middle phase grounded neutral system, the phase opposite the phase that is tapped in the middle to the neutral or earth is referred to as the “stinger leg,” “high leg,” “red leg,” etc. This leg should be identified throughout the system with red or orange tape on the wire at each connection point. The stinger leg should be connected to the center Phase B on the reactor. See [Bulletin 1321-3R Series Line Reactors on page 171](#) for specific line reactor part numbers.

(2) See [Appendix B](#) for accessory ordering information.

General Grounding Requirements

The drive Safety Ground - \ominus (PE) must be connected to system ground. Ground impedance must conform to the requirements of national and local industrial safety regulations and/or electrical codes. The integrity of all ground connections should be periodically checked.

Typical Grounding

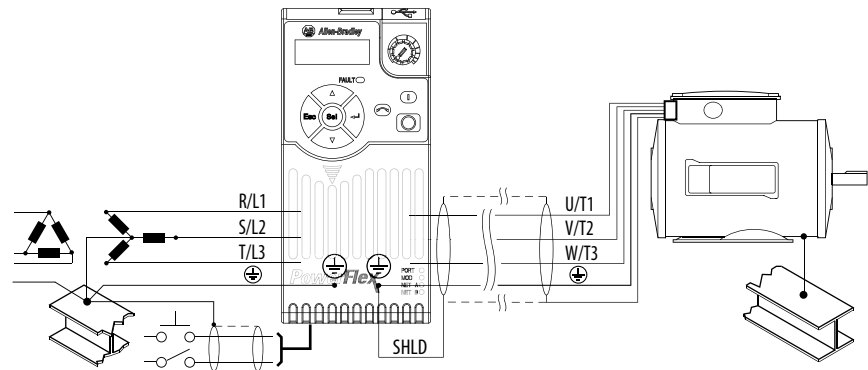

Ground Fault Monitoring

If a system ground fault monitor (RCD) is to be used, only Type B (adjustable) devices should be used to avoid nuisance tripping.

Safety Ground - (PE)

This is the safety ground for the drive that is required by code. One of these points must be connected to adjacent building steel (girder, joist), a floor ground rod or bus bar. Grounding points must comply with national and local industrial safety regulations and/or electrical codes.

Motor Ground

The motor ground must be connected to one of the ground terminals on the drive.

Shield Termination - SHLD

Either of the safety ground terminals located on the power terminal block provides a grounding point for the motor cable shield. The **motor cable** shield connected to one of these terminals (drive end) should also be connected to the motor frame (motor end). Use a shield terminating or EMI clamp to connect the shield to the safety ground terminal. The earthing plate or conduit box option may be used with a cable clamp for a grounding point for the cable shield.

When shielded cable is used for **control and signal wiring**, the shield should be grounded at the source end only, not at the drive end.

RFI Filter Grounding

Using a drive with filter may result in relatively high ground leakage currents. Therefore, the **filter must only be used in installations with grounded AC supply systems and be permanently installed and solidly grounded** (bonded) to the building power distribution ground. Ensure that the incoming supply neutral is solidly connected (bonded) to the same building power distribution ground. Grounding must not rely on flexible cables and should not include any form of plug or socket that would permit inadvertent disconnection. Some local codes may require redundant ground connections. The integrity of all connections should be periodically checked.

Fuses and Circuit Breakers

The PowerFlex 520-series drive does not provide branch short circuit protection. This product should be installed with either input fuses or an input circuit breaker. National and local industrial safety regulations and/or electrical codes may determine additional requirements for these installations.

The tables found on pages [23...26](#) provide recommended AC line input fuse and circuit breaker information. See Fusing and Circuit Breakers below for UL and IEC requirements. Sizes listed are the recommended sizes based on 40 °C (104 °F) and the U.S. N.E.C. Other country, state or local codes may require different ratings.

Fusing

The recommended fuse types are listed in the tables found on pages [23...26](#). If available current ratings do not match those listed in the tables provided, choose the next higher fuse rating.

- IEC – BS88 (British Standard) Parts 1 & 2⁽¹⁾, EN60269-1, Parts 1 & 2, type GG or equivalent should be used.
- UL – UL Class CC, T, RK1, or J should be used.

Circuit Breakers

The “non-fuse” listings in the tables found on pages [23...26](#) include inverse time circuit breakers, instantaneous trip circuit breakers (motor circuit protectors) and 140M self-protected combination motor controllers. If one of these is chosen as the desired protection method, the following requirements apply:

- IEC – Both types of circuit breakers and 140M self-protected combination motor controllers are acceptable for IEC installations.
- UL – Only inverse time circuit breakers and the specified 140M self-protected combination motor controllers are acceptable for UL installations.

Bulletin 140M (Self-Protected Combination Controller)/UL489 Circuit Breakers

When using Bulletin 140M or UL489 rated circuit breakers, the guidelines listed below must be followed in order to meet the NEC requirements for branch circuit protection.

- Bulletin 140M can be used in single motor applications.
- Bulletin 140M can be used up stream from the drive **without** the need for fuses.

(1) Typical designations include, but may not be limited to the following; Parts 1 & 2: AC, AD, BC, BD, CD, DD, ED, EFS, EF, FF, FG, GF, GG, GH.

Fuses and Circuit Breakers for PowerFlex 520-Series Drives

100...120V 1-Phase Input Protection Devices – Frames A...B

Catalog No.	Output Ratings						Input Ratings			Frame Size	Contactor No.	IEC Applications (Non-UL)			UL Applications		
	ND		HD		Amps	kVA	Max Amps ⁽¹⁾	Fuses (Rating)	Circuit Breakers			Fuses (Max. Rating)	Circuit Breakers	Fuses (Max. Rating)	Circuit Breakers	Min. Enclosure Vol. (in. ³)	
	HP	kW	HP	kW													Class / Catalog No.
PF 523																	
25A-V1P6N104	0.25	0.2	0.25	0.2	1.6	0.8	6.4	A	100-C09	10	16	140M-CZE-B63	140U-D6D2-B80	140U-D6D2-B80	140M-CZE-B63	140U-D6D2-B80	140M-CZE-B63
25A-V2P5N104	0.5	0.4	0.5	0.4	2.5	1.3	9.6	A	100-C12	16	20	140M-CZE-C10	140U-D6D2-C12	140U-D6D2-C12	140M-CZE-C10	140U-D6D2-C12	140M-CZE-C10
25A-V4P8N104	1.0	0.75	1.0	0.75	4.8	2.5	19.2	B	100-C23	25	40	140M-D8E-C20	140U-D6D2-C25	140U-D6D2-C25	140M-D8E-C20	140U-D6D2-C25	140M-D8E-C20
25A-V6P0N104	1.5	1.1	1.5	1.1	6.0	3.2	24.0	B	100-C37	32	50	140M-F8E-C25	140U-D6D2-C30	140U-D6D2-C30	140M-F8E-C25	140U-D6D2-C30	140M-F8E-C25

200...240V 1-Phase Input Protection Devices – Frames A...B

Catalog No.	Output Ratings						Input Ratings			Frame Size	Contactor No.	IEC Applications (Non-UL)			UL Applications		
	ND		HD		Amps	kVA	Max Amps ⁽¹⁾	Fuses (Rating)	Circuit Breakers			Fuses (Max. Rating)	Circuit Breakers	Fuses (Max. Rating)	Circuit Breakers	Min. Enclosure Vol. (in. ³)	
	HP	kW	HP	kW													Class / Catalog No.
PF 523																	
25A-A1P6N104	0.25	0.2	0.25	0.2	1.6	1.4	5.3	A	100-C09	6	10	140M-CZE-B63	140U-D6D2-C10	140U-D6D2-C10	140M-CZE-B63	140U-D6D2-C10	140M-CZE-B63
25A-A1P6N114	0.25	0.2	0.25	0.2	1.6	1.4	5.3	A	100-C09	6	10	140M-CZE-B63	140U-D6D2-C10	140U-D6D2-C10	140M-CZE-B63	140U-D6D2-C10	140M-CZE-B63
25A-A2P5N104	0.5	0.4	0.5	0.4	2.5	1.7	6.5	A	100-C09	10	16	140M-CZE-C10	140U-D6D2-C10	140U-D6D2-C10	140M-CZE-C10	140U-D6D2-C10	140M-CZE-C10
25A-A2P5N114	0.5	0.4	0.5	0.4	2.5	1.7	6.5	A	100-C09	10	16	140M-CZE-C10	140U-D6D2-C10	140U-D6D2-C10	140M-CZE-C10	140U-D6D2-C10	140M-CZE-C10
25A-A4P8N104	1.0	0.75	1.0	0.75	4.8	2.8	10.7	A	100-C12	16	25	140M-CZE-C16	140U-D6D2-C15	140U-D6D2-C15	140M-CZE-C16	140U-D6D2-C15	140M-CZE-C16
25A-A4P8N114	1.0	0.75	1.0	0.75	4.8	2.8	10.7	A	100-C12	16	25	140M-CZE-C16	140U-D6D2-C15	140U-D6D2-C15	140M-CZE-C16	140U-D6D2-C15	140M-CZE-C16
25A-A8P0N104	2.0	1.5	2.0	1.5	8.0	4.8	18.0	B	100-C23	25	40	140M-F8E-C25	140U-D6D2-C25	140U-D6D2-C25	140M-F8E-C25	140U-D6D2-C25	140M-F8E-C25
25A-A8P0N114	2.0	1.5	2.0	1.5	8.0	4.8	18.0	B	100-C23	25	40	140M-F8E-C25	140U-D6D2-C25	140U-D6D2-C25	140M-F8E-C25	140U-D6D2-C25	140M-F8E-C25
25A-A0T1N104	3.0	2.2	3.0	2.2	11.0	6.0	22.9	B	100-C37	32	50	140M-F8E-C25	140G-G6C3-C35	140G-G6C3-C35	140M-F8E-C25	140M-F8E-C25	
25A-A0T1N114	3.0	2.2	3.0	2.2	11.0	6.0	22.9	B	100-C37	32	50	140M-F8E-C25	140G-G6C3-C35	140G-G6C3-C35	140M-F8E-C25	140M-F8E-C25	

- (1) When the drive is controlling motors with lower amp ratings, refer to the drive nameplate for drive input current rating.
- (2) The AIC ratings of the Bulletin 140M Motor Protector Circuit Breakers may vary. See [Bulletin 140M Motor Protection Circuit Breakers Application Ratings](#).
- (3) Bulletin 140M with adjustable current ranges should have the current trip set to the minimum range that the device will not trip.
- (4) Manual Self-Protected (Type E) Combination Motor Controller, UL listed for 480V/277 and 600V/347 AC input. Not UL listed for use on 480V or 600V Delta/Delta, corner ground, or high-resistance ground systems.

Fuses and Circuit Breakers for PowerFlex 520-Series Drives (continued)

200...240V 3-Phase Input Protection Devices – Frames A...E

Catalog No. (1)		Output Ratings						Input Ratings		Frame Size	Contactor Catalog No.	IEC Applications (Non-UL)			UL Applications			Min. Enclosure Vol. (In.³)	
		ND	HP	KW	HP	HD	Amps	KVA	Max Amps (2)			Fuses (Rating)	Circuit Breakers	Fuses (Max. Rating)	Circuit Breakers	Fuses (Max. Rating)	Circuit Breakers		
PF 523	PF 525	HP	KW	KW	HP	HD	Amps	KVA	Max Amps (2)			Min.	Max.	140U/140G	140M	Class / Catalog No.	140U/140G	140M (3)(4)(5)	
25A-B1P6N104	–	0.25	0.2	0.2	0.25	0.2	1.6	0.9	1.9	A	100-C09	3	6	140U-D6D3-B30	140M-CZE-B25	CLASS RK5, CC, J, or T / DLS-R-15	140U-D6D3-B30	140M-CZE-B25	–
25A-B2P5N104	25B-B2P5N104	0.5	0.4	0.4	0.5	0.4	2.5	1.2	2.7	A	100-C09	6	6	140U-D6D3-B40	140M-CZE-B40	CLASS RK5, CC, J, or T / DLS-R-6	140U-D6D3-B40	140M-CZE-B40	–
25A-B5P0N104	25B-B5P0N104	1.0	0.75	1.0	1.0	0.75	5.0	2.7	5.8	A	100-C09	10	16	140U-D6D3-B80	140M-CZE-B63	CLASS RK5, CC, J, or T / DLS-R-15	140U-D6D3-B80	140M-CZE-B63	–
25A-B8P0N104	25B-B8P0N104	2.0	1.5	2.0	2.0	1.5	8.0	4.3	9.5	A	100-C12	16	20	140U-D6D3-C10	140M-CZE-C10	CLASS RK5, CC, J, or T / DLS-R-20	140U-D6D3-C10	140M-CZE-C10	–
25A-B011N104	25B-B011N104	3.0	2.2	3.0	3.0	2.2	11.0	6.3	13.8	A	100-C23	20	32	140U-D6D3-C15	140M-CZE-C16	CLASS RK5, CC, J, or T / DLS-R-30	140U-D6D3-C15	140M-CZE-C16	–
25A-B077N104	25B-B077N104	5.0	4.0	5.0	5.0	4.0	17.5	9.6	21.1	B	100-C23	32	45	140U-D6D3-C25	140M-F8E-C25	CLASS CC, J, or T / 45	140U-D6D3-C25	140M-F8E-C25	–
25A-B024N104	25B-B024N104	7.5	5.5	7.5	7.5	5.5	24.0	12.2	26.6	C	100-C37	35	63	140G-G6C3-C35	140M-F8E-C32	CLASS CC, J, or T / 60	–	140M-F8E-C32	–
25A-B032N104	25B-B032N104	10.0	7.5	10.0	10.0	7.5	32.2	15.9	34.8	D	100-C43	45	70	140G-G6C3-C60	140M-F8E-C45	CLASS RK5, CC, J, or T / DLS-R-70	–	140M-F8E-C45	–
25A-B048N104	25B-B048N104	15.0	11.0	15.0	15.0	11.0	48.3	20.1	44.0	E	100-C60	63	90	140G-G6C3-C70	140M-F8E-C45	CLASS CC, J, or T / 90	–	140M-F8E-C45	1416.0 (6)
25A-B062N104	25B-B062N104	20.0	15.0	20.0	20.0	15.0	62.1	25.6	56.0	E	100-C72	70	125	140G-G6C3-C90	–	CLASS CC, J, or T / 125	–	–	–

- (1) ■ Normal Duty (ND) and Heavy Duty (HD) ratings are available for this drive.
- (2) When the drive is controlling motors with lower amp ratings, refer to the drive nameplate for drive input current rating.
- (3) The AIC ratings of the Bulletin 140M Motor Protector Circuit Breakers may vary. See [Bulletin 140M Motor Protection Circuit Breakers Application Ratings](#).
- (4) Bulletin 140M with adjustable current range should have the current trip set to the minimum range that the device will not trip.
- (5) Manual Self-Protected (Type E) Combination Motor Controller, UL listed for 480Y/277 and 600Y/347 AC input. Not UL listed for use on 480V or 600V Delta/Star, corner ground, or high-resistance ground systems.
- (6) When using a Manual Self-Protected (Type E) Combination Motor Controller with this drive power rating, the drive must be installed in a ventilated or non-ventilated enclosure with the minimum volume specified in this column. Application specific thermal considerations may require a larger enclosure.

Fuses and Circuit Breakers for PowerFlex 520-Series Drives (continued)

380...480V 3-Phase Input Protection Devices – Frames A...E

Catalog No. (1)		Output Ratings						Input Ratings		Frame Size	Contactor Catalog No.	IEC Applications (Non-UL)		UL Applications					
		PF 525	ND	HP	KW	HP	HD	Amps	KVA			Max Amps (2)	Fuses (Rating)	Circuit Breakers	Fuses (Max. Rating)	Circuit Breakers	Min. Enclosure Vol. (In. 3)		
PF 523	PF 525		HP	KW	HP	HD	KW	Amps	KVA	Max Amps (2)		Min.	Max.	140M	140U/140G	140U/140G	140M-3(4)(5)	Min. Enclosure Vol. (In. 3)	
25A-D1P4N104	25B-D1P4N104	0.5	0.4	0.5	0.4	0.5	0.4	1.4	1.7	1.9	A	100-C09	3	6	140U-D6D3-B30	140M-CZE-B25	CLASS RK5, CC, J, or T / DLS-R-6	140M-CZE-B25	–
25A-D1P4N114	25B-D1P4N114	0.5	0.4	0.5	0.4	0.5	0.4	1.4	1.7	1.9	A	100-C09	3	6	140U-D6D3-B30	140M-CZE-B25	CLASS RK5, CC, J, or T / DLS-R-6	140M-CZE-B25	–
25A-D2P3N104	25B-D2P3N104	1.0	0.75	1.0	0.75	1.0	0.75	2.3	2.9	3.2	A	100-C09	6	10	140U-D6D3-B60	140M-CZE-B40	CLASS RK5, CC, J, or T / DLS-R-10	140M-CZE-B40	–
25A-D2P3N114	25B-D2P3N114	1.0	0.75	1.0	0.75	1.0	0.75	2.3	2.9	3.2	A	100-C09	6	10	140U-D6D3-B60	140M-CZE-B40	CLASS RK5, CC, J, or T / DLS-R-10	140M-CZE-B40	–
25A-D4P0N104	25B-D4P0N104	2.0	1.5	2.0	1.5	2.0	1.5	4.0	5.2	5.7	A	100-C09	10	16	140U-D6D3-B60	140M-CZE-B63	CLASS RK5, CC, J, or T / DLS-R-15	140M-CZE-B63	–
25A-D4P0N114	25B-D4P0N114	2.0	1.5	2.0	1.5	2.0	1.5	4.0	5.2	5.7	A	100-C09	10	16	140U-D6D3-B60	140M-CZE-B63	CLASS RK5, CC, J, or T / DLS-R-15	140M-CZE-B63	–
25A-D6P0N104	25B-D6P0N104	3.0	2.2	3.0	2.2	3.0	2.2	6.0	6.9	7.5	A	100-C09	10	16	140U-D6D3-C10	140M-CZE-C10	CLASS RK5, CC, J, or T / DLS-R-15	140M-CZE-C10	–
25A-D6P0N114	25B-D6P0N114	3.0	2.2	3.0	2.2	3.0	2.2	6.0	6.9	7.5	A	100-C09	10	16	140U-D6D3-C10	140M-CZE-C10	CLASS RK5, CC, J, or T / DLS-R-15	140M-CZE-C10	–
25A-D010N104	25B-D010N104	5.0	4.0	5.0	4.0	5.0	4.0	10.5	12.6	13.8	B	100-C23	20	32	140U-D6D3-C15	140M-CZE-C16	CLASS RK5, CC, J, or T / DLS-R-30	140M-CZE-C16	–
25A-D010N114	25B-D010N114	5.0	4.0	5.0	4.0	5.0	4.0	10.5	12.6	13.8	B	100-C23	20	32	140U-D6D3-C15	140M-CZE-C16	CLASS RK5, CC, J, or T / DLS-R-30	140M-CZE-C16	–
25A-D013N104	25B-D013N104	7.5	5.5	7.5	5.5	7.5	5.5	13.0	14.1	15.4	C	100-C23	20	35	140U-D6D3-C25	140M-D8E-C20	CLASS CC, J, or T / 35	140M-D8E-C20	–
25A-D013N114	25B-D013N114	7.5	5.5	7.5	5.5	7.5	5.5	13.0	14.1	15.4	C	100-C23	20	35	140U-D6D3-C25	140M-D8E-C20	CLASS CC, J, or T / 35	140M-D8E-C20	–
25A-D017N104	25B-D017N104	10.0	7.5	10.0	7.5	10.0	7.5	17.0	16.8	18.4	C	100-C23	25	40	140U-D6D3-C25	140M-D8E-C20	CLASS CC, J, or T / 40	140M-D8E-C20	–
25A-D017N114	25B-D017N114	10.0	7.5	10.0	7.5	10.0	7.5	17.0	16.8	18.4	C	100-C23	25	40	140U-D6D3-C25	140M-D8E-C20	CLASS CC, J, or T / 40	140M-D8E-C20	–
25A-D024N104	25B-D024N104	15.0	11.0	15.0	11.0	15.0	11.0	24.0	24.1	26.4	D	100-C37	35	63	140G-G6C3-C40	140M-F8E-C32	CLASS CC, J, or T / 60	140M-F8E-C32	65.6,7(6)
25A-D024N114	25B-D024N114	15.0	11.0	15.0	11.0	15.0	11.0	24.0	24.1	26.4	D	100-C37	35	63	140G-G6C3-C40	140M-F8E-C32	CLASS CC, J, or T / 60	140M-F8E-C32	65.6,7(6)
25A-D030N104	25B-D030N104	20.0	15.0	20.0	15.0	20.0	15.0	30.0	30.2	33.0	D	100-C43	45	70	140G-G6C3-C50	140M-F8E-C45	CLASS CC, J, or T / 70	140M-F8E-C45	65.6,7(6)
25A-D030N114	25B-D030N114	20.0	15.0	20.0	15.0	20.0	15.0	30.0	30.2	33.0	D	100-C43	45	70	140G-G6C3-C50	140M-F8E-C45	CLASS CC, J, or T / 70	140M-F8E-C45	65.6,7(6)
25A-D037N114	25B-D037N114	25.0	18.5	20.0	15.0	20.0	15.0	37.0	30.8	33.7	E	100-C43	45	70	140G-G6C3-C50	140M-F8E-C45	CLASS CC, J, or T / 70	140M-F8E-C45	–
25A-D043N114	25B-D043N114	30.0	22.0	25.0	18.5	25.0	18.5	43.0	35.6	38.9	E	100-C60	50	80	140G-G6C3-C60	140M-F8E-C45	CLASS CC, J, or T / 80	140M-F8E-C45	–

- (1) Normal Duty (ND) and Heavy Duty (HD) ratings are available for this drive.
- (2) When the drive is controlling motors with lower amp ratings, refer to the drive nameplate for drive input current rating.
- (3) The AC ratings of the Bulletin 140M Motor Protector Circuit Breakers may vary. See Bulletin 140M Motor Protection Circuit Breakers Application Ratings.
- (4) Bulletin 140M with adjustable current range should have the current trip set to the minimum range that the device will not trip.
- (5) Manual Self-Protected (Type E) Combination Motor Controller, UL listed for 480Y/277 and 600Y/347 AC input. Not UL listed for use on 480V or 600V Delta/Delta, corner ground, or high-resistance ground systems.
- (6) When using a Manual Self-Protected (Type E) Combination Motor Controller with this drive power rating, the drive must be installed in a ventilated or non-ventilated enclosure with the minimum volume specified in this column. Application specific thermal considerations may require a larger enclosure.

Fuses and Circuit Breakers for PowerFlex 520-Series Drives (continued)

525...600V 3-Phase Input Protection Devices – Frames A...E

Catalog No. (1)		Output Ratings						Input Ratings		Frame Size	Contactor Catalog No.	IEC Applications (Non-UL)			UL Applications			Min. Enclosure Vol. (In.³)											
		ND	HP	KW	HP	HD	Amps	KVA	Max Amps (2)			Fuses (Rating)	Circuit Breakers	Fuses (Max. Rating)	Circuit Breakers	Fuses (Max. Rating)	Circuit Breakers												
PF 523	PF 525	HP	KW	KW	HP	HP	KW	Amps	Max Amps (2)			Min.	Max.	140U/140G	140M	140U/140G	140M	140U/140G	140M	140U/140G	140M	140U/140G	140M	140U/140G	140M	140U/140G	140M	140U/140G	
25A-E0P9N104	25B-E0P9N104	0.5	0.4	0.4	0.5	0.4	0.5	0.9	1.4	1.2	A	3	6	140U-D6D3-B20	140M-CZE-B25	140U-D6D3-B20	140M-CZE-B25	140U-D6D3-B20	140M-CZE-B25	140U-D6D3-B20	140M-CZE-B25	140U-D6D3-B20	140M-CZE-B25	140U-D6D3-B20	140M-CZE-B25	140U-D6D3-B20	140M-CZE-B25	140U-D6D3-B20	140M-CZE-B25
25A-E1P7N104	25B-E1P7N104	1.0	0.75	1.0	1.0	0.75	1.0	1.7	2.6	2.3	A	3	6	140U-D6D3-B30	140M-CZE-B25	140U-D6D3-B30	140M-CZE-B25	140U-D6D3-B30	140M-CZE-B25	140U-D6D3-B30	140M-CZE-B25	140U-D6D3-B30	140M-CZE-B25	140U-D6D3-B30	140M-CZE-B25	140U-D6D3-B30	140M-CZE-B25	140U-D6D3-B30	140M-CZE-B25
25A-E3P0N104	25B-E3P0N104	2.0	1.5	2.0	2.0	1.5	2.0	3.0	4.3	3.8	A	6	10	140U-D6D3-B50	140M-CZE-B40	140U-D6D3-B50	140M-CZE-B40	140U-D6D3-B50	140M-CZE-B40	140U-D6D3-B50	140M-CZE-B40	140U-D6D3-B50	140M-CZE-B40	140U-D6D3-B50	140M-CZE-B40	140U-D6D3-B50	140M-CZE-B40	140U-D6D3-B50	140M-CZE-B40
25A-E4P2N104	25B-E4P2N104	3.0	2.2	3.0	3.0	2.2	3.0	4.2	6.1	5.3	A	10	16	140U-D6D3-B80	140M-CZE-B63	140U-D6D3-B80	140M-CZE-B63	140U-D6D3-B80	140M-CZE-B63	140U-D6D3-B80	140M-CZE-B63	140U-D6D3-B80	140M-CZE-B63	140U-D6D3-B80	140M-CZE-B63	140U-D6D3-B80	140M-CZE-B63	140U-D6D3-B80	140M-CZE-B63
25A-E6P6N104	25B-E6P6N104	5.0	4.0	5.0	5.0	4.0	5.0	6.6	9.1	8.0	B	20	25	140U-D6D3-C10	140M-CZE-C10	140U-D6D3-C10	140M-CZE-C10	140U-D6D3-C10	140M-CZE-C10	140U-D6D3-C10	140M-CZE-C10	140U-D6D3-C10	140M-CZE-C10	140U-D6D3-C10	140M-CZE-C10	140U-D6D3-C10	140M-CZE-C10	140U-D6D3-C10	140M-CZE-C10
25A-E9P9N104	25B-E9P9N104	7.5	5.5	7.5	7.5	5.5	7.5	9.9	12.8	11.2	C	16	25	140U-D6D3-C15	140M-CZE-C16	140U-D6D3-C15	140M-CZE-C16	140U-D6D3-C15	140M-CZE-C16	140U-D6D3-C15	140M-CZE-C16	140U-D6D3-C15	140M-CZE-C16	140U-D6D3-C15	140M-CZE-C16	140U-D6D3-C15	140M-CZE-C16	140U-D6D3-C15	140M-CZE-C16
25A-E012N104	25B-E012N104	10.0	7.5	10.0	10.0	7.5	10.0	12.0	15.4	13.5	C	20	32	140G-G6C3-C20	140M-F8E-C25	140G-G6C3-C20	140M-F8E-C25	140G-G6C3-C20	140M-F8E-C25	140G-G6C3-C20	140M-F8E-C25	140G-G6C3-C20	140M-F8E-C25	140G-G6C3-C20	140M-F8E-C25	140G-G6C3-C20	140M-F8E-C25	140G-G6C3-C20	140M-F8E-C25
25A-E019N104	25B-E019N104	15.0	11.0	15.0	15.0	11.0	15.0	19.0	27.4	24.0	D	30	50	140G-G6C3-C30	140M-F8E-C32	140G-G6C3-C30	140M-F8E-C32	140G-G6C3-C30	140M-F8E-C32	140G-G6C3-C30	140M-F8E-C32	140G-G6C3-C30	140M-F8E-C32	140G-G6C3-C30	140M-F8E-C32	140G-G6C3-C30	140M-F8E-C32	140G-G6C3-C30	140M-F8E-C32
25A-E022N104	25B-E022N104	20.0	15.0	20.0	20.0	15.0	20.0	22.0	31.2	27.3	D	35	63	140G-G6C3-C35	140M-F8E-C32	140G-G6C3-C35	140M-F8E-C32	140G-G6C3-C35	140M-F8E-C32	140G-G6C3-C35	140M-F8E-C32	140G-G6C3-C35	140M-F8E-C32	140G-G6C3-C35	140M-F8E-C32	140G-G6C3-C35	140M-F8E-C32	140G-G6C3-C35	140M-F8E-C32
25A-E027N104	25B-E027N104	25.0	18.5	25.0	25.0	18.5	25.0	27.0	38.2	34.7	E	35	50	140G-G6C3-C35	140M-F8E-C32	140G-G6C3-C35	140M-F8E-C32	140G-G6C3-C35	140M-F8E-C32	140G-G6C3-C35	140M-F8E-C32	140G-G6C3-C35	140M-F8E-C32	140G-G6C3-C35	140M-F8E-C32	140G-G6C3-C35	140M-F8E-C32	140G-G6C3-C35	140M-F8E-C32
25A-E032N104	25B-E032N104	30.0	22.0	30.0	30.0	22.0	30.0	32.0	43.4	39.2	E	40	63	140G-G6C3-C50	140M-F8E-C32	140G-G6C3-C50	140M-F8E-C32	140G-G6C3-C50	140M-F8E-C32	140G-G6C3-C50	140M-F8E-C32	140G-G6C3-C50	140M-F8E-C32	140G-G6C3-C50	140M-F8E-C32	140G-G6C3-C50	140M-F8E-C32	140G-G6C3-C50	140M-F8E-C32

- (1) Normal Duty (ND) and Heavy Duty (HD) ratings are available for this drive.
- (2) When the drive is controlling motors with lower amp ratings, refer to the drive nameplate for drive input current rating.
- (3) The ALC ratings of the Bulletin 140M Motor Protector Circuit Breakers may vary. See [Bulletin 140M Motor Protection Circuit Breakers Application Ratings](#).
- (4) Bulletin 140M with adjustable current range should have the current trip set to the minimum range that the device will not trip.
- (5) Manual Self-Protected (Type E) Combination Motor Controller, UL listed for 480Y/277 and 600Y/347 AC input. Not UL listed for use on 480V or 600V Delta/Delta, corner ground, or high-resistance ground systems.
- (6) When used with the 140M circuit breaker, the 25A-E9P9104 must be installed in a ventilated or non-ventilated enclosure with the minimum size of 457.2 x 457.2 x 269.8 mm (18 x 18 x 10.62 in.).
- (7) When using a Manual Self-Protected (Type E) Combination Motor Controller with this drive power rating, the drive must be installed in a ventilated or non-ventilated enclosure with the minimum volume specified in this column. Application specific thermal considerations may require a larger enclosure.

Power and Control Module

PowerFlex 520-series drives consist of a Power Module and Control Module.

Separating the Power and Control Module



ATTENTION: Perform this action only when drive is NOT powered.

1. Press and hold down the catch on both sides of the frame cover, then pull out and swing upwards to remove (Frames B...E only).

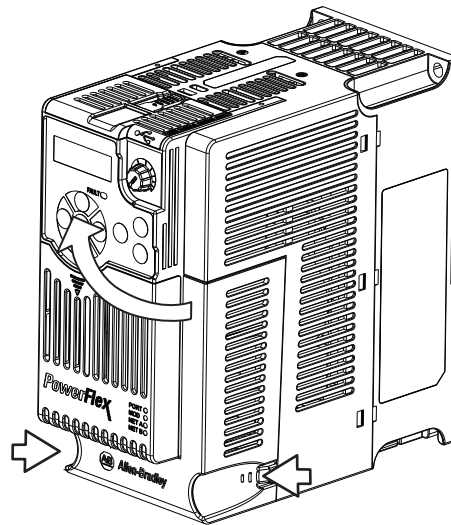

2. Press down and slide out the top cover of the Control Module to unlock it from the Power Module.

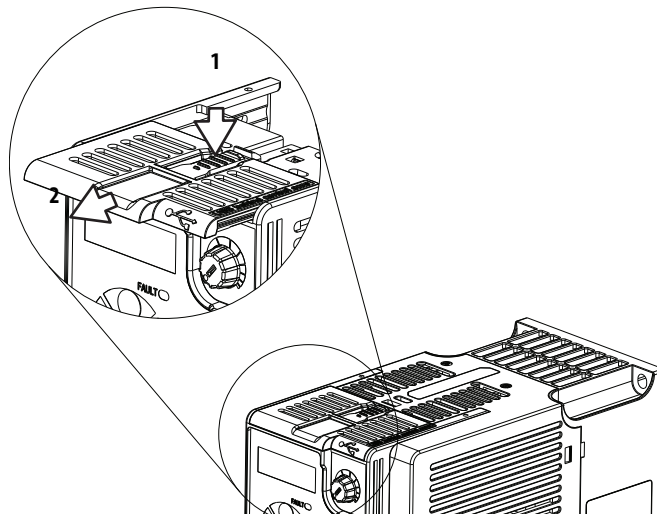

3. Hold the sides and top of the Control Module firmly, then pull out to separate it from the Power Module.

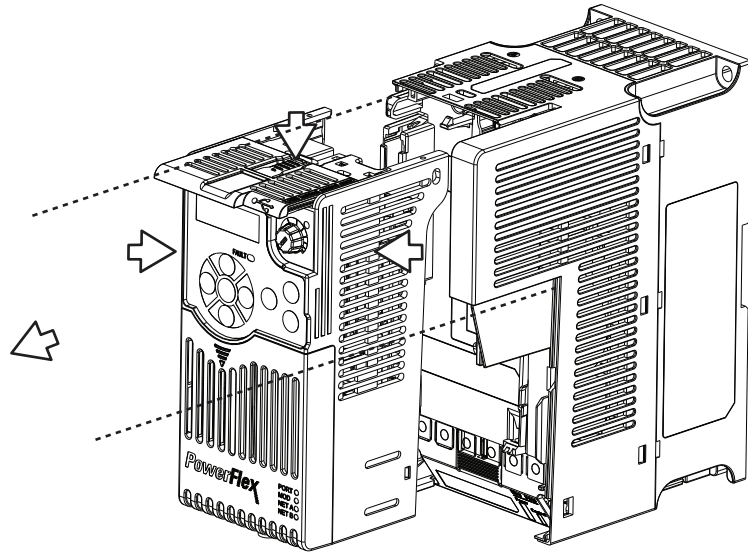

Connecting the Power and Control Module

1. Align the connectors on the Power Module and Control Module, then push the Control Module firmly onto the Power Module.

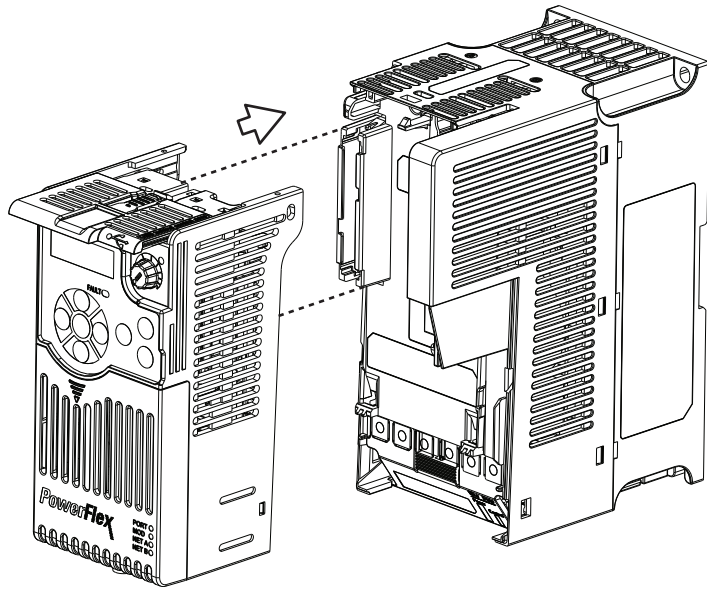

- 2. Push the top cover of the Control Module towards the Power Module to lock it.

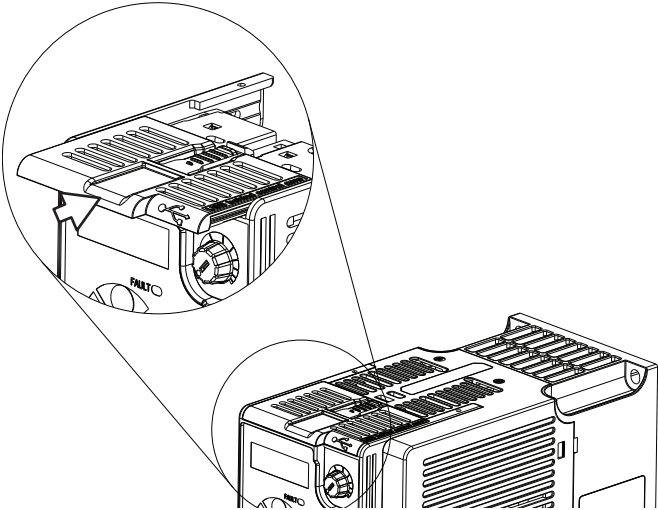

- 3. Insert the catch at the top of the frame cover into the Power Module, then swing the frame cover to snap the side catches onto the Power Module (Frames B...E only).

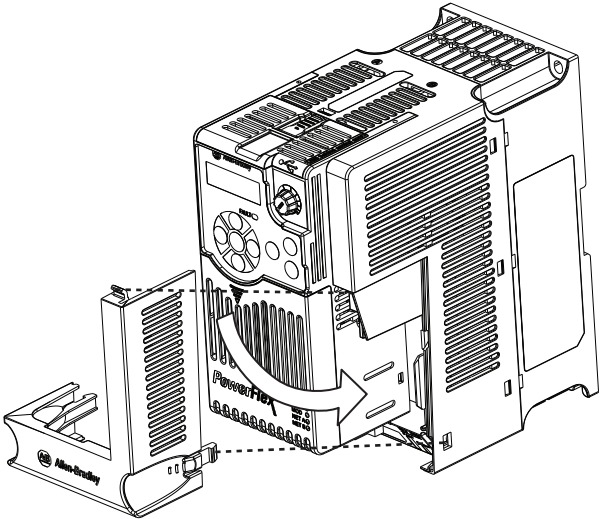

Control Module Cover

To access the control terminals, DSI port, and Ethernet port, the front cover must be removed. To remove:

1. Press and hold down the arrow on the front of the cover.
2. Slide the front cover down to remove from the Control Module.

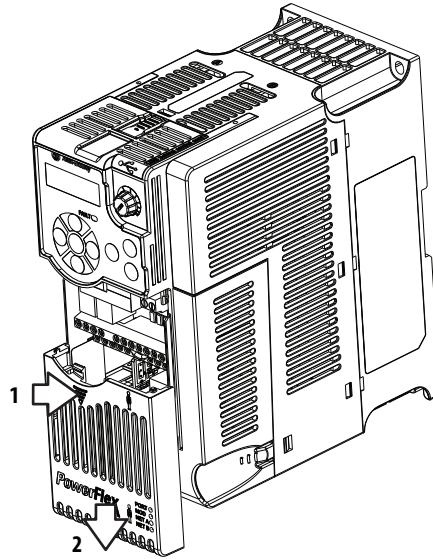

Re-attach the front cover when wiring is complete.

Power Module Terminal Guard

To access the power terminals, the terminal guard must be removed. To remove:

1. Press and hold down the catch on both sides of the frame cover, then pull out and swing upwards to remove (Frames B...E only).

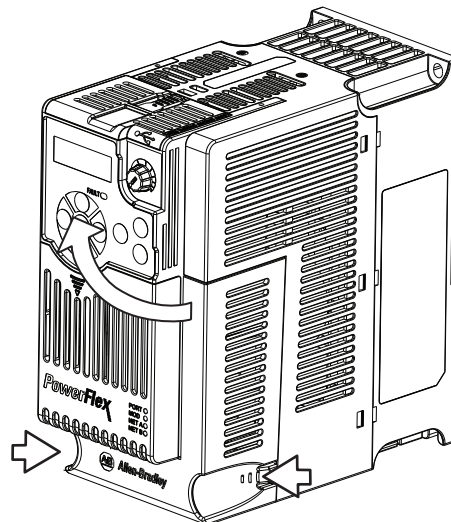

2. Press and hold down the locking tab on the terminal guard.
3. Slide the terminal guard down to remove from the Power Module.

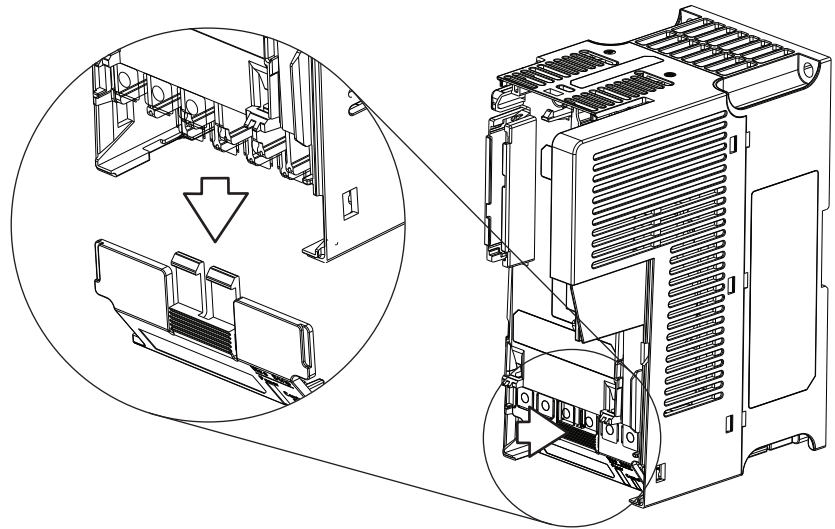

Re-attach the terminal guard when wiring is complete.

To access the power terminals for Frame A, you need to separate the Power and Control Modules. See [Separating the Power and Control Module on page 27](#) for instructions.

Power Wiring



ATTENTION: National Codes and standards (NEC, VDE, BSI, etc.) and local codes outline provisions for safely installing electrical equipment. Installation must comply with specifications regarding wire types, conductor sizes, branch circuit protection and disconnect devices. Failure to do so may result in personal injury and/or equipment damage.

ATTENTION: To avoid a possible shock hazard caused by induced voltages, unused wires in the conduit must be grounded at both ends. For the same reason, if a drive sharing a conduit is being serviced or installed, all drives using this conduit should be disabled. This will help minimize the possible shock hazard from “cross coupled” power leads.

Motor Cable Types Acceptable for 100...600 Volt Installations

A variety of cable types are acceptable for drive installations. For many installations, unshielded cable is adequate, provided it can be separated from sensitive circuits. As an approximate guide, allow a spacing of 0.3 m (1 ft) for every 10 m (32.8 ft) of length. In all cases, long parallel runs must be avoided. Do not use cable with an insulation thickness less than 15 mils (0.4 mm/0.015 in.). Do not route more than three sets of motor leads in a single conduit to minimize “cross talk”. If more than three drive/motor connections per conduit are required, shielded cable must be used.

UL installations above 50 °C ambient must use 600V, 90 °C wire.
UL installations in 50 °C ambient must use 600V, 75 °C or 90 °C wire.
UL installations in 40 °C ambient should use 600V, 75 °C or 90 °C wire.
Use copper wire only. Wire gauge requirements and recommendations are based on 75 °C. Do not reduce wire gauge when using higher temperature wire.



WARNING: The distance between the drive and motor must not exceed the maximum cable length stated in the Motor Cable Length Restrictions Tables in “Wiring and Grounding Guide, (PWM) AC Drives,” publication [DRIVES-IN001](#).

Unshielded

THHN, THWN or similar wire is acceptable for drive installation in dry environments provided adequate free air space and/or conduit fill rates limits are provided. Any wire chosen must have a minimum insulation thickness of 15 mils and should not have large variations in insulation concentricity.



ATTENTION: Do not use THHN or similarly coated wire in wet areas.

Shielded/Armored Cable

Shielded cable contains all of the general benefits of multi-conductor cable with the added benefit of a copper braided shield that can contain much of the noise generated by a typical AC Drive. Strong consideration for shielded cable should be given in installations with sensitive equipment such as weigh scales, capacitive proximity switches and other devices that may be affected by electrical noise in the distribution system. Applications with large numbers of drives in a similar location, imposed EMC regulations or a high degree of communications / networking are also good candidates for shielded cable.

Shielded cable may also help reduce shaft voltage and induced bearing currents for some applications. In addition, the increased impedance of shielded cable may help extend the distance that the motor can be located from the drive without the addition of motor protective devices such as terminator networks. Refer to Reflected Wave in “Wiring and Grounding Guide, (PWM) AC Drives,” publication [DRIVES-IN001](#).

Consideration should be given to all of the general specifications dictated by the environment of the installation, including temperature, flexibility, moisture characteristics and chemical resistance. In addition, a braided shield should be included and be specified by the cable manufacturer as having coverage of at least 75%. An additional foil shield can greatly improve noise containment.

A good example of recommended cable is Belden® 295xx (xx determines gauge). This cable has four (4) XLPE insulated conductors with a 100% coverage foil and an 85% coverage copper braided shield (with drain wire) surrounded by a PVC jacket.

Other types of shielded cable are available, but the selection of these types may limit the allowable cable length. Particularly, some of the newer cables twist 4 conductors of THHN wire and wrap them tightly with a foil shield. This construction can greatly increase the cable charging current required and reduce the overall drive performance. Unless specified in the individual distance tables as tested with the drive, these cables are not recommended and their performance against the lead length limits supplied is not known.

Recommended Shielded Wire

Location	Rating/Type	Description
Standard (Option 1)	600V, 90 °C (194 °F) XHHW2/RHW-2 Anixter B209500-B209507, Belden 29501-29507, or equivalent	<ul style="list-style-type: none"> • Four tinned copper conductors with XLPE insulation. • Copper braid/aluminum foil combination shield and tinned copper drain wire. • PVC jacket.
Standard (Option 2)	Tray rated 600V, 90 °C (194 °F) RHH/RHW-2 Anixter OLF-7xxxx or equivalent	<ul style="list-style-type: none"> • Three tinned copper conductors with XLPE insulation. • 5 mil single helical copper tape (25% overlap min.) with three bare copper grounds in contact with shield. • PVC jacket.
Class I & II; Division I & II	Tray rated 600V, 90 °C (194 °F) RHH/RHW-2 Anixter 7V-7xxx-3G or equivalent	<ul style="list-style-type: none"> • Three bare copper conductors with XLPE insulation and impervious corrugated continuously welded aluminum armor. • Black sunlight resistant PVC jacket overall. • Three copper grounds on #10 AWG and smaller.

Reflected Wave Protection

The drive should be installed as close to the motor as possible. Installations with long motor cables may require the addition of external devices to limit voltage reflections at the motor (reflected wave phenomena). Refer to Reflected Wave in “Wiring and Grounding Guide, (PWM) AC Drives,” publication [DRIVES-IN001](#).

The reflected wave data applies to all carrier frequencies 2...16 kHz.

For 240V ratings and lower, reflected wave effects do not need to be considered.

Output Disconnect

The drive is intended to be commanded by control input signals that will start and stop the motor. A device that routinely disconnects then reapplies output power to the motor for the purpose of starting and stopping the motor should not be used. If it is necessary to disconnect power to the motor with the drive outputting power, an auxiliary contact should be used to simultaneously disable drive (Aux Fault or Coast to Stop).

Power Terminal Block

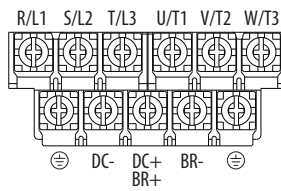

Power Terminal Block

Frame A, B, C & D

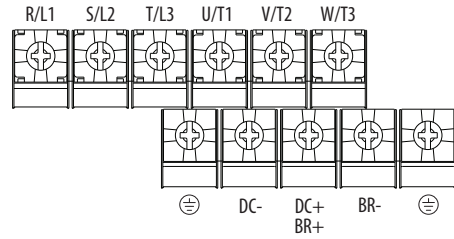

Frame E

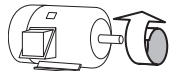

Terminal	Description
R/L1, S/L2	1-Phase Input Line Voltage Connection
R/L1, S/L2, T/L3	3-Phase Input Line Voltage Connection
U/T1, V/T2, W/T3	Motor Phase Connection =  Switch any two motor leads to change forward direction.
DC+, DC-	DC Bus Connection (except for 110V 1-Phase)
BR+, BR-	Dynamic Brake Resistor Connection
	Safety Ground - PE

IMPORTANT Terminal screws may become loose during shipment. Ensure that all terminal screws are tightened to the recommended torque before applying power to the drive.

Power Terminal Block Wire Specifications

Frame	Maximum Wire Size ⁽¹⁾	Minimum Wire Size ⁽¹⁾	Torque
A	5.3 mm ² (10 AWG)	0.8 mm ² (18 AWG)	1.76...2.16 Nm (15.6...19.1 lb-in.)
B	8.4 mm ² (8 AWG)	2.1 mm ² (14 AWG)	1.76...2.16 Nm (15.6...19.1 lb-in.)
C	8.4 mm ² (8 AWG)	2.1 mm ² (14 AWG)	1.76...2.16 Nm (15.6...19.1 lb-in.)
D	13.3 mm ² (6 AWG)	5.3 mm ² (10 AWG)	1.76...2.16 Nm (15.6...19.1 lb-in.)
E	26.7 mm ² (3 AWG)	8.4 mm ² (8 AWG)	3.09...3.77 Nm (27.3...33.4 lb-in.)

(1) Maximum/minimum sizes that the terminal block will accept – these are not recommendations.

Common Bus/Precharge Notes

If drives are used with a disconnect switch to the common DC bus, then an auxiliary contact on the disconnect must be connected to a digital input of the drive. The corresponding input (parameter [r062](#), [r063](#), [r065...r068](#) [DigIn TermBlk xx]) must be set to 30, “Precharge En” This provides the proper precharge interlock, guarding against possible damage to the drive when connected to a common DC bus.

I/O Wiring

Motor Start/Stop Precautions



ATTENTION: A contactor or other device that routinely disconnects and reapplies the AC line to the drive to start and stop the motor can cause drive hardware damage. The drive is designed to use control input signals that will start and stop the motor. If used, the input device must not exceed one operation per minute or drive damage can occur.

ATTENTION: The drive start/stop control circuitry includes solid-state components. If hazards due to accidental contact with moving machinery or unintentional flow of liquid, gas or solids exist, an additional hardwired stop circuit may be required to remove the AC line to the drive. When the AC line is removed, there will be a loss of any inherent regenerative braking effect that might be present - the motor will coast to a stop. An auxiliary braking method may be required. Alternatively, use the drive's safety input function.

Important points to remember about I/O wiring:

- Always use copper wire.
- Wire with an insulation rating of 600V or greater is recommended.
- Control and signal wires should be separated from power wires by at least 0.3 m (1 ft).

IMPORTANT I/O terminals labeled “Common” are not referenced to the safety ground (PE) terminal and are designed to greatly reduce common mode interference.



ATTENTION: Driving the 4-20 mA analog input from a voltage source could cause component damage. Verify proper configuration prior to applying input signals.

Signal and Control Wire Types

Recommendations are for 50 °C ambient temperature.
75 °C wire must be used for 60 °C ambient temperature.
90 °C wire must be used for 70 °C ambient temperature.

Recommended Signal Wire

Signal Type/ Where Used	Belden Wire Type(s) ⁽¹⁾ (or equivalent)	Description	Min. Insulation Rating
Analog I/O & PTC	8760/9460	0.750 mm ² (18 AWG), twisted pair, 100% shield with drain ⁽²⁾	300V, 60 °C (140 °F)
Remote Pot	8770	0.750 mm ² (18 AWG), 3 conductor, shielded	
Encoder/Pulse I/O	9728/9730	0.196 mm ² (24 AWG), individually shielded pairs	

(1) Stranded or solid wire.

(2) If the wires are short and contained within a cabinet which has no sensitive circuits, the use of shielded wire may not be necessary, but is always recommended.

Recommended Control Wire for Digital I/O

Type	Wire Type(s)	Description	Min. Insulation Rating
Unshielded	Per US NEC or applicable national or local code	–	300V, 60 °C (140 °F)
Shielded	Multi-conductor shielded cable such as Belden 8770 (or equivalent)	0.750 mm ² (18 AWG), 3 conductor, shielded.	

Maximum Control Wire Recommendations

Do not exceed control wiring length of 30 m (100 ft). Control signal cable length is highly dependent on electrical environment and installation practices. To improve noise immunity, the I/O terminal block Common may be connected to ground terminal/protective earth.

Control I/O Terminal Block

Control I/O Terminal Block Wire Specifications

Frame	Maximum Wire Size ⁽¹⁾	Minimum Wire Size ⁽¹⁾	Torque
A...E	1.3 mm ² (16 AWG)	0.13 mm ² (26 AWG)	0.71...0.86 Nm (6.2...7.6 lb-in.)

(1) Maximum/minimum sizes that the terminal block will accept – these are not recommendations.

PowerFlex 523 Control I/O Terminal Block

PowerFlex 523 Control I/O Wiring Block Diagram

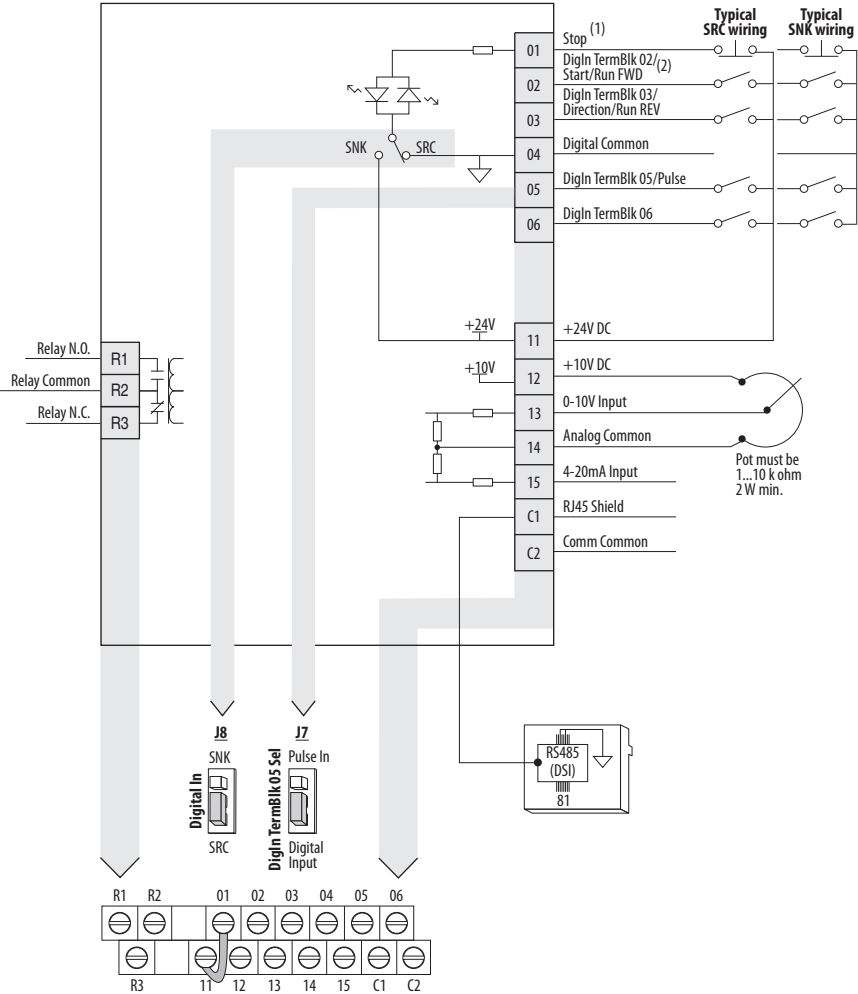

Control I/O Wiring Block Diagram Notes

(1) See [Digital Input Selection for Start Source on page 47](#) for more information on configuring the digital inputs.



IMPORTANT I/O Terminal 01 is always a stop input. The stopping mode is determined by the drive setting. See the tables below for more information.

Start Method	Stop Method	
P046, P048, P050 [Start Source x]	I/O Terminal 01 Stop	Normal Stop
1 "Keypad"	Coast	Per P045 [Stop Mode]
2 "DigIn TrmBlk"	See t062, t063 [DigIn TermBlk xx] below	
3 "Serial/DSI"	Coast	
4 "Network Opt"	Coast	
5 "Ethernet/IP" ⁽¹⁾	Coast	

(1) Setting is specific to PowerFlex 525 drives only.

Start Method	Stop Method	
t062, t063 [DigIn TermBlk xx]	I/O Terminal 01 Stop	Normal Stop
48 "2-Wire FWD"	t064 [2-Wire Mode] is set to: • 0, 1, or 2 = Coast • 3 = per P045 [Stop Mode]	Per P045 [Stop Mode]
49 "3-Wire Start"	Per P045 [Stop Mode]	
50 "2-Wire REV"	t064 [2-Wire Mode] is set to: • 0, 1, or 2 = Coast • 3 = per P045 [Stop Mode]	
51 "3-Wire Dir"	Per P045 [Stop Mode]	

IMPORTANT The drive is shipped with a jumper installed between I/O Terminals 01 and 11. Remove this jumper when using I/O Terminal 01 as a stop or enable input.

(2) Two wire control shown. For three wire control use a momentary input  on I/O Terminal 02 to command a start. Use a maintained input  for I/O Terminal 03 to change direction.

Control I/O Terminal Designations

No.	Signal	Default	Description	Parameter
R1	Relay N.O.	Fault	Normally open contact for output relay.	t076
R2	Relay Common	Fault	Common for output relay.	
R3	Relay N.C.	Motor Running	Normally closed contact for output relay.	t081
01	Stop	Coast	Three wire stop. However, it functions as a stop under all input modes and cannot be disabled.	P045 ⁽²⁾
02	DigIn TermBlk 02/ Start/Run FWD	Run FWD	Used to initiate motion and also can be used as a programmable digital input. It can be programmed with t062 [DigIn TermBlk 02] as three wire (Start/Dir with Stop) or two wire (Run FWD/ Run REV) control. Current consumption is 6 mA.	P045 , P046 , P048 , P050 , A544 , t062
03	DigIn TermBlk 03/ Dir/Run REV	Run REV	Used to initiate motion and also can be used as a programmable digital input. It can be programmed with t063 [DigIn TermBlk 03] as three wire (Start/Dir with Stop) or two wire (Run FWD/ Run REV) control. Current consumption is 6 mA.	t063
04	Digital Common	–	Return for digital I/O. Electrically isolated (along with the digital I/O) from the rest of the drive.	–
05	DigIn TermBlk 05/ Pulse In	Preset Freq	Program with t065 [DigIn TermBlk 05]. Also functions as a Pulse Train input for reference or speed feedback. The maximum frequency is 100 kHz. Current consumption is 6 mA.	t065
06	DigIn TermBlk 06	Preset Freq	Program with t066 [DigIn TermBlk 06]. Current consumption is 6 mA.	t066
11	+24V DC	–	Referenced to Digital Common. Drive supplied power for digital inputs. Maximum output current is 100 mA.	–
12	+10V DC	–	Referenced to Analog Common. Drive supplied power for 0...10V external potentiometer. Maximum output current is 15 mA.	P047 , P049
13	0-10V In ⁽¹⁾	Not Active	For external 0-10V (unipolar) input supply or potentiometer wiper. Input impedance: Voltage source = 100 kΩ Allowable potentiometer resistance range = 1...10 kΩ	P047 , P049 , t062 , t063 , t065 , t066 , t093 , A459 , A471
14	Analog Common	–	Return for the analog I/O. Electrically isolated (along with the analog I/O) from the rest of the drive.	–

Control I/O Terminal Designations

No.	Signal	Default	Description	Parameter
15	4-20mA In ⁽¹⁾	Not Active	For external 4-20 mA input supply. Input impedance = 250 Ω	P047 , P049 , t062 , t063 , t065 , t066 , A459 , A471
C1	C1	–	This terminal is tied to the RJ-45 port shield. Tie this terminal to a clean ground in order to improve noise immunity when using external communication peripherals.	–
C2	C2	–	This is the signal common for the communication signals.	–

- (1) Only one analog frequency source may be connected at a time. If more than one reference is connected at the same time, an undetermined frequency reference will result.
- (2) See Footnote (1) on [page 37](#).

PowerFlex 525 Control I/O Terminal Block

PowerFlex 525 Control I/O Wiring Block Diagram

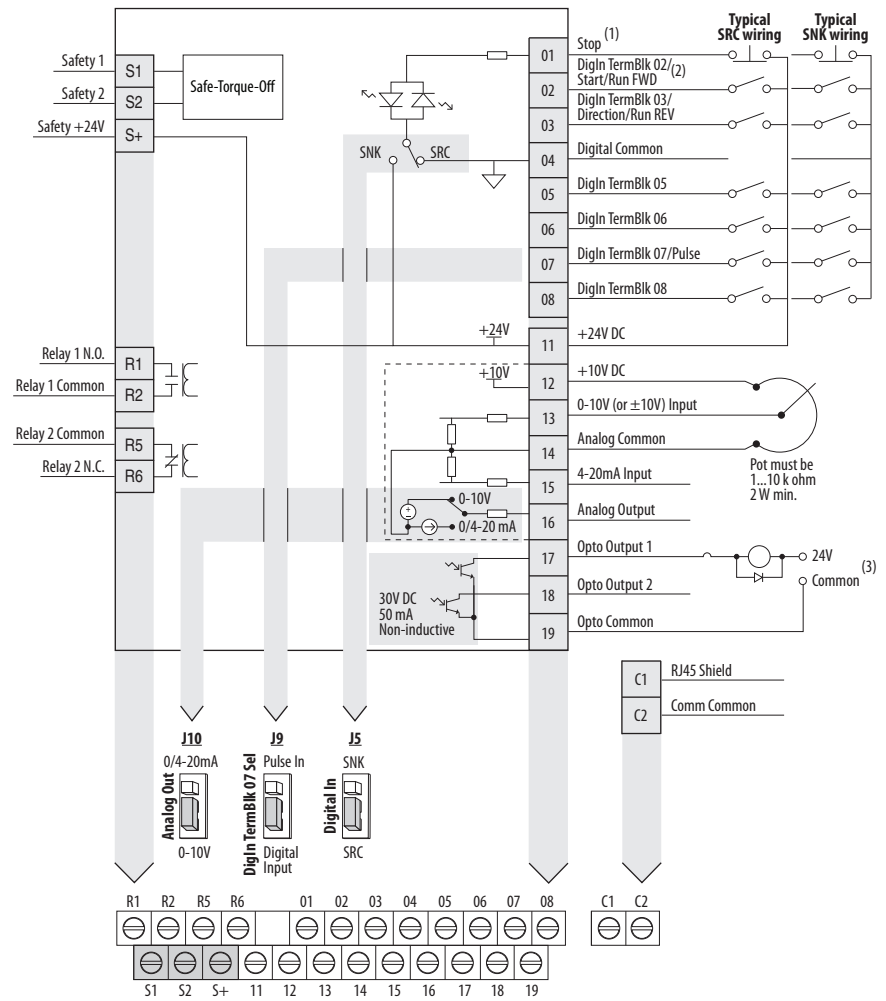

Control I/O Wiring Block Diagram Notes



(1) See [Digital Input Selection for Start Source on page 47](#) for more information on configuring the digital inputs.

IMPORTANT I/O Terminal 01 is always a stop input. The stopping mode is determined by the drive setting. See the tables below for more information.

Start Method	Stop Method	
P046, P048, P050 [Start Source x]	I/O Terminal 01 Stop	Normal Stop
1 "Keypad"	Coast	Per P045 [Stop Mode]
2 "DigIn TrmBlk"	See t062, t063 [DigIn TermBlk xx] below	
3 "Serial/DSI"	Coast	
4 "Network Opt"	Coast	
5 "EtherNet/IP"	Coast	

Start Method	Stop Method	
t062, t063 [DigIn TermBlk xx]	I/O Terminal 01 Stop	Normal Stop
48 "2-Wire FWD"	t064 [2-Wire Mode] is set to: • 0, 1, or 2 = Coast • 3 = per P045 [Stop Mode]	Per P045 [Stop Mode]
49 "3-Wire Start"	Per P045 [Stop Mode]	
50 "2-Wire REV"	t064 [2-Wire Mode] is set to: • 0, 1, or 2 = Coast • 3 = per P045 [Stop Mode]	
51 "3-Wire Dir"	Per P045 [Stop Mode]	

IMPORTANT The drive is shipped with a jumper installed between I/O Terminals 01 and 11. Remove this jumper when using I/O Terminal 01 as a stop or enable input.

- (2) Two wire control shown. For three wire control use a momentary input  on I/O Terminal 02 to command a start. Use a maintained input  for I/O Terminal 03 to change direction.
- (3) When using an opto output with an inductive load such as a relay, install a recovery diode parallel to the relay as shown, to prevent damage to the output.

Control I/O Terminal Designations

No.	Signal	Default	Description	Parameter
R1	Relay 1 N.O.	Fault	Normally open contact for output relay.	t076
R2	Relay 1 Common	Fault	Common for output relay.	
R5	Relay 2 Common	Motor Running	Common for output relay.	t081
R6	Relay 2 N.C.	Motor Running	Normally closed contact for output relay.	
01	Stop	Coast	Three wire stop. However, it functions as a stop under all input modes and cannot be disabled.	P045 ⁽¹⁾
02	DigIn TermBlk 02/ Start/Run FWD	Run FWD	Used to initiate motion and also can be used as a programmable digital input. It can be programmed with t062 [DigIn TermBlk 02] as three wire (Start/Dir with Stop) or two wire (Run FWD/Run REV) control. Current consumption is 6 mA.	P045, P046, P048, P050, A544, t062
03	DigIn TermBlk 03/ Dir/Run REV	Run REV	Used to initiate motion and also can be used as a programmable digital input. It can be programmed with t063 [DigIn TermBlk 03] as three wire (Start/Dir with Stop) or two wire (Run FWD/Run REV) control. Current consumption is 6 mA.	t063
04	Digital Common	—	Return for digital I/O. Electrically isolated (along with the digital I/O) from the rest of the drive.	—
05	DigIn TermBlk 05	Preset Freq	Program with t065 [DigIn TermBlk 05]. Current consumption is 6 mA.	t065

Control I/O Terminal Designations

No.	Signal	Default	Description	Parameter
06	DigIn TermBlk 06	Preset Freq	Program with t066 [DigIn TermBlk 06]. Current consumption is 6 mA.	t066
07	DigIn TermBlk 07/ Pulse In	Start Source 2 + Speed Reference2	Program with t067 [DigIn TermBlk 07]. Also functions as a Pulse Train input for reference or speed feedback. The maximum frequency is 100 kHz. Current consumption is 6 mA.	t067
08	DigIn TermBlk 08	Jog Forward	Program with t068 [DigIn TermBlk 08]. Current consumption is 6 mA.	t068
C1	C1	–	This terminal is tied to the RJ-45 port shield. Tie this terminal to a clean ground in order to improve noise immunity when using external communication peripherals.	–
C2	C2	–	This is the signal common for the communication signals.	–
S1	Safety 1	–	Safety input 1. Current consumption is 6 mA.	–
S2	Safety 2	–	Safety input 2. Current consumption is 6 mA.	–
S+	Safety +24V	–	+24V supply for safety circuit. Internally tied to the +24V DC source (Pin 11).	–
11	+24V DC	–	Referenced to Digital Common. Drive supplied power for digital inputs. Maximum output current is 100 mA.	–
12	+10V DC	–	Referenced to Analog Common. Drive supplied power for 0...10V external potentiometer. Maximum output current is 15 mA.	P047 , P049
13	±10V In	Not Active	For external 0-10V (unipolar) or ±10V (bipolar) input supply or potentiometer wiper. Input impedance: Voltage source = 100 k Ω Allowable potentiometer resistance range = 1...10 k Ω	P047 , P049 , t062 , t063 , t065 , t066 , t093 , A459 , A471
14	Analog Common	–	Return for the analog I/O. Electrically isolated (along with the analog I/O) from the rest of the drive.	–
15	4-20mA In	Not Active	For external 4-20 mA input supply. Input impedance = 250 Ω	P047 , P049 , t062 , t063 , t065 , t066 , A459 , A471
16	Analog Output	OutFreq 0-10	The default analog output is 0-10V. To convert a current value, change the Analog Output jumper to 0-20 mA. Program with t088 [Analog Out Sel]. Maximum analog value can be scaled with t089 [Analog Out High]. Maximum Load: 4-20 mA = 525 Ω (10.5V) 0-10V = 1 k Ω (10 mA)	t088 , t089
17	Opto Output 1	Motor Running	Program with t069 [Opto Out1 Sel]. Each Opto-Output is rated 30V DC 50 mA (Non-inductive).	t069 , t070 , t075
18	Opto Output 2	At Frequency	Program with t072 [Opto Out1 Sel]. Each Opto-Output is rated 30V DC 50 mA (Non-inductive).	t072 , t073 , t075
19	Opto Common	–	The emitters of the Optocoupler Outputs (1 and 2) are tied together at Optocoupler Common. Electrically isolated from the rest of the drive.	–

(1) See Footnote (1) on [page 37](#).

I/O Wiring Examples

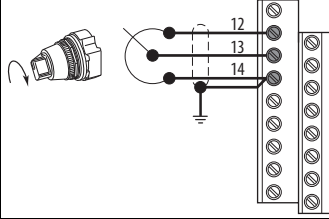
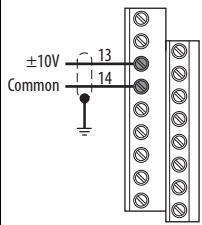
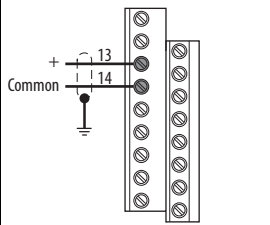
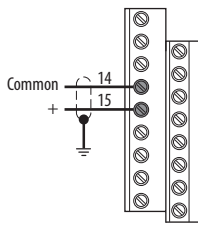
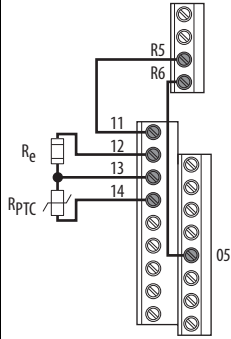
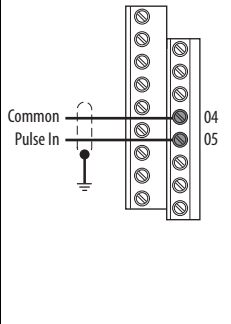
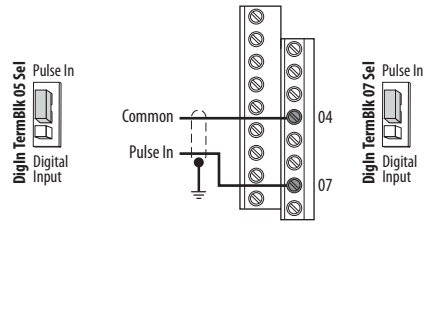
I/O	Connection Example		
<p>Potentiometer 1...10k Ω Pot. Recommended (2 W minimum)</p>	<p>P047 [Speed Reference1] = 5 "0-10V Input"</p> 		
<p>Analog Input 0-10V, 100k Ω impedance 4-20 mA, 250 Ω impedance</p>	<p>Bipolar P047 [Speed Reference1] = 5 "0-10V Input" and t093 [10V Bipolar Enbl] = 1 "Bi-Polar In"</p> 	<p>Unipolar (Voltage) P047 [Speed Reference1] = 5 "0-10V Input"</p> 	<p>Unipolar (Current) P047 [Speed Reference1] = 6 "4-20mA Input"</p> 
<p>Analog Input, PTC For Drive Fault</p>	<p>Wire the PTC and External Resistor (typically matched to the PTC Hot Resistance) to I/O Terminals 12, 13, 14. Wire R2/R3 Relay Output (SRC) to I/O Terminals 5 & 11. t065 [DigIn TermBlk 05] = 12 "Aux Fault" t081 [Relay Out 2 Sel] = 10 "Above Anlg V" t082 [Relay Out 2 Level] = % Voltage Trip</p>  <div data-bbox="1068 1262 1273 1329" style="border: 1px solid black; padding: 5px; width: fit-content; margin: 10px auto;"> $\%V_{\text{Trip}} = \frac{R_{\text{PTC}}(\text{hot})}{R_{\text{PTC}}(\text{hot}) + R_e} \times 100$ </div>		
<p>Pulse Train Input PowerFlex 523 t065 [DigIn TermBlk 05] = 52 PowerFlex 525 t067 [DigIn TermBlk 07] = 52 Use P047, P049 and P051 [Speed Referencex] to select pulse input. Jumper for DigIn TermBlk 05 or 07 Sel must be moved to Pulse In.</p>	<div style="display: flex; justify-content: space-around;"> <div data-bbox="802 1461 1031 1822"> <p>PowerFlex 523</p>  </div> <div data-bbox="1036 1461 1474 1822"> <p>PowerFlex 525</p>  </div> </div>		

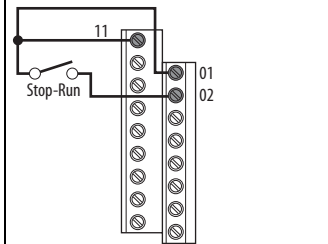
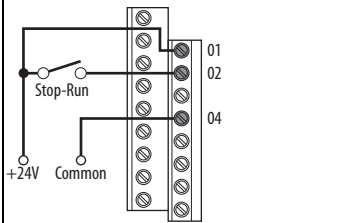
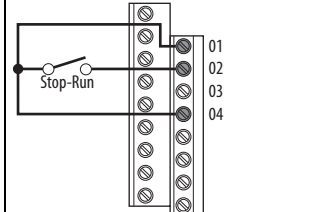
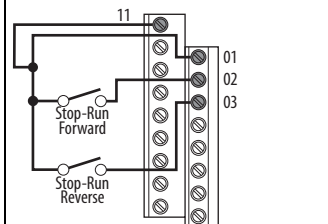
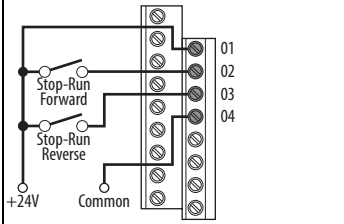
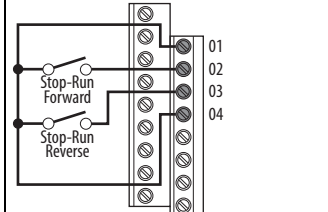
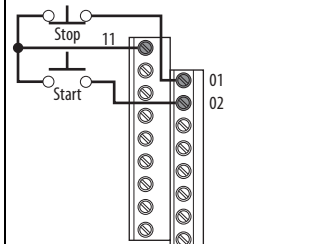
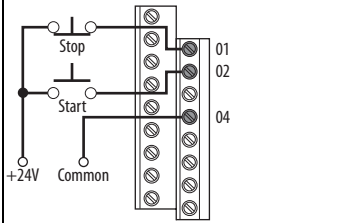
I/O	Connection Example	
<p>2 Wire SRC Control - Non-Reversing</p> <p>P046 [Start Source 1] = 2 and t062 [DigIn TermBlk 02] = 48</p> <p>Input must be active for the drive to run. When input is opened, the drive will stop as specified by P045 [Stop Mode].</p> <p>If desired, a User Supplied 24V DC power source can be used. Refer to the "External Supply (SRC)" example.</p>	<p>Internal Supply (SRC)</p> 	<p>External Supply (SRC)</p>  <p>Each digital input draws 6 mA.</p>
<p>2 Wire SNK Control - Non-Reversing</p>	<p>Internal Supply (SNK)</p> 	
<p>2 Wire SRC Control - Run FWD/Run REV</p> <p>P046 [Start Source 1] = 2, t062 [DigIn TermBlk 02] = 48 and t063 [DigIn TermBlk 03] = 50</p> <p>Input must be active for the drive to run. When input is opened, the drive will stop as specified by P045 [Stop Mode].</p> <p>If both Run Forward and Run Reverse inputs are closed at the same time, an undetermined state could occur.</p>	<p>Internal Supply (SRC)</p> 	<p>External Supply (SRC)</p>  <p>Each digital input draws 6 mA.</p>
<p>2 Wire SNK Control - Run FWD/Run REV</p>	<p>Internal Supply (SNK)</p> 	
<p>3 Wire SRC Control - Non-Reversing</p> <p>P046 [Start Source 1] = 2, t062 [DigIn TermBlk 02] = 49 and t063 [DigIn TermBlk 03] = 51</p> <p>A momentary input will start the drive. A stop input to I/O Terminal 01 will stop the drive as specified by P045 [Stop Mode].</p>	<p>Internal Supply (SRC)</p> 	<p>External Supply (SRC)</p>  <p>Each digital input draws 6 mA.</p>

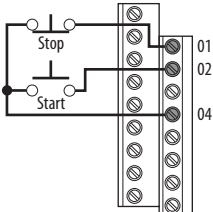
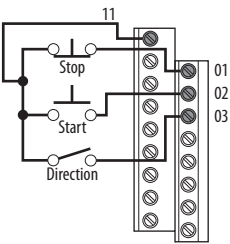
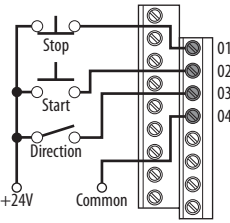
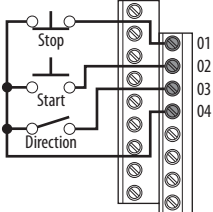
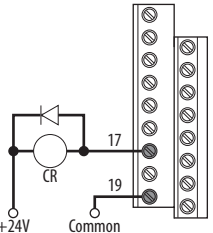
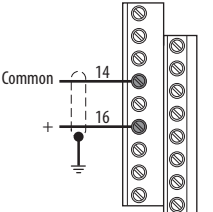
I/O	Connection Example	
<p>3 Wire SNK Control - Non-Reversing</p>	<p>Internal Supply (SNK)</p> 	
<p>3 Wire SRC Control - Reversing</p> <p>P046 [Start Source 1] = 2, t062 [DigIn TermBlk 02] = 49 and t063 [DigIn TermBlk 03] = 51</p> <p>A momentary input will start the drive. A stop input will stop the drive as specified by P045 [Stop Mode]. I/O Terminal 03 determines direction.</p>	<p>Internal Supply (SRC)</p> 	<p>External Supply (SRC)</p>  <p>Each digital input draws 6 mA.</p>
<p>3 Wire SNK Control - Reversing</p>	<p>Internal Supply (SNK)</p> 	
<p>Opto Output (1 & 2)⁽¹⁾</p> <p>t069 [Opto Out1 Sel] determines Opto-Output 1 (I/O Terminal 17) operation.</p> <p>t072 [Opto Out2 Sel] determines Opto-Output 2 (I/O Terminal 18) operation.</p> <p>When using Opto-Output with an inductive load such as a relay, install a recovery diode parallel to the relay as shown, to prevent damage to the output.</p>	<p>Opto-Output 1</p>  <p>Each Opto-Output is rated 30V DC 50 mA (Non-inductive).</p>	
<p>Analog Output⁽¹⁾</p> <p>t088 [Analog Out Sel] determines analog output type and drive conditions.</p> <p>0-10V, 1k Ω minimum 0-20 mA/4-20 mA, 525 Ω maximum</p>	<p>t088 [Analog Out Sel] = 0 through 23</p> <p>The Analog Output Select jumper must be set to match the analog output signal mode set in t088 [Analog Out Sel].</p> 	

(1) Feature is specific to PowerFlex 525 drives only.

Typical Multiple Drive Connection Examples

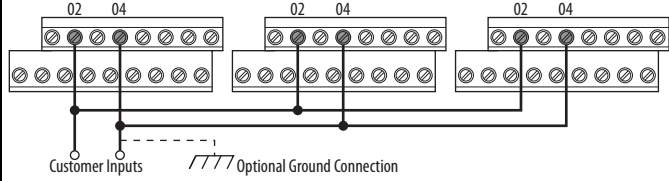
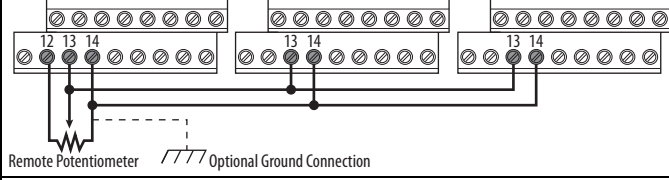
Input/Output	Connection Example
<p>Multiple Digital Input Connections Customer Inputs can be wired per External Supply (SRC).</p>	 <p>When connecting a single input such as Run, Stop, Reverse or Preset Speeds to multiple drives, it is important to connect I/O Terminal 04 common together for all drives. If they are to be tied into another common (such as earth ground or separate apparatus ground) only one point of the daisy chain of I/O Terminal 04 should be connected.</p> <p>ATTENTION: I/O Common terminals should not be tied together when using SNK (Internal Supply) mode. In SNK mode, if power is removed from one drive, inadvertent operation of other drives that share the same I/O Common connection may occur.</p>
<p>Multiple Analog Connections</p>	 <p>When connecting a single potentiometer to multiple drives it is important to connect I/O Terminal 14 common together for all drives. I/O Terminal 14 common and I/O Terminal 13 (potentiometer wiper) should be daisy-chained to each drive. All drives must be powered up for the analog signal to be read correctly.</p>

Start and Speed Reference Control

Start Source and Speed Reference Selection

The start and drive speed command can be obtained from a number of different sources. By default, start source is determined by [P046](#) [Start Source 1] and drive speed source is determined by [P047](#) [Speed Reference1]. However, various inputs can override this selection, See below for the override priority.

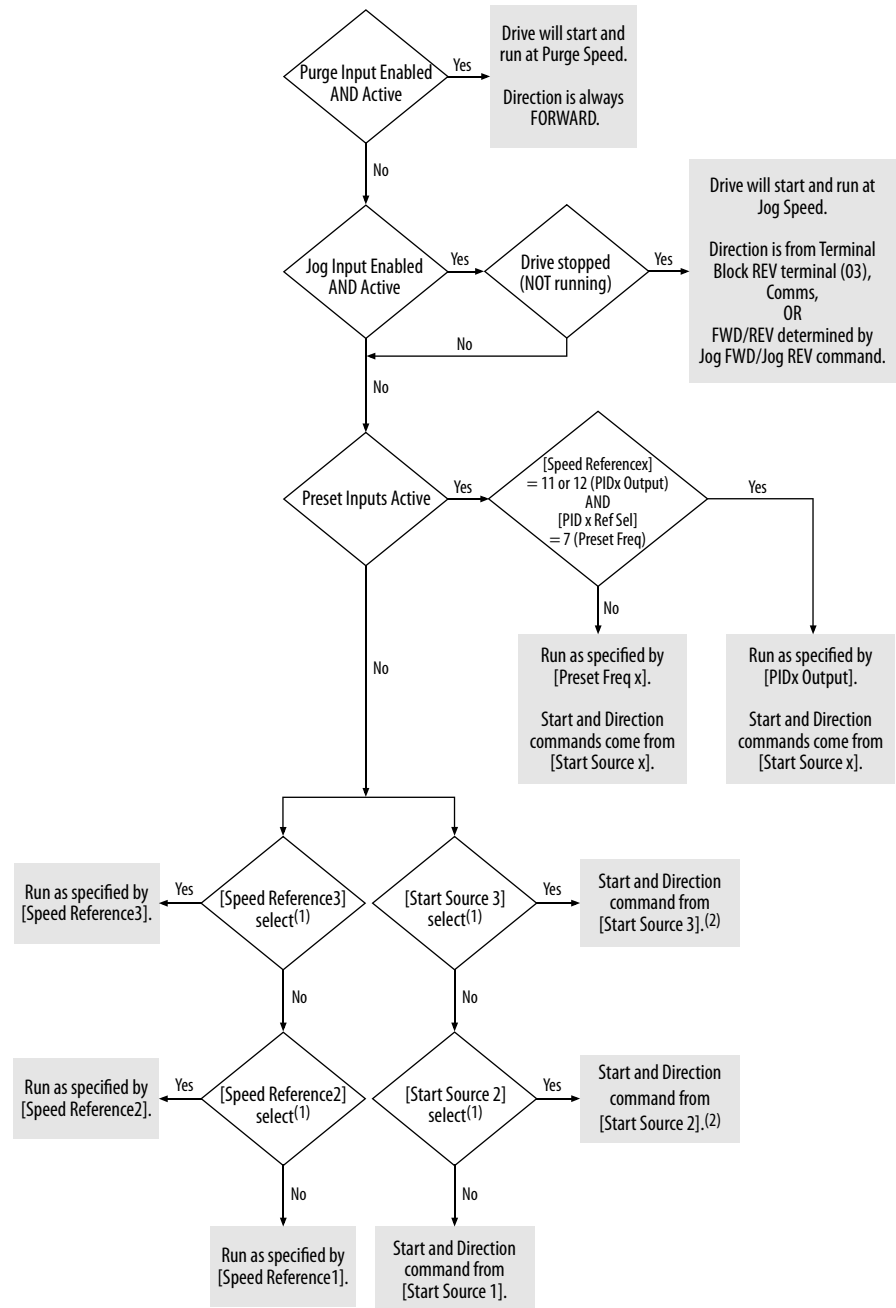

(1) [Start Source 2/3] and [Speed Reference2/3] can be selected by the control terminal block or communication commands.

(2) See [Digital Input Selection for Start Source on page 47](#) for information on selecting the correct digital input.

Digital Input Selection for Start Source

If [P046](#), [P048](#) or [P050](#) [Start Source x] has been set to 2, “DigIn TermBlk”, then [r062](#) and [r063](#) [DigIn TermBlk xx] must be configured for 2-Wire or 3-Wire control for the drive to function properly.

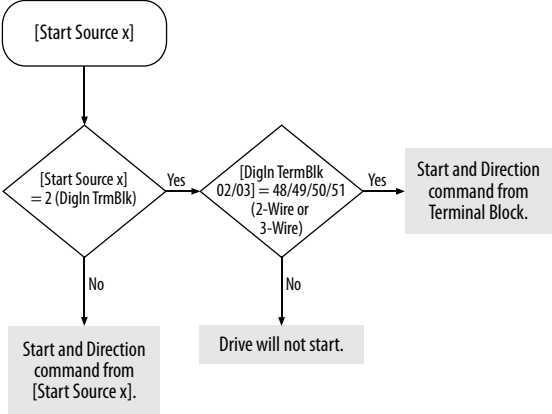

Accel/Decel Selection

The Accel/Decel rate can be obtained by a variety of methods. The default rate is determined by [P041](#) [Accel Time 1] and [P042](#) [Decel Time 1]. Alternative Accel/Decel rates can be made through digital inputs, communications and/or parameters. See below for the override priority.

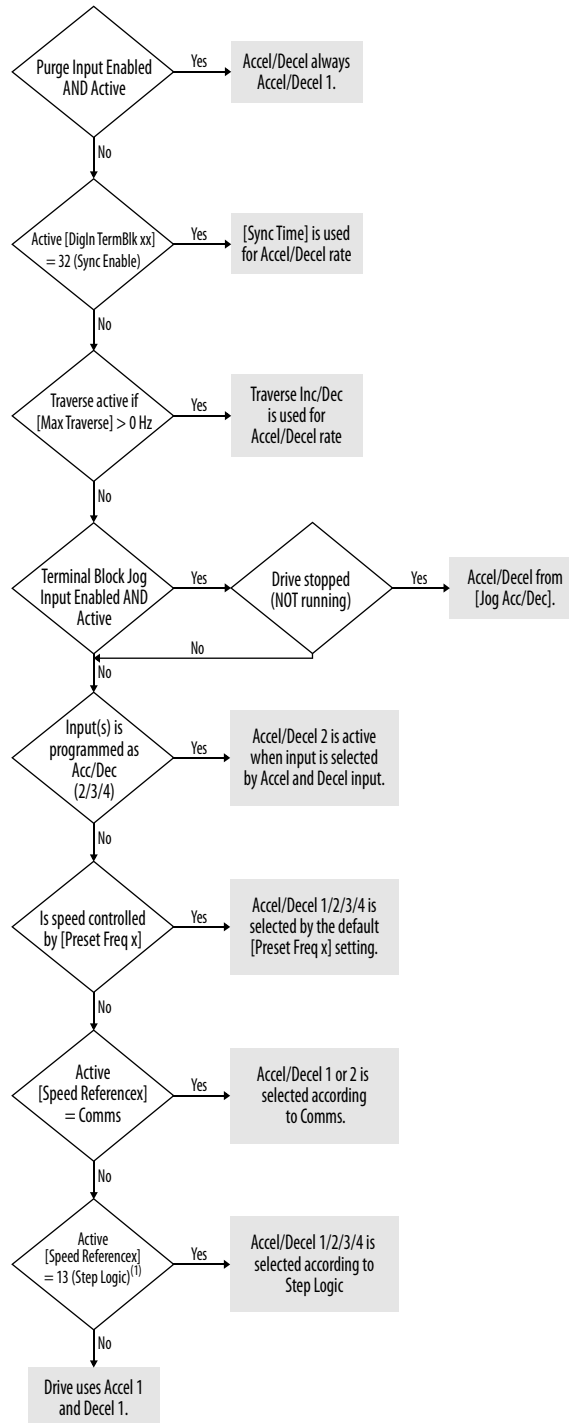

(1) Setting is specific to PowerFlex 525 drives only.

CE Conformity

Compliance with the Low Voltage Directive and Electromagnetic Compatibility Directive has been demonstrated using harmonized European Norm (EN) standards published in the Official Journal of the European Communities. PowerFlex 520-series drives comply with the EN standards listed below when installed according to the installation instructions in this manual.

CE Declarations of Conformity are available online at:

<http://www.rockwellautomation.com/products/certification/>.

Low Voltage Directive (2006/95/EC)

- EN 61800-5-1 Adjustable speed electrical power drive systems – Part 5-1: Safety requirements – Electrical, thermal and energy.

Pollution Degree Ratings According to EN 61800-5-1

Pollution Degree	Description
1	No pollution or only dry, non-conductive pollution occurs. The pollution has no influence.
2	Normally, only non-conductive pollution occurs. Occasionally, however, a temporary conductivity caused by condensation is to be expected, when the drive is out of operation.

EMC Directive (2004/108/EC)

- EN 61800-3:2004 +A1:2012 – Adjustable speed electrical power drive systems - Part 3: EMC requirements and specific test methods

Machinery Directive (2006/42/EC)

- EN ISO 13849-1:2008 – Safety of machinery – Safety related parts of control systems -Part 1: General principles for design
- EN 62061:2005 – Safety of machinery – Functional safety of safety-related electrical, electronic and programmable electronic control systems
- EN 60204-1:2006 – Safety of machinery – Electrical equipment of machines - Part 1: General requirements
- EN 61800-5-2:2007 – Adjustable speed electrical power drive systems - Part 5-2: Safety requirement – Functional

Refer to [Appendix G](#) for installation consideration related to Machinery Directive.

General Considerations

- For CE compliance, drives must satisfy installation requirements related to both EN 61800-5-1 and EN 61800-3 provided in this document.
- PowerFlex 520-series drives must be installed in a pollution degree 1 or 2 environment to be compliant with the CE LV Directive. See [Pollution Degree Ratings According to EN 61800-5-1 on page 49](#) for descriptions of each pollution degree rating.

- PowerFlex 520-series drives comply with the EMC requirements of EN 61800-3 when installed according to good EMC practices and the instructions provided in this document. However, many factors can influence the EMC compliance of an entire machine or installation, and compliance of the drive itself does not ensure compliance of all applications.
- PowerFlex 520-series drives are not intended to be used on public low-voltage networks which supply domestic premises. Without additional mitigation, radio frequency interference is expected if used on such a network. The installer is responsible for taking measures such as a supplementary line filter and enclosure (see [Connections and Grounding on page 52](#)) to prevent interference, in addition to the installation requirements of this document.



ATTENTION: NEMA/UL Open Type drives must either be installed in a supplementary enclosure or equipped with a “NEMA Type 1 Kit” to be CE compliant with respect to protection against electrical shock.

- PowerFlex 520-series drives generate harmonic current emissions on the AC supply system. When operated on a public low-voltage network it is the responsibility of the installer or user to ensure that applicable requirements of the distribution network operator have been met. Consultation with the network operator and Rockwell Automation may be necessary.
- If the optional NEMA 1 kit is not installed, the drive must be installed in an enclosure with side openings less than 12.5 mm (0.5 in.) and top openings less than 1.0 mm (0.04 in.) to maintain compliance with the LV Directive.
- The motor cable should be kept as short as possible in order to avoid electromagnetic emission as well as capacitive currents.
- Use of line filters in ungrounded systems is not recommended.
- In CE installations, input power must be a Balanced Wye with Center Ground configuration for EMC compliance.

Installation Requirements Related to EN 61800-5-1 and the Low Voltage Directive

- 600V PowerFlex 520-series drives can only be used on a “center grounded” supply system for altitudes up to and including 2000 m (6562 ft).
- When used at altitudes above 2000 m (6562 ft) up to a maximum of 4800 m (15,748 ft), PowerFlex 520-series drives of voltage classes up to 480V may not be powered from a “corner-earthed” supply system in order to maintain compliance with the CE LV Directive. See [Derating Guidelines for High Altitude on page 18](#).

- PowerFlex 520-series drives produce leakage current in the protective earthing conductor which exceeds 3.5 mA AC and/or 10 mA DC. The minimum size of the protective earthing (grounding) conductor used in the application must comply with local safety regulations for high protective earthing conductor current equipment.



ATTENTION: PowerFlex 520-series drives produce DC current in the protective earthing conductor which may reduce the ability of RCD's (residual current-operated protective devices) or RCM's (residual current-operated monitoring devices) of type A or AC to provide protection for other equipment in the installation. Where an RCD or RCM is used for protection in case of direct or indirect contact, only an RCD or RCM of Type B is allowed on the supply side of this product.

Installation Requirements Related to EN 61800-3 and the EMC Directive

- The drive must be earthed (grounded) as described in [Connections and Grounding on page 52](#). See [General Grounding Requirements on page 20](#) for additional grounding recommendations.
- Output power wiring to the motor must employ cables with a braided shield providing 75% or greater coverage, or the cables must be housed in metal conduit, or equivalent shield must be provided. Continuous shielding must be provided from the drive enclosure to the motor enclosure. Both ends of the motor cable shield (or conduit) must terminate with a low-impedance connection to earth.
Drive Frames A...E: At the drive end of the motor, either
 - a. The cable shield must be clamped to a properly installed “EMC Plate” for the drive. Kit number 25-EMC1-Fx.
or
 - b. The cable shield or conduit must terminate in a shielded connector installed in an EMC plate, conduit box, or similar.
- At the motor end, the motor cable shield or conduit must terminate in a shielded connector which must be properly installed in an earthed motor wiring box attached to the motor. The motor wiring box cover must be installed and earthed.
- All control (I/O) and signal wiring to the drive must use cable with a braided shield providing 75% or greater coverage, or the cables must be housed in metal conduit, or equivalent shielding must be provided. When shielded cable is used, the cable shield should be terminated with a low impedance connection to earth at only one end of the cable, preferably the end where the receiver is located. When the cable shield is terminated at the drive end, it may be terminated either by using a shielded connector in conjunction with a conduit plate or conduit box, or the shield may be clamped to an “EMC plate.”
- Motor cabling must be separated from control and signal wiring wherever possible.

- Maximum motor cable length must not exceed the maximum length indicated in [PowerFlex 520-Series RF Emission Compliance and Installation Requirements on page 52](#) for compliance with radio frequency emission limits for the specific standard and installation environment.

Connections and Grounding

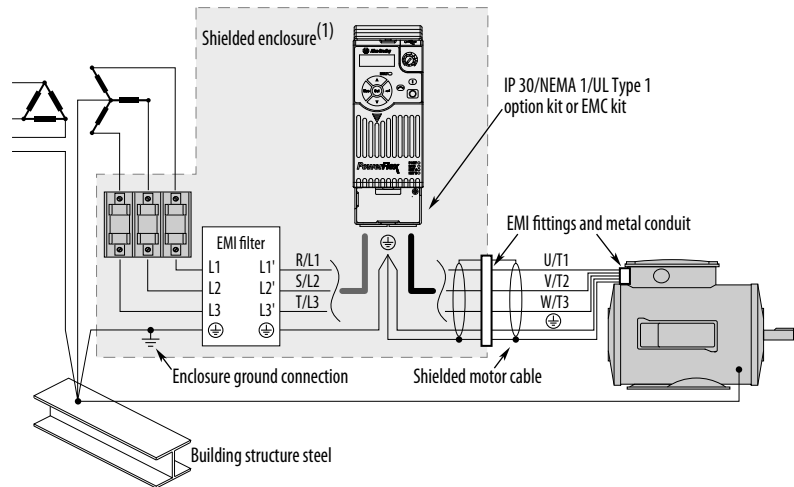

(1) Some installations require a shielded enclosure. Keep wire length as short as possible between the enclosure entry point and the EMI filter.

PowerFlex 520-Series RF Emission Compliance and Installation Requirements

Filter Type	Standard/Limits		
	EN61800-3 Category C1 EN61000-6-3 CISPR11 Group 1 Class B	EN61800-3 Category C2 EN61000-6-4 CISPR11 Group 1 Class A (Input power ≤ 20 kVA)	EN61800-3 Category C3 (I ≤ 100 A) CISPR11 Group 1 Class A (Input power > 20 kVA)
Internal	–	10 m (33 ft)	20 m (66 ft)
External ⁽¹⁾	30 m (16 ft)	100 m (328 ft)	100 m (328 ft)

(1) See [Appendix B](#) for more information on optional external filters.

Additional Installation Requirements

This section provides information on additional requirements for Class C1 and C2 installation, such as enclosures and EMC cores.

- IMPORTANT** EMC cores are included with:
- drives that have an internal EMC filter (25x-xxxxN114)
 - external EMC filter accessory kit (25-RFxxx)

IMPORTANT An enclosure, shielded input cable, and EMC cores are not required to meet class C3 requirements.

Additional Installation Requirements

Frame Size	Class C1			Class C2		
	Enclosure	Conduit or Shielded Cable @ Input	EMC Cores Required (Included with product)	Enclosure	Conduit or Shielded Cable @ Input	EMC Cores Required (Included with product)
100...120V AC (-15%, +10%) – 1-Phase Input with External EMC Filter, 0...120V 1-Phase Output						
A	No	No	No	No	No	No
B	No	No	No	No	No	No
200...240V AC (-15%, +10%) – 1-Phase Input with External EMC Filter, 0...230V 3-Phase Output						
A	Yes	Yes	No	No	No	Input/Output
B	Yes	Yes	Output only	No	No	Input/Output
200...240V AC (-15%, +10%) – 1-Phase Input with Internal EMC Filter, 0...230V 3-Phase Output⁽¹⁾						
A	*	*	*	Yes	No	No
B	*	*	*	Yes	No	No
200...240V AC (-15%, +10%) – 3-Phase Input with External EMC Filter, 0...230V 3-Phase Output						
A	Yes	Yes	Output only	No	No	Input/Output
B	Yes	Yes	Output only	No	No	Input/Output
C	Yes	Yes	Output only	No	No	Input/Output
D	Yes	Yes	No	No	No	Input only
E	Yes	Yes	Output only	No	No	Input only
380...480V AC (-15%, +10%) – 3-Phase Input with External EMC Filter, 0...460V 3-Phase Output						
A	Yes	Yes	No	No	No	Input/Output
B	Yes	Yes	No	No	No	Input/Output
C	Yes	Yes	No	No	No	Input only
D	Yes	Yes	Output only	No	No	Input/Output
E	Yes	Yes	No	Yes	No	Input/Output
380...480V AC (-15%, +10%) – 3-Phase Input with Internal EMC Filter, 0...460V 3-Phase Output⁽¹⁾						
A	*	*	*	No	No	Input/Output
B	*	*	*	No	No	Input/Output
C	*	*	*	No	No	Input/Output
D	*	*	*	No	No	Input/Output
E	*	*	*	No	No	Input/Output
525...600V AC (-15%, +10%) – 3-Phase Input with External EMC Filter, 0...575V 3-Phase Output						
A	Yes	Yes	No	No	No	Input/Output
B	Yes	Yes	No	No	No	Input/Output
C	Yes	Yes	No	No	No	Input/Output
D	Yes	Yes	No	No	No	Input/Output
E	Yes	Yes	No	Yes	No	No

(1) An (*) indicates that EMC requirements are not met.

Recommended Placement of EMC Cores

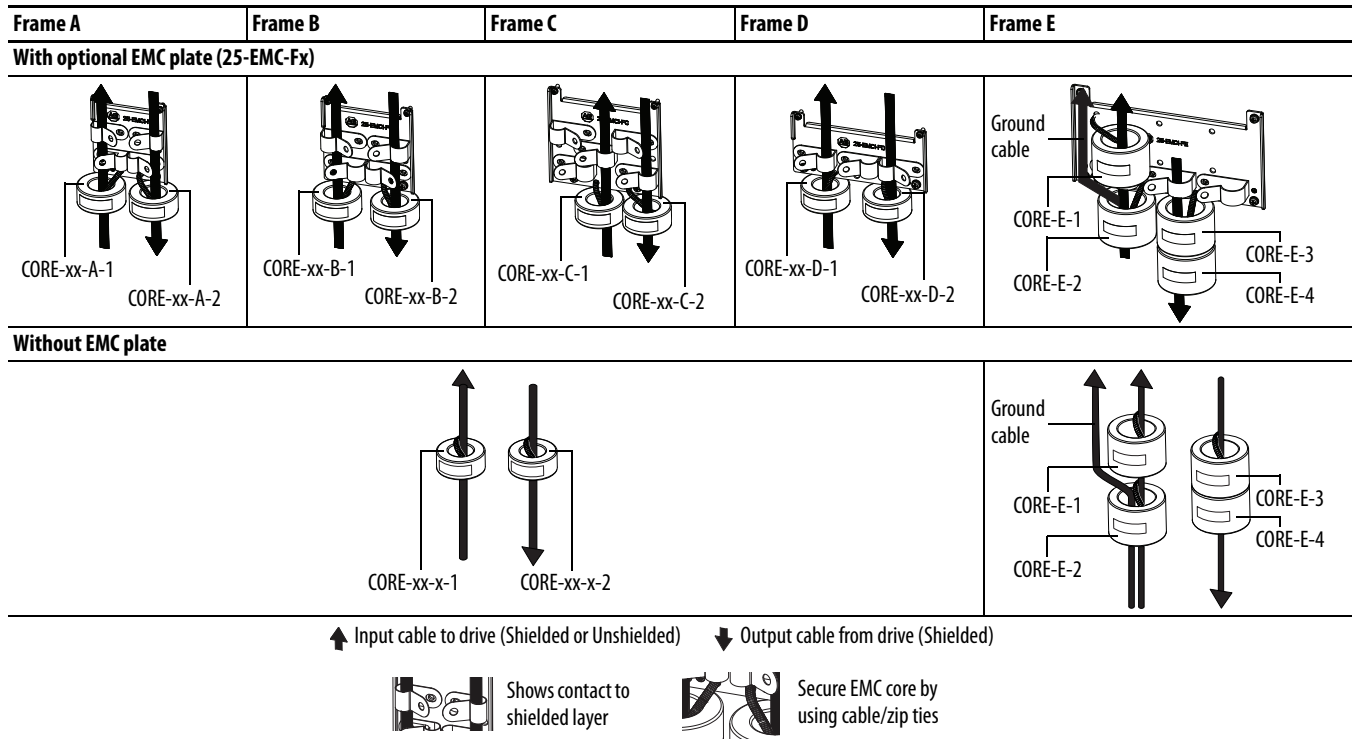

IMPORTANT

The ground cable/shield for both input and output must pass through the EMC core(s), except for the following:

- Frame E drives with internal filters where the grounded input cable must not pass through EMC CORE-E-1.
- 600V drives with external filters where the grounded output cable must not pass through the EMC core(s).

Recommended Placement of EMC Cores Relative to External Filter

All Frame sizes

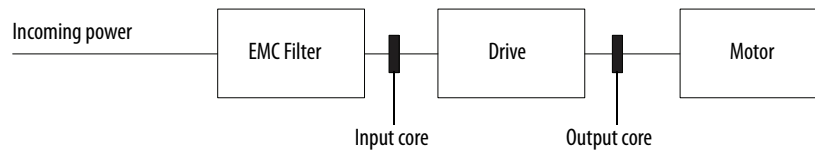

Start Up

This chapter describes how to start up the PowerFlex 520-series drive. To simplify drive setup, the most commonly programmed parameters are organized in a single Basic Program Group.

For information on...	See page...
Prepare for Drive Start-Up	55
Display and Control Keys	58
Viewing and Editing Parameters	59
Drive Programming Tools	60
Smart Start-Up with Basic Program Group Parameters	61
LCD Display with QuickView	63
Using the USB Port	63

IMPORTANT Read the *General Precautions* section before proceeding.



ATTENTION: Power must be applied to the drive to perform the following start-up procedures. Some of the voltages present are at incoming line potential. To avoid electric shock hazard or damage to equipment, only qualified service personnel should perform the following procedure. Thoroughly read and understand the procedure before beginning. If an event does not occur while performing this procedure, **Do Not Proceed. Remove All Power** including user supplied control voltages. User supplied voltages may exist even when main AC power is not applied to the drive. Correct the malfunction before continuing.

Prepare for Drive Start-Up

Drive Startup Task List

1. Disconnect and lock out power to the machine.
2. Verify that AC line power at the disconnect device is within the rated value of the drive.
3. If replacing a drive, verify the current drive's catalog number. Verify all options installed on the drive.
4. Verify that any digital control power is 24 volts.
5. Inspect grounding, wiring, connections, and environmental compatibility.

6. Verify that the Sink (SNK)/Source (SRC) jumper is set to match your control wiring scheme. See the [PowerFlex 523 Control I/O Wiring Block Diagram on page 37](#) and [PowerFlex 525 Control I/O Wiring Block Diagram on page 39](#) for location.

IMPORTANT The default control scheme is Source (SRC). The Stop terminal is jumpered to allow starting from the keypad or comms. If the control scheme is changed to Sink (SNK), the jumper must be removed from I/O Terminals 01 and 11 and installed between I/O Terminals 01 and 04.

7. Wire I/O as required for the application.
8. Wire the power input and output terminals.
9. Confirm that all inputs are connected to the correct terminals and are secure.
10. Collect and record motor nameplate and encoder or feedback device information. Verify motor connections.
 - Is the motor uncoupled?
 - What direction will the motor need to turn for the application?
11. Verify the input voltage to the drive. Verify if the drive is on a grounded system. Ensure the MOV jumpers are in the correct position. See [AC Supply Source Considerations on page 19](#) for more information.
12. Apply power and reset the drive and communication adapters to factory default settings. To reset the drive, see parameter [P053](#) [Reset to Defaults]. To reset the communication adapters, see the user manual of the adapter for more information.
13. Configure the basic program parameters related to the motor. See [Smart Start-Up with Basic Program Group Parameters on page 61](#).
14. Complete the autotune procedure for the drive. See parameter [P040](#) [Autotune] for more information.
15. If you are replacing a drive and have a backup of the parameter settings obtained using the USB utility application, use the USB utility application to apply the backup to the new drive. See [Using the USB Port on page 63](#) for more information.

Otherwise, set the necessary parameters for your application using the LCD keypad interface, Connected Components Workbench, or RSLogix or Logix Designer if using an Add-on Profile through EtherNet/IP.

- Configure the communication parameters needed for the application (node number, IP address, Datalinks in and out, communication rate, speed reference, start source, and so on). Record these settings for your reference.
- Configure the other drive parameters needed for the drive analog and digital I/O to work correctly. Verify the operation. Record these settings for your reference.

16. Verify the drive and motor perform as specified.
 - Verify that the Stop input is present or the drive will not start.

IMPORTANT If I/O Terminal 01 is used as a stop input, the jumper between I/O Terminals 01 and 11 must be removed.

- Verify the drive is receiving the speed reference from the correct place and that the reference is scaled correctly.
 - Verify the drive is receiving start and stop commands correctly.
 - Verify input currents are balanced.
 - Verify motor currents are balanced.
17. Save a backup of the drive settings using the USB utility application. See [Using the USB Port on page 63](#) for more information.

Start, Stop, Direction and Speed Control

Factory default parameter values allow the drive to be controlled from the keypad. No programming is required to start, stop, change direction and control speed directly from the keypad.

IMPORTANT To disable reverse operation, see A544 [Reverse Disable].

If a fault appears on power up, see [Fault Descriptions on page 147](#) for an explanation of the fault code.

Variable Torque Fan/Pump Applications

For improved motor tuning performance when using a premium efficient motor on a variable torque loading SVC mode, set A530 [Boost Select] to 2 “35.0, VT”.

Display and Control Keys

PowerFlex 523

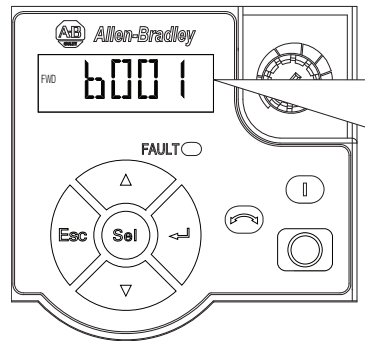

PowerFlex 525

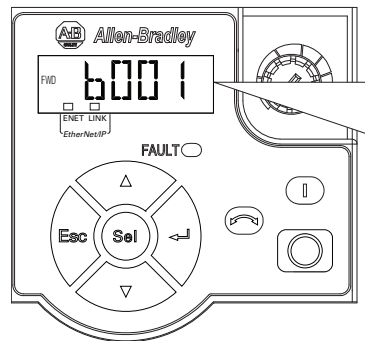









Menu	Parameter Group and Description
b	Basic Display Commonly viewed drive operating conditions.
P	Basic Program Commonly used programmable functions.
t	Terminal Blocks Programmable terminal functions.
C	Communications Programmable communication functions.
L	Logic (PowerFlex 525 only) Programmable logic functions.
d	Advanced Display Advanced drive operating conditions.
A	Advanced Program Remaining programmable functions.
N	Network Network functions that are shown only when a comm card is used.
M	Modified Functions from the other groups with values changed from default.
f	Fault and Diagnostic Consists of list of codes for specific fault conditions.
G	AppView and CustomView Functions from the other groups organized for specific applications.

Control and Navigation Keys

Display	Display State	Description
ENET (PowerFlex 525 only)	Off	Adapter is not connected to the network.
	Steady	Adapter is connected to the network and drive is controlled through Ethernet.
	Flashing	Adapter is connected to the network but drive is not controlled through Ethernet.
LINK (PowerFlex 525 only)	Off	Adapter is not connected to the network.
	Steady	Adapter is connected to the network but not transmitting data.
	Flashing	Adapter is connected to the network and transmitting data.

















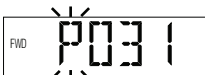
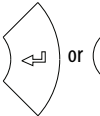



LED	LED State	Description
FAULT	Flashing Red	Indicates drive is faulted.

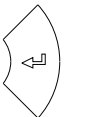

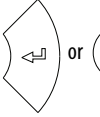





Key	Name	Description
 	Up Arrow Down Arrow	Scroll through user-selectable display parameters or groups. Increment values.
	Escape	Back one step in programming menu. Cancel a change to a parameter value and exit Program Mode.
	Select	Advance one step in programming menu. Select a digit when viewing parameter value.
	Enter	Advance one step in programming menu. Save a change to a parameter value.

Key	Name	Description
	Reverse	Used to reverse direction of the drive. Default is active. Controlled by parameters P046, P048 and P050 [Start Source x] and A544 [Reverse Disable].
	Start	Used to start the drive. Default is active. Controlled by parameters P046, P048 and P050 [Start Source x].
	Stop	Used to stop the drive or clear a fault. This key is always active. Controlled by parameter P045 [Stop Mode].
	Potentiometer	Used to control speed of drive. Default is active. Controlled by parameters P047, P049 and P051 [Speed Reference x].

Viewing and Editing Parameters

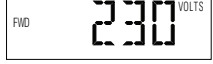
The following is an example of basic integral keypad and display functions. This example provides basic navigation instructions and illustrates how to program a parameter.

Step	Key(s)	Example Display
1. When power is applied, the last user-selected Basic Display Group parameter number is briefly displayed with flashing characters. The display then defaults to that parameter's current value. (Example shows the value of b001 [Output Freq] with the drive stopped.)		
2. Press Esc to display the Basic Display Group parameter number shown on power-up. The parameter number will flash.		
3. Press Esc to enter the parameter group list. The parameter group letter will flash.		
4. Press the Up Arrow or Down Arrow to scroll through the group list (b, P, t, C, L, d, A, f and Gx).	 or 	
5. Press Enter or Sel to enter a group. The right digit of the last viewed parameter in that group will flash.	 or 	
6. Press the Up Arrow or Down Arrow to scroll through the parameter list.	 or 	
7. Press Enter to view the value of the parameter. Or Press Esc to return to the parameter list.		
8. Press Enter or Sel to enter Program Mode and edit the value. The right digit will flash and the word Program on the LCD display will light up.	 or 	
9. Press the Up Arrow or Down Arrow to change the parameter value.	 or 	

Step	Key(s)	Example Display
10. If desired, press Sel to move from digit to digit or bit to bit. The digit or bit that you can change will flash.		
11. Press Esc to cancel a change and exit Program Mode. Or Press Enter to save a change and exit Program Mode. The digit will stop flashing and the word Program on the LCD display will turn off.	 or 	 or 
12. Press Esc to return to the parameter list. Continue to press Esc to back out of the programming menu. If pressing Esc does not change the display, then b001 [Output Freq] is displayed. Press Enter or Sel to enter the group list again.		

Drive Programming Tools

Some features in the PowerFlex 520-series drive are not supported by older configuration software tools. It is strongly recommended that customers using such tools migrate to RSLogix 5000 (version 17.0 or greater) or Logix Designer (version 21.0 or greater) with Add-On-Profile (AOP), or Connected Components Workbench (version 5.0 or greater) to enjoy a richer, full-featured configuration experience. For Automatic Device Configuration (ADC) support, RSLogix 5000 version 20.0 or greater is required.

Description	Catalog Number/Release Version
Connected Components Workbench ⁽¹⁾	Version 5.0 or greater
Logix Designer	Version 21.0 or greater
RSLogix 5000	Version 17.0 or greater
Built-in USB software tool	–
Serial Converter Module ⁽²⁾	22-SCM-232
USB Converter Module ⁽²⁾	1203-USB
Remote Panel Mount, LCD Display ⁽²⁾	22-HIM-C2S
Remote Handheld, LCD Display ⁽²⁾	22-HIM-A3

(1) Available as a free download at <http://ab.rockwellautomation.com/programmable-controllers/connected-components-workbench-software>.

(2) Does not support the new dynamic parameter groups (AppView, CustomView), and CopyCat functionality is limited to the linear parameter list.

Language Support

Language	Keypad/LCD Display	RSLogix 5000/Logix Designer	Connected Components Workbench
English	Y	Y	Y
French	Y	Y	Y
Spanish	Y	Y	Y
Italian	Y	Y	Y
German	Y	Y	Y
Japanese	–	Y	–
Portuguese	Y	Y	–
Chinese Simplified	–	Y	Y
Korean	–	Y	–

Language	Keypad/LCD Display	RSLogix 5000/ Logix Designer	Connected Components Workbench
Polish ⁽¹⁾	Y	–	–
Turkish ⁽¹⁾	Y	–	–
Czech ⁽¹⁾	Y	–	–







(1) Due to a limitation of the LCD Display, some of the characters for Polish, Turkish, and Czech will be modified.

Smart Start-Up with Basic Program Group Parameters

The PowerFlex 520-series drive is designed so that start up is simple and efficient. The Basic Program Group contains the most commonly used parameters. See [Programming and Parameters on page 65](#) for detailed descriptions of the parameters listed here, as well as the full list of available parameters.





 = Stop drive before changing this parameter.

 (PF 525) = Parameter is specific to PowerFlex 525 drives only.

No.	Parameter	Min/Max	Display/Options	Default
P030	[Language] Selects the language displayed. Important: The setting takes effect after the drive is power cycled.	1/15	1 = English 2 = Français 3 = Español 4 = Italiano 5 = Deutsch 6 = Reserved 7 = Português 8 = Reserved 9 = Reserved 10 = Reserved 11 = Reserved 12 = Polish 13 = Reserved 14 = Turkish 15 = Czech	1
P031	 [Motor NP Volts] Sets the motor nameplate rated volts.	10V (for 200V Drives), 20V (for 400V Drives), 25V (for 600V Drives)/Drive Rated Volts	1V	Based on Drive Rating
P032	 [Motor NP Hertz] Sets the motor nameplate rated frequency.	15/500 Hz	1 Hz	60 Hz
P033	[Motor OL Current] Sets the motor nameplate overload current.	0.0/(Drive Rated Amps x 2)	0.1 A	Based on Drive Rating
P034	[Motor NP FLA] Sets the motor nameplate FLA.	0.0/(Drive Rated Amps x 2)	0.1 A	Drive Rated Amps
P035	[Motor NP Poles] Sets the number of poles in the motor.	2/40	1	4
P036	 [Motor NP RPM] Sets the rated nameplate rpm of motor.	0/24000 rpm	1 rpm	1750 rpm
P037	 (PF 525) [Motor NP Power] Sets the motor nameplate power. Used in PM regulator.	0.00/Drive Rated Power	0.01 kW	Drive Rated Power
P038	 [Voltage Class] Sets the voltage class of 600V drives. Only applicable to 600V drives.	2/3	2 = "480V" 3 = "600V"	3
P039	 [Torque Perf Mode] Selects the motor control mode. (1) Setting is specific to PowerFlex 525 drives only.	0/3	0 = "V/Hz" 1 = "SVC" 2 = "Economize" 3 = "Vector" ⁽¹⁾	1

 = Stop drive before changing this parameter.

 ^(PF 525) = Parameter is specific to PowerFlex 525 drives only.

No.	Parameter	Min/Max	Display/Options	Default
P040	[Autotune]	0/2	0 = "Ready/Idle" 1 = "Static Tune" 2 = "Rotate Tune"	0
	Enables a static (not spinning) or dynamic (motor spinning) autotune.			
P041	[Accel Time 1]	0.00/600.00 s	0.01 s	10.00 s
	Sets the time for the drive to accel from 0 Hz to [Maximum Freq].			
P042	[Decel Time 1]	0.00/600.00 s	0.01 s	10.00 s
	Sets the time for the drive to decel from [Maximum Freq] to 0 Hz.			
P043	[Minimum Freq]	0.00/500.00 Hz	0.01 Hz	0.00 Hz
	Sets the lowest frequency the drive outputs.			
P044	[Maximum Freq]	0.00/500.00 Hz	0.01 Hz	60.00 Hz
	Sets the highest frequency the drive outputs.			
P045	[Stop Mode]	0/11	0 = "Ramp, CF ⁽¹⁾ " 1 = "Coast, CF ⁽¹⁾ " 2 = "DC Brake, CF ⁽¹⁾ " 3 = "DCBrkAuto, CF ⁽¹⁾ " 4 = "Ramp" 5 = "Coast" 6 = "DC Brake" 7 = "DC BrakeAuto" 8 = "Ramp+EM B, CF ⁽¹⁾ " 9 = "Ramp+EM Brk" 10 = "PointStp, CF ⁽¹⁾ " 11 = "PointStop"	0
	Stop command for normal stop. Important: I/O Terminal 01 is always a stop input. The stopping mode is determined by the drive setting. Important: The drive is shipped with a jumper installed between I/O Terminals 01 and 11. Remove this jumper when using I/O Terminal 01 as a stop or enable input. (1) Stop input also clears active fault.			
P046, P048, P050	[Start Source 1]	1/5	1 = "Keypad ⁽¹⁾ " 2 = "DigIn TrmBlk" ⁽²⁾ 3 = "Serial/DSI" 4 = "Network Opt" 5 = "Ethernet/IP" ⁽³⁾	P046 = 1 P048 = 2 P050 = 3 (PowerFlex 523) 5 (PowerFlex 525)
	Sets the default control scheme used to start the drive unless overridden by P048 [Start Source 2] or P050 [Start Source 3]. (1) When active, the Reverse key is also active unless disabled by A544 [Reverse Disable]. (2) If "DigIn TrmBlk" is selected, ensure that the digital inputs are properly configured. (3) Setting is specific to PowerFlex 525 drives only.			
P047, P049, P051	[Speed Reference 1]	1/16	1 = "Drive Pot" 2 = "Keypad Freq" 3 = "Serial/DSI" 4 = "Network Opt" 5 = "0-10V Input" 6 = "4-20mA Input" 7 = "Preset Freq" 8 = "Anlg In Mult" ⁽¹⁾ 9 = "MOP" 10 = "Pulse Input" 11 = "PID1 Output" 12 = "PID2 Output" ⁽¹⁾ 13 = "Step Logic" ⁽¹⁾ 14 = "Encoder" ⁽¹⁾ 15 = "Ethernet/IP" ⁽¹⁾ 16 = "Positioning" ⁽¹⁾	P047 = 1 P049 = 5 P051 = 3 (PowerFlex 523) 15 (PowerFlex 525)
	Sets the default speed command of the drive unless overridden by P049 [Speed Reference2] or P051 [Speed Reference3]. (1) Setting is specific to PowerFlex 525 drives only.			
P052	[Average kWh Cost]	0.00/655.35	0.01	0.00
	Sets the average cost per kWh.			
P053	[Reset To Defaults]	0/3	0 = "Ready/Idle" 1 = "Param Reset" 2 = "Factory Rset" 3 = "Power Reset"	0
	Resets parameters to their factory defaults values. After a Reset command, the value of this parameter returns to zero.			

LCD Display with QuickView

QuickView™ enables text to scroll across the LCD display of the PowerFlex 520-series drive. This allows you to easily configure parameters, troubleshoot faults and view diagnostic items without using a separate device.

Use parameter [A556](#) [Text Scroll] to set the speed at which the text scrolls across the display. Select 0 “Off” to turn off text scrolling. See [Language Support on page 60](#) for the languages supported by the PowerFlex 520-series drive.

Using the USB Port

The PowerFlex 520-series drive has a USB port that connects to a PC for the purpose of upgrading drive firmware or uploading/downloading a parameter configuration.

IMPORTANT To use the USB feature of the PowerFlex 520-series drive, Microsoft .Net Framework 2.0 and Windows XP or later is required.

MainsFree Programming

The MainsFree™ programming feature allows you to quickly configure your PowerFlex 520-series drive without having to power up the control module or install additional software. Simply connect the control module to your PC with a USB Type B cable and you can download a parameter configuration to your drive. You can also easily upgrade your drive with the latest firmware.

Connecting a PowerFlex 520-series drive to a PC

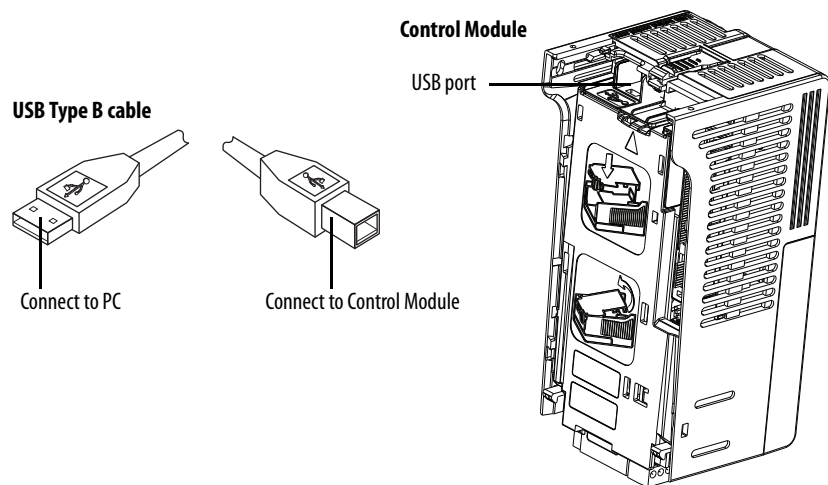

When connected, the drive appears on the PC and contains two files:

- **GUIDE.PDF**
This file contains links to relevant product documentation and software downloads.
-  **PF52XUSB.EXE**
This file is an application to flash upgrade firmware or upload/download a parameter configuration.

It is not possible to delete these files or add more to the drive.

Double-click on the PF52XUSB.EXE file to launch the USB utility application. The main menu is displayed. Follow the program instructions to upgrade the firmware or upload/download configuration data.

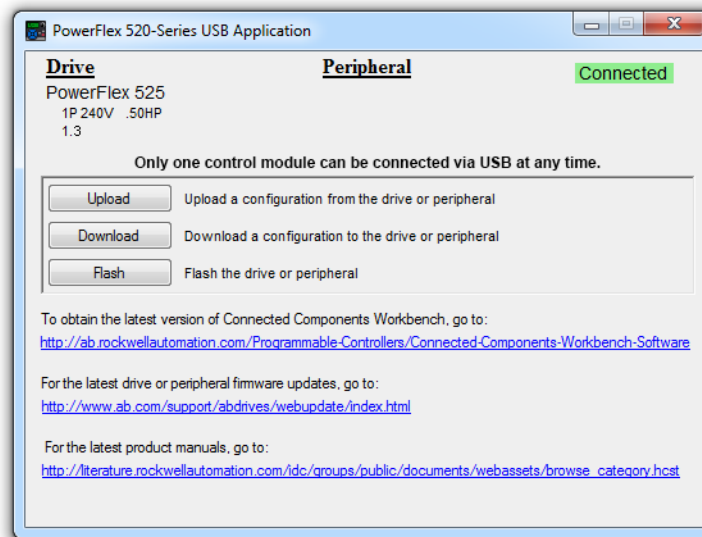

IMPORTANT Make sure your PC is powered by an AC power outlet or has a fully charged battery before starting any operation. This prevents the operation from terminating before completion due to insufficient power.

Limitation in Downloading .pf5 Configuration Files with the USB Utility Application

Before downloading a .pf5 configuration file using the USB utility application, parameter C169 [MultiDrv Sel] in the destination drive must match the incoming configuration file. If it does not, set the parameter manually to match and then cycle drive power.

This means you cannot apply a multi-drive configuration using the USB utility application to a drive in single mode (parameter C169 [MultiDrv Sel] set to 0 “Disabled”), or apply a single mode configuration to a drive in multi-drive mode.

Programming and Parameters

This chapter provides a complete listing and description of the PowerFlex 520-series drive parameters. Parameters are programmed (viewed/edited) using either the drive's built-in keypad, RSLogix 5000 version 17.0 or greater, Logix Designer version 21.0 or greater, or Connected Components Workbench version 5.0 or greater software. The Connected Components Workbench software can be used offline (through USB) to upload parameter configurations to the drive or online (through Ethernet connection).

Limited functionality is also available when using the Connected Components Workbench software online (through DSI and serial converter module), a legacy external HIM, or legacy software online (DriveTools SP™). When using these methods, the parameter list can only be displayed linearly, and there is no access to communications option card programming.

For information on...	See page...
About Parameters	65
Parameter Groups	66
Basic Display Group	71
Basic Program Group	76
Terminal Block Group	82
Communications Group	94
Logic Group	100
Advanced Display Group	103
Advanced Program Group	107
Network Parameter Group	130
Modified Parameter Group	130
Fault and Diagnostic Group	130
AppView Parameter Groups	138
CustomView Parameter Group	139
Parameter Cross Reference by Name	140

About Parameters

To configure a drive to operate in a specific way, drive parameters may have to be set. Three types of parameters exist:

- **ENUM**
ENUM parameters allow a selection from 2 or more items. Each item is represented by a number.
- **Numeric Parameters**
These parameters have a single numerical value (0.1V).

• **Bit Parameters**

Bit parameters have five individual digits associated with features or conditions. If the digit is 0, the feature is off or the condition is false. If the digit is 1, the feature is on or the condition is true.

Some parameters are marked as follows.



= Stop drive before changing this parameter.



= 32 bit parameter. Parameters marked 32 bit will have two parameter numbers ([Step Units x]) and [Step Units F x]) when using RS485 communications and programming software. The second parameter number is shown only in the Parameter Groups and Parameter Cross Reference by Name tables for reference.



PF 525 = Parameter is specific to PowerFlex 525 drives only.

Parameter Groups

For an alphabetical listing of parameters, see [Parameter Cross Reference by Name on page 140](#).

Basic Display		Output Voltage	b004	Control Source	b012	Elapsed Run Time	b019	Accum CO2 Sav	b026
		DC Bus Voltage	b005	Contrl In Status	b013	Average Power	b020	Drive Temp	b027
		Drive Status	b006	Dig In Status	b014	Elapsed kWh	b021	Control Temp	b028
		Fault 1 Code	b007	Output RPM	b015	Elapsed MWh	b022	Control SW Ver	b029
Output Freq	b001	Fault 2 Code	b008	Output Speed	b016	Energy Saved	b023		
Commanded Freq	b002	Fault 3 Code	b009	Output Power	b017	Accum kWh Sav	b024		
Output Current	b003	Process Display	b010	Power Saved	b018	Accum Cost Sav	b025		
Basic Program		Motor NP Hertz	P032	Voltage Class	P038	Maximum Freq	P044	Start Source 3	P050
		Motor OL Current	P033	Torque Perf Mode	P039	Stop Mode	P045	Speed Reference3	P051
		Motor NP FLA	P034	Autotune	P040	Start Source 1	P046	Average kWh Cost	P052
		Motor NP Poles	P035	Accel Time 1	P041	Speed Reference1	P047	Reset To Defaults	P053
Language	P030	Motor NP RPM	P036	Decel Time 1	P042	Start Source 2	P048		
Motor NP Volts	P031	Motor NP Power	P037	Minimum Freq	P043	Speed Reference2	P049		
Terminal Blocks		DigIn TermBlk 07 ⁽¹⁾	t067	Relay 1 On Time	t079	Analog Out High ⁽¹⁾	t089	Anlg Loss Delay	t098
		DigIn TermBlk 08 ⁽¹⁾	t068	Relay 1 Off Time	t080	Anlg Out Setpt ⁽¹⁾	t090	Analog In Filter	t099
		Opto Out1 Sel ⁽¹⁾	t069	Relay Out2 Sel ⁽¹⁾	t081	Anlg In 0-10V Lo	t091	Sleep-Wake Sel	t100
		Opto Out1 Level ⁽¹⁾	t070	Relay Out2 Level ⁽¹⁾	t082	Anlg In 0-10V Hi	t092	Sleep Level	t101
DigIn TermBlk 02	t062	Opto Out2 Sel ⁽¹⁾	t072	Relay 2 On Time ⁽¹⁾	t084	10V Bipolar Enbl ⁽¹⁾	t093	Sleep Time	t102
DigIn TermBlk 03	t063	Opto Out2 Level ⁽¹⁾	t073	Relay 2 Off Time ⁽¹⁾	t085	Anlg In V Loss	t094	Wake Level	t103
2-Wire Mode	t064	Opto Out Logic ⁽¹⁾	t075	EM Brk Off Delay	t086	Anlg In4-20mA Lo	t095	Wake Time	t104
DigIn TermBlk 05	t065	Relay Out1 Sel	t076	EM Brk On Delay	t087	Anlg In4-20mA Hi	t096	Safety Open En ⁽¹⁾	t105
DigIn TermBlk 06	t066	Relay Out1 Level	t077	Analog Out Sel ⁽¹⁾	t088	Anlg In mA Loss	t097		
Communications		EN Addr Sel ⁽¹⁾	C128	EN Gateway Cfg 3 ⁽¹⁾	C139	EN Data In 1 ⁽¹⁾	C153	Opt Data In 4	C164
		EN IP Addr Cfg 1 ⁽¹⁾	C129	EN Gateway Cfg 4 ⁽¹⁾	C140	EN Data In 2 ⁽¹⁾	C154	Opt Data Out 1	C165
		EN IP Addr Cfg 2 ⁽¹⁾	C130	EN Rate Cfg ⁽¹⁾	C141	EN Data In 3 ⁽¹⁾	C155	Opt Data Out 2	C166
		EN IP Addr Cfg 3 ⁽¹⁾	C131	EN Comm Flt Actn ⁽¹⁾	C143	EN Data In 4 ⁽¹⁾	C156	Opt Data Out 3	C167
Comm Write Mode	C121	EN IP Addr Cfg 4 ⁽¹⁾	C132	EN Idle Flt Actn ⁽¹⁾	C144	EN Data Out 1 ⁽¹⁾	C157	Opt Data Out 4	C168
Cmd Stat Select ⁽¹⁾	C122	EN Subnet Cfg 1 ⁽¹⁾	C133	EN Flt Cfg Logic ⁽¹⁾	C145	EN Data Out 2 ⁽¹⁾	C158	MultiDrv Sel	C169
RS485 Data Rate	C123	EN Subnet Cfg 2 ⁽¹⁾	C134	EN Flt Cfg Ref ⁽¹⁾	C146	EN Data Out 3 ⁽¹⁾	C159	Drv 1 Addr	C171
RS485 Node Addr	C124	EN Subnet Cfg 3 ⁽¹⁾	C135	EN Flt Cfg DL 1 ⁽¹⁾	C147	EN Data Out 4 ⁽¹⁾	C160	Drv 2 Addr	C172
Comm Loss Action	C125	EN Subnet Cfg 4 ⁽¹⁾	C136	EN Flt Cfg DL 2 ⁽¹⁾	C148	Opt Data In 1	C161	Drv 3 Addr	C173
Comm Loss Time	C126	EN Gateway Cfg 1 ⁽¹⁾	C137	EN Flt Cfg DL 3 ⁽¹⁾	C149	Opt Data In 2	C162	Drv 4 Addr	C174
RS485 Format	C127	EN Gateway Cfg 2 ⁽¹⁾	C138	EN Flt Cfg DL 4 ⁽¹⁾	C150	Opt Data In 3	C163	DSI I/O Cfg	C175

(1) Parameter is specific to PowerFlex 525 drives only.

Logic⁽¹⁾ 	Stp Logic 2	L182	Stp Logic Time 0	L190	Stp Logic Time 6	L196	Step Units 4	L208	
	Stp Logic 3	L183	Stp Logic Time 1	L191	Stp Logic Time 7	L197	Step Units 5	L210	
	Stp Logic 4	L184	Stp Logic Time 2	L192	Step Units 0	L200	Step Units 6	L212	
	Stp Logic 5	L185	Stp Logic Time 3	L193	Step Units 1	L202	Step Units 7	L214	
	Stp Logic 6	L186	Stp Logic Time 4	L194	Step Units 2	L204			
	Stp Logic 7	L187	Stp Logic Time 5	L195	Step Units 3	L206			
	Stp Logic 0	L180							
Advanced Display									
	Elapsed Time-hr	d362	Motor OL Level	d369	Torque Current	d382	Units Traveled H ⁽¹⁾	d388	
	Elapsed Time-min	d363	Slip Hz Meter	d375	PID1 Fdbk Displ	d383	Units Traveled L ⁽¹⁾	d389	
	Counter Status	d364	Speed Feedback	d376	PID1 Setpnt Disp	d384	Fiber Status	d390	
	Timer Status	d365	Encoder Speed ⁽¹⁾	d378	PID2 Fdbk Displ	d385	Stp Logic Status ⁽¹⁾	d391	
Analog In 0-10V	d360	Drive Type	d367	DC Bus Ripple	d380	PID2 Setpnt Disp	d386	RdyBit Mode Act ⁽¹⁾	
Analog In 4-20mA	d361	Testpoint Data	d368	Output Powr Fctr	d381	Position Status	d387		
Advanced Program									
	DB Resistor Sel	A437	PID 2 Trim Hi ⁽¹⁾	A468	Motor Lx ⁽¹⁾	A500	Compensation	A547	
	DB Threshold	A438	PID 2 Trim Lo ⁽¹⁾	A469	Speed Reg Sel	A509	Power Loss Mode	A548	
	S Curve %	A439	PID 2 Trim Sel ⁽¹⁾	A470	Freq 1	A510	Half Bus Enable	A549	
	PWM Frequency	A440	PID 2 Ref Sel ⁽¹⁾	A471	Freq 1 BW	A511	Bus Reg Enable	A550	
	Preset Freq 0	A410	Droop Hertz@ FLA ⁽¹⁾	A441	PID 2 Fdbk Sel ⁽¹⁾	A472	Freq 2	A512	Fault Clear
	Preset Freq 1	A411	Accel Time 2	A442	PID 2 Prop Gain ⁽¹⁾	A473	Freq 2 BW	A513	Program Lock
	Preset Freq 2	A412	Decel Time 2	A443	PID 2 Integ Time ⁽¹⁾	A474	Freq 3	A514	Program Lock Mod
	Preset Freq 3	A413	Accel Time 3	A444	PID 2 Diff Rate ⁽¹⁾	A475	Freq 3 BW	A515	Drv Ambient Sel
	Preset Freq 4	A414	Decel Time 3	A445	PID 2 Setpoint ⁽¹⁾	A476	Freq 1 Kp	A521	Reset Meters
	Preset Freq 5	A415	Accel Time 4	A446	PID 2 Deadband ⁽¹⁾	A477	Freq 1 Ki	A522	Text Scroll
	Preset Freq 6	A416	Decel Time 4	A447	PID 2 Preload ⁽¹⁾	A478	Freq 2 Kp	A523	Out Phas Loss En
	Preset Freq 7	A417	Skip Frequency 1	A448	PID 2 Invert Err ⁽¹⁾	A479	Freq 2 Ki	A524	Positioning Mode ⁽¹⁾
	Preset Freq 8 ⁽¹⁾	A418	Skip Freq Band 1	A449	Process Disp Lo	A481	Freq 3 Kp	A525	Counts Per Unit ⁽¹⁾
	Preset Freq 9 ⁽¹⁾	A419	Skip Frequency 2	A450	Process Disp Hi	A482	Freq 3 Ki	A526	Enh Control Word ⁽¹⁾
	Preset Freq 10 ⁽¹⁾	A420	Skip Freq Band 2	A451	Testpoint Sel	A483	Boost Select	A530	Home Save ⁽¹⁾
	Preset Freq 11 ⁽¹⁾	A421	Skip Frequency 3 ⁽¹⁾	A452	Current Limit 1	A484	Start Boost	A531	Find Home Freq ⁽¹⁾
	Preset Freq 12 ⁽¹⁾	A422	Skip Freq Band 3 ⁽¹⁾	A453	Current Limit 2 ⁽¹⁾	A485	Break Voltage	A532	Find Home Dir ⁽¹⁾
	Preset Freq 13 ⁽¹⁾	A423	Skip Frequency 4 ⁽¹⁾	A454	Shear Pin 1 Level	A486	Break Frequency	A533	Encoder Pos Tol ⁽¹⁾
	Preset Freq 14 ⁽¹⁾	A424	Skip Freq Band 4 ⁽¹⁾	A455	Shear Pin 1 Time	A487	Maximum Voltage	A534	Pos Reg Filter ⁽¹⁾
	Preset Freq 15 ⁽¹⁾	A425	PID 1 Trim Hi	A456	Shear Pin2 Level ⁽¹⁾	A488	Motor Fdbk Type ⁽¹⁾	A535	Pos Reg Gain ⁽¹⁾
	Keypad Freq	A426	PID 1 Trim Lo	A457	Shear Pin 2 Time ⁽¹⁾	A489	Encoder PPR ⁽¹⁾	A536	Max Traverse
	MOP Freq	A427	PID 1 Trim Sel	A458	Load Loss Level ⁽¹⁾	A490	Pulse In Scale	A537	Traverse Inc
	MOP Reset Sel	A428	PID 1 Ref Sel	A459	Load Loss Time ⁽¹⁾	A491	Ki Speed Loop ⁽¹⁾	A538	Traverse Dec
	MOP Preload	A429	PID 1 Fdbk Sel	A460	Stall Fault Time	A492	Kp Speed Loop ⁽¹⁾	A539	P Jump
	MOP Time	A430	PID 1 Prop Gain	A461	Motor OL Select	A493	Var PWM Disable	A540	Sync Time
	Jog Frequency	A431	PID 1 Integ Time	A462	Motor OL Ret	A494	Auto Rstrt Tries	A541	Speed Ratio
	Jog Accel/Decel	A432	PID 1 Diff Rate	A463	Drive OL Mode	A495	Auto Rstrt Delay	A542	Mtr Options Cfg
	Purge Frequency	A433	PID 1 Setpoint	A464	IR Voltage Drop	A496	Start At PowerUp	A543	RdyBit Mode Cfg ⁽¹⁾
	DC Brake Time	A434	PID 1 Deadband	A465	Flux Current Ref	A497	Reverse Disable	A544	
	DC Brake Level	A435	PID 1 Preload	A466	Motor Rr ⁽¹⁾	A498	Flying Start En	A545	
DC Brk Time@Strt	A436	PID 1 Invert Err	A467	Motor Lm ⁽¹⁾	A499	FlyStrt CurLimit	A546		

Network



This group contains parameters for the network option card that is installed. See the network option card's user manual for more information on the available parameters.

Modified



This group contains parameters that have their values changed from the factory default. When a parameter has its default value changed, it is automatically added to this group. When a parameter has its value changed back to the factory default, it is automatically removed from this group.

(1) Parameter is specific to PowerFlex 525 drives only.

Fault and Diagnostic		Fault 5 Time-min	F625 Fault10 Current ⁽¹⁾	F650 EN Rate Act ⁽¹⁾	F685 Drv 1 Reference	F710
		Fault 6 Time-min ⁽¹⁾	F626 Fault 1 BusVolts	F651 DSI I/O Act	F686 Drv 1 Logic Sts	F711
		Fault 7 Time-min ⁽¹⁾	F627 Fault 2 BusVolts	F652 HW Addr 1 ⁽¹⁾	F687 Drv 1 Feedback	F712
		Fault 8 Time-min ⁽¹⁾	F628 Fault 3 BusVolts	F653 HW Addr 2 ⁽¹⁾	F688 Drv 2 Logic Cmd	F713
Fault 4 Code	F604	Fault 9 Time-min ⁽¹⁾	F629 Fault 4 BusVolts	F654 HW Addr 3 ⁽¹⁾	F689 Drv 2 Reference	F714
Fault 5 Code	F605	Fault10 Time-min ⁽¹⁾	F630 Fault 5 BusVolts	F655 HW Addr 4 ⁽¹⁾	F690 Drv 2 Logic Sts	F715
Fault 6 Code	F606	Fault 1 Freq	F631 Fault 6 BusVolts ⁽¹⁾	F656 HW Addr 5 ⁽¹⁾	F691 Drv 2 Feedback	F716
Fault 7 Code	F607	Fault 2 Freq	F632 Fault 7 BusVolts ⁽¹⁾	F657 HW Addr 6 ⁽¹⁾	F692 Drv 3 Logic Cmd	F717
Fault 8 Code	F608	Fault 3 Freq	F633 Fault 8 BusVolts ⁽¹⁾	F658 EN IP Addr Act 1 ⁽¹⁾	F693 Drv 3 Reference	F718
Fault 9 Code	F609	Fault 4 Freq	F634 Fault 9 BusVolts ⁽¹⁾	F659 EN IP Addr Act 2 ⁽¹⁾	F694 Drv 3 Logic Sts	F719
Fault10 Code	F610	Fault 5 Freq	F635 Fault10 BusVolts ⁽¹⁾	F660 EN IP Addr Act 3 ⁽¹⁾	F695 Drv 3 Feedback	F720
Fault 1 Time-hr	F611	Fault 6 Freq ⁽¹⁾	F636 Status @ Fault 1	F661 EN IP Addr Act 4 ⁽¹⁾	F696 Drv 4 Logic Cmd	F721
Fault 2 Time-hr	F612	Fault 7 Freq ⁽¹⁾	F637 Status @ Fault 2	F662 EN Subnet Act 1 ⁽¹⁾	F697 Drv 4 Reference	F722
Fault 3 Time-hr	F613	Fault 8 Freq ⁽¹⁾	F638 Status @ Fault 3	F663 EN Subnet Act 2 ⁽¹⁾	F698 Drv 4 Logic Sts	F723
Fault 4 Time-hr	F614	Fault 9 Freq ⁽¹⁾	F639 Status @ Fault 4	F664 EN Subnet Act 3 ⁽¹⁾	F699 Drv 4 Feedback	F724
Fault 5 Time-hr	F615	Fault10 Freq ⁽¹⁾	F640 Status @ Fault 5	F665 EN Subnet Act 4 ⁽¹⁾	F700 EN Rx Overruns ⁽¹⁾	F725
Fault 6 Time-hr ⁽¹⁾	F616	Fault 1 Current	F641 Status @ Fault 6 ⁽¹⁾	F666 EN Gateway Act 1 ⁽¹⁾	F701 EN Rx Packets ⁽¹⁾	F726
Fault 7 Time-hr ⁽¹⁾	F617	Fault 2 Current	F642 Status @ Fault 7 ⁽¹⁾	F667 EN Gateway Act 2 ⁽¹⁾	F702 EN Rx Errors ⁽¹⁾	F727
Fault 8 Time-hr ⁽¹⁾	F618	Fault 3 Current	F643 Status @ Fault 8 ⁽¹⁾	F668 EN Gateway Act 3 ⁽¹⁾	F703 EN Tx Packets ⁽¹⁾	F728
Fault 9 Time-hr ⁽¹⁾	F619	Fault 4 Current	F644 Status @ Fault 9 ⁽¹⁾	F669 EN Gateway Act 4 ⁽¹⁾	F704 EN Tx Errors ⁽¹⁾	F729
Fault10 Time-hr ⁽¹⁾	F620	Fault 5 Current	F645 Status @ Fault10 ⁽¹⁾	F670 Drv 0 Logic Cmd	F705 EN Missed IO Pkt ⁽¹⁾	F730
Fault 1 Time-min	F621	Fault 6 Current ⁽¹⁾	F646 Comm Sts - DSI	F681 Drv 0 Reference	F706 DSI Errors	F731
Fault 2 Time-min	F622	Fault 7 Current ⁽¹⁾	F647 Comm Sts - Opt	F682 Drv 0 Logic Sts	F707	
Fault 3 Time-min	F623	Fault 8 Current ⁽¹⁾	F648 Com Sts-Emb Enet ⁽¹⁾	F683 Drv 0 Feedback	F708	
Fault 4 Time-min	F624	Fault 9 Current ⁽¹⁾	F649 EN Addr Src ⁽¹⁾	F684 Drv 1 Logic Cmd	F709	

(1) Parameter is specific to PowerFlex 525 drives only.

AppView Parameter Groups

PowerFlex 520-series drives include various AppView™ parameter groups that groups certain parameters together for quick and easy access based on different types of applications. See [AppView Parameter Groups on page 138](#) for more information.

Conveyor 	Motor NP Volts	P031	Decel Time 1	P042	DigIn TermBlk 03	t063	Anlg In mA Loss	t097	
	Motor NP Hertz	P032	Minimum Freq	P043	Opto Out1 Sel	t069	Slip Hz Meter	d375	
	Motor OL Current	P033	Maximum Freq	P044	Relay Out1 Sel	t076	Preset Freq 0	A410	
	Motor NP FLA	P034	Stop Mode	P045	Anlg In 0-10V Lo	t091	Jog Frequency	A431	
	Language	P030	Motor NP Poles	P035	Start Source 1	P046	Anlg In 0-10V Hi	t092	Jog Accel/Decel
Output Freq	b001	Autotune	P040	Speed Reference1	P047	Anlg In4-20mA Lo	t095	S Curve %	A439
Commanded Freq	b002	Accel Time 1	P041	DigIn TermBlk 02	t062	Anlg In4-20mA Hi	t096	Reverse Disable	A544
Mixer 	Commanded Freq	b002	Motor NP Poles	P035	Stop Mode	P045	Anlg In4-20mA Lo	t095	
	Output Current	b003	Autotune	P040	Start Source 1	P046	Anlg In4-20mA Hi	t096	
	Motor NP Volts	P031	Accel Time 1	P041	Speed Reference1	P047	Anlg In mA Loss	t097	
	Motor NP Hertz	P032	Decel Time 1	P042	Relay Out1 Sel	t076	Preset Freq 0	A410	
	Language	P030	Motor OL Current	P033	Minimum Freq	P043	Anlg In 0-10V Lo	t091	Stall Fault Time
Output Freq	b001	Motor NP FLA	P034	Maximum Freq	P044	Anlg In 0-10V Hi	t092		
Compressor 	Motor NP Hertz	P032	Maximum Freq	P044	Anlg In 0-10V Lo	t091	Start At PowerUp	A543	
	Motor OL Current	P033	Stop Mode	P045	Anlg In 0-10V Hi	t092	Reverse Disable	A544	
	Motor NP FLA	P034	Start Source 1	P046	Anlg In4-20mA Lo	t095	Power Loss Mode	A548	
	Motor NP Poles	P035	Speed Reference1	P047	Anlg In4-20mA Hi	t096	Half Bus Enable	A549	
	Language	P030	Autotune	P040	Relay Out1 Sel	t076	Anlg In mA Loss	t097	
Output Freq	b001	Accel Time 1	P041	Analog Out Sel	t088	Preset Freq 0	A410		
Commanded Freq	b002	Decel Time 1	P042	Analog Out High	t089	Auto Rstrt Tries	A541		
Motor NP Volts	P031	Minimum Freq	P043	Anlg Out Setpt	t090	Auto Rstrt Delay	A542		

Centrifugal Pump									
		Motor OL Current	P033	Start Source 1	P046	Anlg In4-20mA Hi	t096	PID 1 Diff Rate	A463
		Motor NP FLA	P034	Speed Reference1	P047	Anlg In mA Loss	t097	PID 1 Setpoint	A464
		Motor NP Poles	P035	Relay Out1 Sel	t076	Preset Freq 0	A410	PID 1 Deadband	A465
		Autotune	P040	Analog Out Sel	t088	PID 1 Trim Hi	A456	PID 1 Preload	A466
Language	P030	Accel Time 1	P041	Analog Out High	t089	PID 1 Trim Lo	A457	Auto Rstrt Tries	A541
Output Freq	b001	Decel Time 1	P042	Anlg Out Setpt	t090	PID 1 Ref Sel	A459	Auto Rstrt Delay	A542
Commanded Freq	b002	Minimum Freq	P043	Anlg In 0-10V Lo	t091	PID 1 Fdbck Sel	A460	Start At PowerUp	A543
Motor NP Volts	P031	Maximum Freq	P044	Anlg In 0-10V Hi	t092	PID 1 Prop Gain	A461	Reverse Disable	A544
Motor NP Hertz	P032	Stop Mode	P045	Anlg In4-20mA Lo	t095	PID 1 Integ Time	A462		
Blower/Fan									
		Motor OL Current	P033	Start Source 1	P046	Anlg In4-20mA Hi	t096	PID 1 Diff Rate	A463
		Motor NP FLA	P034	Speed Reference1	P047	Anlg In mA Loss	t097	PID 1 Setpoint	A464
		Motor NP Poles	P035	Relay Out1 Sel	t076	Preset Freq 0	A410	PID 1 Deadband	A465
		Autotune	P040	Analog Out Sel	t088	PID 1 Trim Hi	A456	PID 1 Preload	A466
Language	P030	Accel Time 1	P041	Analog Out High	t089	PID 1 Trim Lo	A457	Auto Rstrt Tries	A541
Output Freq	b001	Decel Time 1	P042	Anlg Out Setpt	t090	PID 1 Ref Sel	A459	Auto Rstrt Delay	A542
Commanded Freq	b002	Minimum Freq	P043	Anlg In 0-10V Lo	t091	PID 1 Fdbck Sel	A460	Start At PowerUp	A543
Motor NP Volts	P031	Maximum Freq	P044	Anlg In 0-10V Hi	t092	PID 1 Prop Gain	A461	Reverse Disable	A544
Motor NP Hertz	P032	Stop Mode	P045	Anlg In4-20mA Lo	t095	PID 1 Integ Time	A462	Flying Start En	A545
Extruder									
		Motor NP Hertz	P032	Stop Mode	P045	Anlg In4-20mA Lo	t095	Encoder PPR	A536
		Motor OL Current	P033	Start Source 1	P046	Anlg In4-20mA Hi	t096	Pulse In Scale	A537
		Motor NP FLA	P034	Speed Reference1	P047	Anlg In mA Loss	t097	Ki Speed Loop	A538
		Motor NP Poles	P035	Relay Out1 Sel	t076	Slip Hz Meter	d375	Kp Speed Loop	A539
Language	P030	Autotune	P040	Analog Out Sel	t088	Speed Feedback	d376	Power Loss Mode	A548
Output Freq	b001	Accel Time 1	P041	Analog Out High	t089	Encoder Speed	d378	Half Bus Enable	A549
Commanded Freq	b002	Decel Time 1	P042	Anlg Out Setpt	t090	Preset Freq 0	A410		
Output Current	b003	Minimum Freq	P043	Anlg In 0-10V Lo	t091	Stall Fault Time	A492		
Motor NP Volts	P031	Maximum Freq	P044	Anlg In 0-10V Hi	t092	Motor Fdbk Type	A535		
Positioning⁽¹⁾									
		Stop Mode	P045	Stp Logic 5	L185	Step Units 6	L212	Jog Accel/Decel	A432
		Start Source 1	P046	Stp Logic 6	L186	Step Units 7	L214	DB Threshold	A438
		Speed Reference1	P047	Stp Logic 7	L187	Slip Hz Meter	d375	S Curve %	A439
		DigIn TermBlk 02	t062	Stp Logic Time 0	L190	Speed Feedback	d376	Motor Fdbk Type	A535
Language	P030	DigIn TermBlk 03	t063	Stp Logic Time 1	L191	Encoder Speed	d378	Encoder PPR	A536
Output Freq	b001	DigIn TermBlk 05	t065	Stp Logic Time 2	L192	Units Traveled H	d388	Pulse In Scale	A537
Commanded Freq	b002	DigIn TermBlk 06	t066	Stp Logic Time 3	L193	Units Traveled L	d389	Ki Speed Loop	A538
Motor NP Volts	P031	Opto Out1 Sel	t069	Stp Logic Time 4	L194	Preset Freq 0	A410	Kp Speed Loop	A539
Motor NP Hertz	P032	Opto Out2 Sel	t072	Stp Logic Time 5	L195	Preset Freq 1	A411	Bus Reg Enable	A550
Motor OL Current	P033	Relay Out1 Sel	t076	Stp Logic Time 6	L196	Preset Freq 2	A412	Positioning Mode	A558
Motor NP FLA	P034	EM Brk Off Delay	t086	Stp Logic Time 7	L197	Preset Freq 3	A413	Counts Per Unit	A559
Motor NP Poles	P035	EM Brk On Delay	t087	Step Units 0	L200	Preset Freq 4	A414	Enh Control Word	A560
Autotune	P040	Stp Logic 0	L180	Step Units 1	L202	Preset Freq 5	A415	Find Home Freq	A562
Accel Time 1	P041	Stp Logic 1	L181	Step Units 2	L204	Preset Freq 6	A416	Find Home Dir	A563
Decel Time 1	P042	Stp Logic 2	L182	Step Units 3	L206	Preset Freq 7	A417	Encoder Pos Tol	A564
Minimum Freq	P043	Stp Logic 3	L183	Step Units 4	L208	Preset Freq 8	A418	Pos Reg Filter	A565
Maximum Freq	P044	Stp Logic 4	L184	Step Units 5	L210	Jog Frequency	A431	Pos Reg Gain	A566
Textile/Fiber									
		Motor NP FLA	P034	DigIn TermBlk 02	t062	Slip Hz Meter	d375	Max Traverse	A567
		Motor NP Poles	P035	DigIn TermBlk 03	t063	Fiber Status	d390	Traverse Inc	A568
		Autotune	P040	Opto Out1 Sel	t069	Preset Freq 0	A410	Traverse Dec	A569
		Accel Time 1	P041	Opto Out2 Sel	t072	Jog Frequency	A431	P Jump	A570
Language	P030	Decel Time 1	P042	Relay Out1 Sel	t076	Jog Accel/Decel	A432	Sync Time	A571
Output Freq	b001	Minimum Freq	P043	Anlg In 0-10V Lo	t091	S Curve %	A439	Speed Ratio	A572
Commanded Freq	b002	Maximum Freq	P044	Anlg In 0-10V Hi	t092	Reverse Disable	A544		
Motor NP Volts	P031	Stop Mode	P045	Anlg In4-20mA Lo	t095	Power Loss Mode	A548		
Motor NP Hertz	P032	Start Source 1	P046	Anlg In4-20mA Hi	t096	Half Bus Enable	A549		
Motor OL Current	P033	Speed Reference1	P047	Anlg In mA Loss	t097	Bus Reg Enable	A550		

(1) This AppView parameter group is specific to PowerFlex 525 drives only.

CustomView Parameter Group

PowerFlex 520-series drives include a CustomView™ parameter group for you to store frequently used parameters for your application. See [CustomView Parameter Group on page 139](#) for more information.

Custom Group



This group can store up to 100 parameters.

Basic Display Group

b001 [Output Freq]

Related Parameter(s): [b002](#), [b010](#), [P043](#), [P044](#), [P048](#), [P050](#), [P052](#)

Output frequency present at T1, T2 & T3 (U, V & W). Does not include slip frequency.

Values	Default:	Read Only
	Min/Max:	0.00/[Maximum Freq]
	Display:	0.01 Hz

b002 [Commanded Freq]

Related Parameter(s): [b001](#), [b013](#), [P043](#), [P044](#), [P048](#), [P050](#), [P052](#)

Value of the active frequency command even if the drive is not running.

IMPORTANT The frequency command can come from a number of sources. See [Start and Speed Reference Control on page 46](#) for more information.

Values	Default:	Read Only
	Min/Max:	0.00/[Maximum Freq]
	Display:	0.01 Hz

b003 [Output Current]

Output current present at T1, T2 & T3 (U, V & W).

Values	Default:	Read Only
	Min/Max:	0.00/(Drive Rated Amps x 2)
	Display:	0.01 A

b004 [Output Voltage]

Related Parameter(s): [P031](#), [A530](#), [A534](#)

Output voltage present at T1, T2 & T3 (U, V & W).

Values	Default:	Read Only
	Min/Max:	0.0/Drive Rated Volts
	Display:	0.1V

b005 [DC Bus Voltage]

Filtered DC bus voltage level of the drive.

Values	Default:	Read Only
	Min/Max:	0/1200VDC
	Display:	1VDC

b006 [Drive Status]

Related Parameter(s): [A544](#)

Present operating condition of the drive.

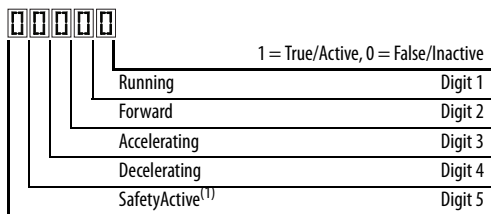

(1) Setting is specific to PowerFlex 525 drives only.

Values	Default:	Read Only
	Min/Max:	00000/11111
	Display:	00000

Basic Display Group (continued)

b007 [Fault 1 Code]
b008 [Fault 2 Code]
b009 [Fault 3 Code]

Related Parameter(s): [F604-F610](#)

A code that represents a drive fault. Codes appear in these parameters in the order they occur ([b007](#) [Fault 1 Code] = the most recent fault). Repetitive faults are only recorded once. See [Fault and Diagnostic Group](#) for more information.

Values	Default:	Read Only
	Min/Max:	F0/F127
	Display:	F0

b010 [Process Display]

Related Parameter(s): [b001](#), [A481](#), [A482](#)

 32 bit parameter.

Output frequency scaled by [Process Disp Hi] and [Process Disp Lo].

Values	Default:	Read Only
	Min/Max:	0/9999
	Display:	1

b012 [Control Source]

Related Parameter(s): [P046](#), [P047](#), [P048](#), [P049](#), [P050](#), [P051](#), [t062](#), [t063](#), [t065-t068](#), [L180-L187](#), [A410-A425](#)

Active source of the Start Command and Frequency Command. Normally defined by the settings of [P046](#), [P048](#), [P050](#) [Start Source x] and [P047](#), [P049](#), [P051](#) [Speed Reference x]. See [Start and Speed Reference Control on page 46](#) for more information.

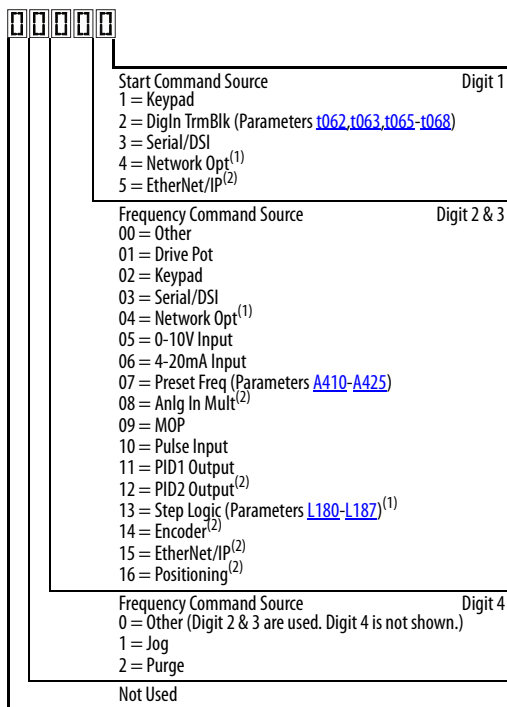

Example

Display reads...	Description
2004	Start source comes from Network Opt and Frequency source is Purge.
113	Start source comes from Serial/DSI and Frequency source comes from PID1 Output.
155	Start source and Frequency source comes from EtherNet/IP.
052	Start source comes from DigIn TrmBlk and Frequency source from 0-10V Input.
011	Start source comes from Keypad and Frequency source comes from Drive Pot.

(1) Select this setting if using the optional PowerFlex 25-COMM-E2P, 25-COMM-D, or 25-COMM-P adapters as the Start source and/or Frequency source.
 (2) Setting is specific to PowerFlex 525 drives only.

Values	Default:	Read Only
	Min/Max:	0000/2165
	Display:	0000

Basic Display Group (continued)

b013 [Contrl In Status]

Related Parameter(s): [b002](#), [P044](#), [P045](#)

State of the digital terminal blocks 1...3 and DB transistor.

IMPORTANT Actual control commands may come from a source other than the control terminal block.

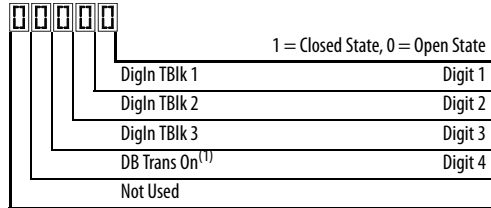

(1) The DB Transistor "on" indication must have a 0.5 s hysteresis. It will turn on and stay on for at least 0.5 s every time the DB transistor is turned on.

Values	Default:	Read Only
	Min/Max:	0000/1111
	Display:	0000

b014 [Dig In Status]

Related Parameter(s): [t065](#)-[t068](#)

State of the programmable digital inputs.

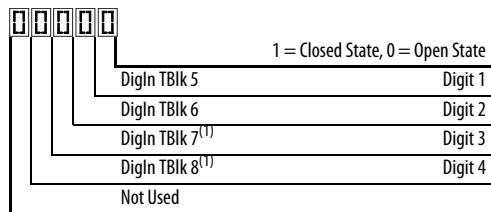

(1) Setting is specific to PowerFlex 525 drives only.

Values	Default:	Read Only
	Min/Max:	0000/1111
	Display:	0000

b015 [Output RPM]

Related Parameter(s): [P035](#)

Current output frequency in rpm. Scale is based on [P035](#) [Motor NP Poles].

Values	Default:	Read Only
	Min/Max:	0/24000 rpm
	Display:	1 rpm

b016 [Output Speed]

Related Parameter(s): [P044](#)

Current output frequency in %. Scale is 0% at 0.00 Hz to 100% at [P044](#) [Maximum Freq].

Values	Default:	Read Only
	Min/Max:	0.0/100.0%
	Display:	0.1%

b017 [Output Power]

Related Parameter(s): [b018](#)

Output power present at T1, T2 & T3 (U, V & W).

Values	Default:	Read Only
	Min/Max:	0.00/(Drive Rated Power x 2)
	Display:	0.01 kW

Basic Display Group *(continued)*

b018 [Power Saved]

Related Parameter(s): [b017](#)

Instantaneous power savings of using this drive compared to an across the line starter.

Values	Default:	Read Only
	Min/Max:	0.00/655.35 kW
	Display:	0.01 kW

b019 [Elapsed Run time]

Related Parameter(s): [A555](#)

Accumulated time drive is outputting power. Time is displayed in 10 hour increments.

Values	Default:	Read Only
	Min/Max:	0/65535 x 10 hr
	Display:	1 = 10 hr

b020 [Average Power]

Related Parameter(s): [A555](#)

Average power used by the motor since the last reset of the meters.

Values	Default:	Read Only
	Min/Max:	0.00/(Drive Rated Power x 2)
	Display:	0.01 kW

b021 [Elapsed kWh]

Related Parameter(s): [b022](#)Accumulated output energy of the drive. When the maximum value of this parameter is reached, it resets to zero and [b022](#) [Elapsed MWh] is incremented.

Values	Default:	Read Only
	Min/Max:	0.0/100.0 kWh
	Display:	0.1 kWh

b022 [Elapsed MWh]

Related Parameter(s): [b021](#)

Accumulated output energy of the drive.

Values	Default:	Read Only
	Min/Max:	0.0/6553.5 MWh
	Display:	0.1 MWh

b023 [Energy Saved]

Related Parameter(s): [A555](#)

Total energy savings of using this drive compared to an across the line starter since the last reset of the meters.

Values	Default:	Read Only
	Min/Max:	0.0/6553.5 kWh
	Display:	0.1 kWh

b024 [Accum kWh Sav]

Related Parameter(s): [b025](#)

Total approximate accumulated energy savings of the drive compared to using an across the line starter.

Values	Default:	Read Only
	Min/Max:	0.0/6553.5 kWh
	Display:	0.1 = 10 kWh

Basic Display Group (continued)

b025 [Accum Cost Sav]

 Related Parameter(s): [b024](#), [P052](#), [A555](#)

Total approximate accumulated cost savings of the drive compared to using an across the line starter.

$[\text{Accum Cost Sav}] = [\text{Average kWh cost}] \times [\text{Accum kWh Sav}]$

Values	Default:	Read Only
	Min/Max:	0.0/6553.5
	Display:	0.1

b026 [Accum CO2 Sav]

 Related Parameter(s): [A555](#)

Total approximate accumulated CO2 savings of the drive compared to using an across the line starter.

Values	Default:	Read Only
	Min/Max:	0.0/6553.5 kg
	Display:	0.1 kg

b027 [Drive Temp]

Present operating temperature of the drive heatsink (inside module).

Values	Default:	Read Only
	Min/Max:	0/120 °C
	Display:	1 °C

b028 [Control Temp]

Present operating temperature of the drive control.

Values	Default:	Read Only
	Min/Max:	0/120 °C
	Display:	1 °C

b029 [Control SW Ver]

Current drive firmware version.

Values	Default:	Read Only
	Min/Max:	0.000/65.535
	Display:	0.001

Basic Program Group

P030 [Language]

Selects the language displayed. A reset or power cycle is required after selection is made.

Language Support

		Keypad/ LCD Display	RSLogix 5000/ Logix Designer	Connected Components Workbench
Options	1 English (Default)	Y	Y	Y
	2 Français	Y	Y	Y
	3 Español	Y	Y	Y
	4 Italiano	Y	Y	Y
	5 Deutsch	Y	Y	Y
	6 Japanese	–	Y	–
	7 Português	Y	Y	–
	8 Chinese Chinese Simplified	–	Y	Y
	9 Reserved			
	10 Reserved			
	11 Korean	–	Y	–
	12 Polish ⁽¹⁾	Y	–	–
	13 Reserved			
	14 Turkish ⁽¹⁾	Y	–	–
	15 Czech ⁽¹⁾	Y	–	–

(1) Due to a limitation of the LCD Display, some of the characters for Polish, Turkish, and Czech will be modified.

P031 [Motor NP Volts]

Related Parameter(s): [b004](#), [A530](#), [A531](#), [A532](#), [A533](#)

 Stop drive before changing this parameter.

Sets the motor nameplate rated volts.

Values	Default:	Drive Rated Volts
	Min/Max:	10V (for 230V Drives), 20V (for 460V Drives), 25V (for 600V Drives)/Drive Rated Volts
	Display:	1V

P032 [Motor NP Hertz]

Related Parameter(s): [A493](#), [A530](#), [A531](#), [A532](#), [A533](#)

 Stop drive before changing this parameter.

Sets the motor nameplate rated frequency.

Values	Default:	60 Hz
	Min/Max:	15/500 Hz
	Display:	1 Hz

P033 [Motor OL Current]

Related Parameter(s): [t069](#), [t072](#), [t076](#), [t081](#), [A484](#), [A485](#), [A493](#)

Sets the motor nameplate overload current. Used to determine motor overload conditions and can be set from 0.1 A to 200% of drive rated current.

IMPORTANT The drive will fault on an F007 “Motor Overload” if the value of this parameter is exceeded by 150% for 60 s.

Values	Default:	Drive Rated Amps
	Min/Max:	0.0/(Drive Rated Amps x 2)
	Display:	0.1 A

Basic Program Group *(continued)***P034 [Motor NP FLA]**Related Parameter(s): [P040](#)

Sets the motor nameplate FLA. Used to assist the Autotune routine and motor control.

Values	Default:	Based on Drive Rating
	Min/Max:	0.1/(Drive Rated Amps x 2)
	Display:	0.1 A

P035 [Motor NP Poles]Related Parameter(s): [b015](#)

Sets the number of poles in the motor.

Values	Default:	4
	Min/Max:	2/40
	Display:	1

P036 [Motor NP RPM] Stop drive before changing this parameter.

Sets the rated nameplate rpm of the motor. Used to calculate the rated slip of the motor. To reduce the slip frequency, set this parameter closer to the motor synchronous speed.

Values	Default:	1750 rpm
	Min/Max:	0/24000 rpm
	Display:	1 rpm

P037 [Motor NP Power](PF 525) PowerFlex 525 only.

Sets the motor nameplate power. Used in PM regulator.

Values	Default:	Drive Rated Power
	Min/Max:	0.00/Drive Rated Power
	Display:	0.01 kW

P038 [Voltage Class] Stop drive before changing this parameter.

Sets the voltage class of 600V drives. Only applicable to 600V drives.

Options	2	"480V"
	3	"600V" (Default)

P039 [Torque Perf Mode]Related Parameter(s): [P040](#), [A530](#), [A531](#), [A532](#), [A533](#) Stop drive before changing this parameter.

Selects the motor control mode.

Options	0	"V/Hz"
	1	"SVC" (Default)
	2	"Economize"
	3	"Vector" ⁽¹⁾

(1) Setting is specific to PowerFlex 525 drives only.

Basic Program Group (continued)

P040 [Autotune]

Related Parameter(s): [P034](#), [P039](#), [A496](#), [A497](#)

 Stop drive before changing this parameter.

Enables a static (not spinning) or dynamic (motor spinning) autotune to automatically set the motor parameters. Start must be pressed to begin the routine. After the routine is complete the parameter resets to a zero. A failure (such as if a motor is not connected) results in an Autotune Fault.

IMPORTANT

All motor parameters in the Basic Program group must be set before running the routine. If a start command is not given (or a stop command is given) within 30 s, the parameter automatically returns to a zero and an Autotune Fault occurs.



ATTENTION: Rotation of the motor in an undesired direction can occur during this procedure. To guard against possible injury and/or equipment damage, it is recommended that the motor be disconnected from the load before proceeding.

Options	0 "Ready/Idle" (Default)	
	1 "Static Tune"	A temporary command that initiates a non-rotational motor stator resistance test for the best possible automatic setting of A496 [IR Voltage Drop]. A start command is required following initiation of this setting. The parameter returns to 0 "Ready/Idle" following the test, at which time another start transition is required operate the drive in normal mode. Used when motor cannot be uncoupled from the load.
	2 "Rotate Tune"	A temporary command that initiates a "Static Tune" followed by a rotational test for the best possible automatic setting of A497 [Flux Current Ref]. A start command is required following initiation of this setting. The parameter returns to 0 "Ready/Idle" following the test, at which time another start transition is required to operate the drive in normal mode. Important: Used when motor is uncoupled from the load. Results may not be valid if a load is coupled to the motor during this procedure.

P041 [Accel Time 1]

Related Parameter(s): [P044](#), [A439](#)

Sets the time for the drive to accelerate from 0 Hz to [P044](#) [Maximum Freq].

$$\text{Accel Rate} = [\text{Maximum Freq}] / [\text{Accel Time } x]$$

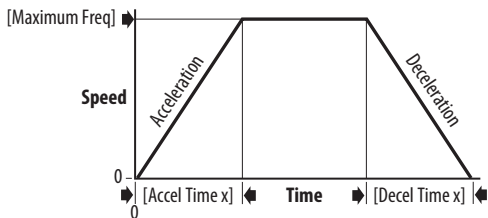

Values	Default:	10.00 s
	Min/Max:	0.00/600.00 s
	Display:	0.01 s

P042 [Decel Time 1]

Related Parameter(s): [P044](#), [A439](#)

Sets the time for the drive to decelerate from [P044](#) [Maximum Freq] to 0 Hz.

$$\text{Decel Rate} = [\text{Maximum Freq}] / [\text{Decel Time } x]$$

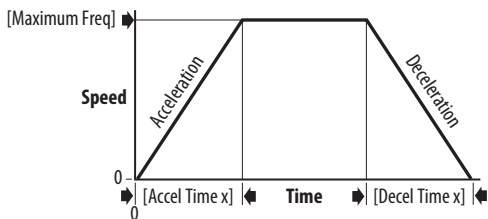

Values	Default:	10.00 s
	Min/Max:	0.00/600.00 s
	Display:	0.01 s

Basic Program Group (continued)

P043 [Minimum Freq]

Related Parameter(s): [b001](#), [b002](#), [b013](#), [P044](#), [A530](#), [A531](#)

 Stop drive before changing this parameter.

Sets the lowest frequency the drive outputs.

Values	Default:	0.00 Hz
	Min/Max:	0.00/500.00 Hz
	Display:	0.01 Hz

P044 [Maximum Freq]

Related Parameter(s): [b001](#), [b002](#), [b013](#), [b016](#), [P043](#), [A530](#), [A531](#)

 Stop drive before changing this parameter.

Sets the highest frequency the drive outputs.

IMPORTANT This value must be greater than the value set in P043 [Minimum Freq].

Values	Default:	60.00 Hz
	Min/Max:	0.00/500.00 Hz
	Display:	0.01 Hz

P045 [Stop Mode]

Related Parameter(s): [t086](#), [t087](#), [A434](#), [A435](#), [A550](#)

Determines the stopping mode used by the drive when a stop is initiated.

Options	0 "Ramp, CF" (Default)	Ramp to Stop. Stop command clears active fault.
	1 "Coast, CF"	Coast to Stop. Stop command clears active fault.
	2 "DC Brake, CF"	DC Injection Braking Stop. Stop command clears active fault.
	3 "DC BrkAuto,CF"	DC Injection Braking Stop with Auto Shutoff. <ul style="list-style-type: none"> Standard DC Injection Braking for value set in A434 [DC Brake Time]. OR Drive shuts off if the drive detects that the motor is stopped. Stop command clears active fault.
	4 "Ramp"	Ramp to Stop.
	5 "Coast"	Coast to Stop.
	6 "DC Brake"	DC Injection Braking Stop.
	7 "DC BrakeAuto"	DC Injection Braking Stop with Auto Shutoff. <ul style="list-style-type: none"> Standard DC Injection Braking for value set in A434 [DC Brake Time]. OR Drive shuts off if the drive detects that the motor is stopped.
	8 "Ramp+EM B,CF"	Ramp to Stop with EM Brake Control. Stop command clears active fault.
	9 "Ramp+EM Brk"	Ramp to Stop with EM Brake Control.
	10 "PointStp,CF"	PointStop. Stop command clears active fault.
	11 "PointStop"	PointStop.

Provides a method to stop at a constant distance instead of a fixed rate. When a Stop command is given, the distance required for the machine to travel to standstill based on the programmed maximum speed and deceleration time is calculated. If the drive is running slower than the maximum speed, the function will apply a calculated deceleration time that allows the machine to travel to standstill in the same distance based on the current speed. It is recommended to use braking resistors or set [A550](#) [Bus Reg Enable] to 0 "Disabled" for better performance.

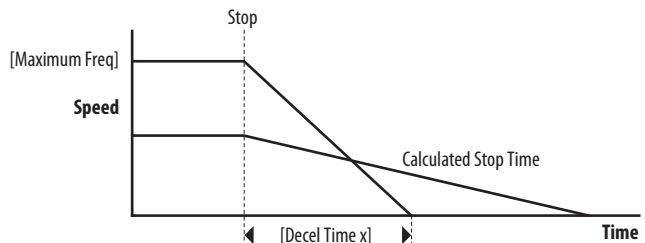

Basic Program Group *(continued)*

P046 [Start Source 1]
P048 [Start Source 2]
P050 [Start Source 3]

Related Parameter(s): [b012](#), [t064](#), [C125](#)

 Stop drive before changing this parameter.

Configures the start source of the drive. Changes to these inputs take effect as soon as they are entered. P046 [Start Source 1] is the factory default start source unless overridden. See [Start and Speed Reference Control on page 46](#) for more information.

IMPORTANT For all settings except when t064 [2-Wire Mode] is set to 1 “Level Sense”, the drive must receive a leading edge from the start input for the drive to start after a stop input, loss of power, or fault condition.

Options		
1	“Keypad”	[Start Source 1] default
2	“DigIn TrmBlk”	[Start Source 2] default
3	“Serial/DSI”	[Start Source 3] default for PowerFlex 523
4	“Network Opt” ⁽¹⁾	
5	“EtherNet/IP” ⁽²⁾	[Start Source 3] default for PowerFlex 525

- (1) Select this setting if using the optional PowerFlex 25-COMM-E2P, 25-COMM-D, or 25-COMM-P adapters as the start source.
- (2) Setting is specific to PowerFlex 525 drives only.

P047 [Speed Reference1]
P049 [Speed Reference2]
P051 [Speed Reference3]

Related Parameter(s): [C125](#)

Selects the source of speed command for the drive. Changes to these inputs take effect as soon as they are entered. P047 [Speed Reference1] is the factory default speed reference unless overridden.

See [Start and Speed Reference Control on page 46](#) for more information.

Options		
1	“Drive Pot”	[Speed Reference1] default
2	“Keypad Freq”	
3	“Serial/DSI”	[Speed Reference3] default for PowerFlex 523
4	“Network Opt” ⁽¹⁾	
5	“0-10V Input”	[Speed Reference2] default
6	“4-20mA Input”	
7	“Preset Freq”	
8	“Anlg In Mult” ⁽²⁾	
9	“MOP”	
10	“Pulse Input”	
11	“PID1 Output”	
12	“PID2 Output” ⁽²⁾	
13	“Step Logic” ⁽²⁾	
14	“Encoder” ⁽²⁾	
15	“EtherNet/IP” ⁽²⁾	[Speed Reference3] default for PowerFlex 525
16	“Positioning” ⁽²⁾	Referencing from A558 [Positioning Mode]

- (1) Select this setting if using the optional PowerFlex 25-COMM-E2P, 25-COMM-D, or 25-COMM-P adapters as the speed reference.
- (2) Setting is specific to PowerFlex 525 drives only.

P052 [Average kWh Cost]

Related Parameter(s): [b025](#)

Sets the average cost per kWh.

Values		
Default:		0.00
Min/Max:		0.00/655.35
Display:		0.01

Basic Program Group *(continued)*

P053 [Reset To Defaults]



Stop drive before changing this parameter.

Resets all parameters to their factory default values. After a Reset command, the value of this parameter returns to zero.

Parameters that are NOT Reset when P053 = 1

Parameter
P030 [Language]
C121 [Comm Write Mode]
C122 [Cmd Stat Select]
C123 [RS485 Data Rate]
C124 [RS485 Node Addr]
C124 [Comm Loss Action]
C126 [Comm Loss Time]
C127 [RS485 Format]
C128 [EN Addr Sel]
C129 [EN IP Addr Cfg 1]
C130 [EN IP Addr Cfg 2]
C131 [EN IP Addr Cfg 3]
C132 [EN IP Addr Cfg 4]
C133 [EN Subnet Cfg 1]
C134 [EN Subnet Cfg 2]
C135 [EN Subnet Cfg 3]
C136 [EN Subnet Cfg 4]
C137 [EN Gateway Cfg 1]

Parameter
C138 [EN Gateway Cfg 2]
C139 [EN Gateway Cfg 3]
C140 [EN Gateway Cfg 4]
C141 [EN Rate Cfg]
C143 [EN Comm Flt Actn]
C144 [EN Idle Flt Actn]
C145 [EN Flt Cfg Logic]
C146 [EN Flt Cfg Ref]
C147 [EN Flt Cfg DL 1]
C148 [EN Flt Cfg DL 2]
C149 [EN Flt Cfg DL 3]
C150 [EN Flt Cfg DL 4]
C153 [EN Data In 1]
C154 [EN Data In 2]
C155 [EN Data In 3]
C156 [EN Data In 4]
C157 [EN Data Out 1]
C158 [EN Data Out 2]

Parameter
C159 [EN Data Out 3]
C160 [EN Data Out 4]
C161 [Opt Data In 1]
C162 [Opt Data In 2]
C163 [Opt Data In 3]
C164 [Opt Data In 4]
C165 [Opt Data Out 1]
C166 [Opt Data Out 2]
C167 [Opt Data Out 3]
C168 [Opt Data Out 4]
C169 [MultiDrv Sel]
C171 [Drv 1 Addr]
C172 [Drv 2 Addr]
C173 [Drv 3 Addr]
C174 [Drv 4 Addr]
C175 [DSI I/O Cfg]
GC [Parameters in Custom Group]

Parameters that are Reset when P053 = 3

Parameter Name
P031 [Motor NP Volts]
P033 [Motor OL] Current
P034 [Motor NP FLA]
P035 [Motor NP Poles]
P038 [Voltage Class]
A435 [DC Brake Level]
A484 [Current Limit 1]
A485 [Current Limit 2]
A486 [Shear Pin1 Level]
A488 [Shear Pin2 Level]
A490 [Load Loss Level]
A496 [IR Voltage Drop]
A497 [Flux Current Ref]
A530 [Boost Select]
A531 [Start Boost]
A532 [Break Voltage]
A533 [Break Frequency]
A534 [Maximum] Voltage

Options	0 "Ready/Idle" (Default)
1 "Param Reset"	Does not reset custom groups, parameter P030 [Language], and communication parameters.
2 "Factory Rset"	Restore drive to factory condition.
3 "Power Reset"	Resets only power parameters. Can be used when swapping power modules.

Terminal Block Group

t062 [DigIn TermBlk 02] t063 [DigIn TermBlk 03]
 t065 [DigIn TermBlk 05] t066 [DigIn TermBlk 06]



Related Parameter(s): [b012](#), [b013](#), [b014](#), [P045](#), [P046](#), [P048](#), [P049](#), [P050](#), [P051](#), [t064](#), [t086](#), [A410-A425](#), [A427](#), [A431](#), [A432](#), [A433](#), [A434](#), [A435](#), [A442](#), [A443](#), [A488](#), [A535](#), [A560](#), [A562](#), [A563](#), [A567](#), [A571](#)

t067 [DigIn TermBlk 07] t068 [DigIn TermBlk 08]
 [PF 525] PowerFlex 525 only.

 Stop drive before changing this parameter.

Programmable digital input. Changes to these inputs takes effect as soon as they are entered. If a digital input is set for a selection that is only usable on one input, no other input can be set for the same selection.

Options	0	"Not Used"	Terminal has no function but can be read over network communications with b013 [Contrl In Status] and b014 [Dig In Status].
	1	"Speed Ref 2"	Selects P049 [Speed Reference2] as drive's speed command.
	2	"Speed Ref 3"	Selects P051 [Speed Reference3] as drive's speed command.
	3	"Start Src 2"	Selects P048 [Start Source 2] as control source to start the drive.
	4	"Start Src 3"	Selects P050 [Start Source 3] as control source to start the drive.
	5	"Spd + Strt 2"	[DigIn TermBlk 07] default. Selects combination of P049 [Speed Reference2] and P048 [Start Source 2] as speed command with control source to start the drive.
	6	"Spd + Strt 3"	Selects combination of P051 [Speed Reference3] and P050 [Start Source 3] as speed command with control source to start the drive.
	7	"Preset Freq" (PF523: only for DigIn TermBlk 03, 05, and 06) (PF525: only for DigIn TermBlk 05...08)	[DigIn TermBlk 05] and [DigIn TermBlk 06] default. <ul style="list-style-type: none"> Selects a preset frequency in Velocity mode (P047, P049, P051 [Speed Referencex] = 1...15). See A410...A425 [Preset Freq x]. Selects a preset frequency and position in Positioning mode (P047, P049, P051 [Speed Referencex] = 16). See L200...L214 [Step Units x] (only for PowerFlex 525 drives).
			IMPORTANT Digital Inputs have priority for frequency control when programmed as Preset Speed and are active. See Start Source and Speed Reference Selection on page 46 for more information.
	8	"Jog"	<ul style="list-style-type: none"> When input is present, drive accelerates according to the value set in A432 [Jog Accel/Decel] and ramps to the value set in A431 [Jog Frequency]. When input is removed, drive ramps to a stop according to the value set in A432 [Jog Accel/Decel]. A valid Start command will override this input.
	9	"Jog Forward"	[DigIn TermBlk 08] default. Drive accelerates to A431 [Jog Frequency] according to A432 [Jog Accel/Decel] and ramps to a stop when input becomes inactive. A valid Start command will override this input.
	10	"Jog Reverse"	Drive accelerates to A431 [Jog Frequency] according to A432 [Jog Accel/Decel] and ramps to a stop when input becomes inactive. A valid Start command will override this input.
	11	"Acc/Dec Sel2" ⁽¹⁾	If active, determines which Accel/Decel time will be used for all ramp rates except jog. Can be used with option 29 "Acc/Dec Sel3" for additional Accel/Decel times. See A442 [Accel Time 2] for more information.
	12	"Aux Fault"	When enabled, an F002 "Auxiliary Input" fault will occur when the input is removed.
	13	"Clear Fault"	When active, clears an active fault.
	14	"RampStop,CF"	Causes drive to immediately ramp to a stop regardless of how P045 [Stop Mode] is set.
	15	"CoastStop,CF"	Causes drive to immediately coast to a stop regardless of how P045 [Stop Mode] is set.
	16	"DCInjStop,CF"	Causes drive to immediately begin a DC Injection stop regardless of how P045 [Stop Mode] is set.
	17	"MOP Up"	Increases the value of A427 [MOP Freq] at the rate set in A430 [MOP Time].
	18	"MOP Down"	Decreases the value of A427 [MOP Freq] at the rate set in A430 [MOP Time].
	19	"Timer Start" ⁽¹⁾	Clears and starts the timer function. May be used to control the relay or opto outputs.
	20	"Counter In" ⁽¹⁾	Starts the counter function. May be used to control the relay or opto outputs.
	21	"Reset Timer"	Clears the active timer.
	22	"Reset Countr"	Clears the active counter.
	23	"Rset Tim&Cnt"	Clear the active timer and counter.
	24	"Logic In 1" ⁽¹⁾⁽²⁾	Logic function input number 1. May be used to control the relay or opto outputs (t076 , t081 [Relay Outx Sel] and t069 , t072 [Opto Outx Sel], options 11...14). May be used in conjunction with StepLogic parameters L180...L187 [Stp Logic x].
	25	"Logic In 2" ⁽¹⁾⁽²⁾	Logic function input number 2. May be used to control the relay or opto outputs (t076 , t081 [Relay Outx Sel] and t069 , t072 [Opto Outx Sel], options 11...14). May be used in conjunction with StepLogic parameters L180...L187 [Stp Logic x].

Options	26 "Current Lmt2" ⁽²⁾	When active, A485 [Current Limit 2] determines the drive current limit level.																	
	27 "Anlg Invert"	Inverts the scaling of the analog input levels set in t091 [Anlg In 0-10V Lo] and t092 [Anlg In 0-10V Hi] or t095 [Anlg In4-20mA Lo] and t096 [Anlg In4-20mA Hi].																	
	28 "EM Brk Rlse"	If EM brake function is enabled, this input releases the brake. See t086 [EM Brk Off Delay] for more information.																	
		 ATTENTION: If a hazard of injury due to movement of equipment or material exists, an auxiliary mechanical braking device must be used.																	
	29 "Acc/Dec Sel3" ⁽¹⁾	<p>If active, determines which Accel/Decel time is used for all ramp rates except jog. Used with option 11 "Acc/Dec Sel2" for the Accel/Decel times listed in this table.</p> <table border="1" data-bbox="1263 478 1469 674"> <thead> <tr> <th colspan="2">Option</th> <th rowspan="2">Description</th> </tr> <tr> <th>29</th> <th>11</th> </tr> </thead> <tbody> <tr> <td>0</td> <td>0</td> <td>Acc/Dec 1</td> </tr> <tr> <td>0</td> <td>1</td> <td>Acc/Dec 2</td> </tr> <tr> <td>1</td> <td>0</td> <td>Acc/Dec 3</td> </tr> <tr> <td>1</td> <td>1</td> <td>Acc/Dec 4</td> </tr> </tbody> </table>	Option		Description	29	11	0	0	Acc/Dec 1	0	1	Acc/Dec 2	1	0	Acc/Dec 3	1	1	Acc/Dec 4
Option		Description																	
29	11																		
0	0	Acc/Dec 1																	
0	1	Acc/Dec 2																	
1	0	Acc/Dec 3																	
1	1	Acc/Dec 4																	
	30 "Precharge En"	Forces drive into precharge state. Typically controlled by auxiliary contact on the disconnect at the DC input to the drive. If this input is assigned, it must be energized for the pre-charge relay to close and for the drive to run. If it is de-energized, the pre-charge relay opens and the drive coasts to a stop.																	
	31 "Inertia Dcel"	Forces drive into Inertia Ride-Through state. The drive attempts to regulate the DC bus at the current level.																	
	32 "Sync Enable"	Must be used in order to hold the existing frequency when Sync Time is set to enable speed synchronization. When this input is released the drive accelerates to the commanded frequency in A571 [Sync Time].																	
	33 "Traverse Dis"	When an input is programmed the traverse function is disabled while this input is active. See A567 [Max Traverse].																	
	34 "Home Limit" ⁽²⁾	In Positioning mode, indicates the drive is at the home position. See Appendix E for more information on Positioning.																	
	35 "Find Home" ⁽²⁾	In Positioning mode, causes the drive to return to the Home position when a Start command is issued. Uses A562 [Find Home Freq] and A563 [Find Home Dir] until the "Home Limit" input is activated. If it passes this point, it then runs in the reverse direction at 1/10th the frequency of [Find Home Freq] until the "Home Limit" is activated again. As long as this input is active, any start command causes the drive to enter the homing routine. Only functions if in Positioning mode. Once the Find Home routine has finished, the drive stops. See Appendix E for more information on Positioning.																	
	36 "Hold Step" ⁽²⁾	<p>In Positioning mode, overrides other inputs and causes the drive to remain at its current step (running at zero speed once it reaches its position) until released.</p> <p>While in "Hold", the drive ignores any input command which would normally result in a move to a new step. Timers continue to run. Therefore, when the Hold is removed, the drive must see any required digital inputs transition (even if they already transitioned during the hold), but it does not reset any timer. See Appendix E for more information on Positioning.</p>																	
	37 "Pos Redefine" ⁽²⁾	In Positioning mode, resets the home position to the current position of the machine. See Appendix E for more information on Positioning.																	
	38 "Force DC"	If the drive is not running, causes the drive to apply a DC Holding current (A435 [DC Brake Level], ignoring A434 [DC Brake Time]) while the input is applied.																	
	39 "Damper Input"	When active, drive is allowed to run normally. When inactive, drive is forced into sleep mode and is prevented from accelerating to command speed.																	
	40 "Purge" ⁽¹⁾	Starts the drive at A433 [Purge Frequency] regardless of the selected control source. Supersedes the keypad Control function as well as any other control command to take control of the drive. Purge can occur, and is operational, at any time whether the drive is running or stopped regardless of the selected logic source selection. If a valid stop (other than from comms or SW enable) is present, the drive will not start on the purge input transition.																	
		 ATTENTION: If a hazard of injury due to movement of equipment or material exists, an auxiliary mechanical braking device must be used.																	
	41 "Freeze-Fire"	When inactive, will cause an immediate F094 "Function Loss" fault. Use to safely bypass the drive with an external switching device.																	
	42 "SW Enable"	Works like an interlock that has to be active for the drive to run.																	
	43 "ShearPin1 Dis"	Disables shear pin 1 but leaves shear pin 2 active. If A488 [Shear Pin 2 Level] is greater than 0.0 A, shear pin 2 is enabled.																	
	44 Reserved																		
	45 Reserved																		
	46 Reserved																		
	47 Reserved																		

Options	48 "2-Wire FWD" (only for DigIn TermBlk 02)	[DigIn TermBlk 02] default. Select 2-Wire FWD for this input. Select this option and set P046 , P048 or P050 [Start Source x] to 2 "DigIn TrmBlk" to configure [Start Source x] to a 2-wire run forward mode. Also see t064 [2-Wire Mode] for level trigger settings.
	49 "3-Wire Start" (only for DigIn TermBlk 02)	Select 3-Wire Start for this input. Select this option and set P046 , P048 or P050 [Start Source x] to 2 "DigIn TrmBlk" to configure [Start Source x] to a 3-wire start mode.
	50 "2-Wire REV" (only for DigIn TermBlk 03)	[DigIn TermBlk 03] default. Select 2-Wire REV for this input. Select this option and set P046 , P048 or P050 [Start Source x] to 2 "DigIn TrmBlk" to configure [Start Source x] to a 2-wire run reverse mode. Also see t064 [2-Wire Mode] for level trigger settings. For PowerFlex 523 drives, this setting will be disabled if [DigIn TermBlk 03] is set to 7 "Preset Freq".
	51 "3-Wire Dir" (only for DigIn TermBlk 03)	Select 3-Wire Dir for this input. Select this option and set P046 , P048 or P050 [Start Source x] to change the direction of [Start Source x]. For PowerFlex 523 drives, this setting will be disabled if [DigIn TermBlk 03] is set to 7 "Preset Freq".
	52 "Pulse Train" (PF523: only for DigIn TermBlk 05) (PF525: only for DigIn TermBlk 07)	Select pulse train for this input. Use P047 , P049 and P051 [Speed Referencex] to select pulse input. Jumper for DigIn TermBlk 05 or 07 Sel must be moved to Pulse In.

- (1) This function may be tied to one input only.
- (2) Setting is specific to PowerFlex 525 drives only.

t064 [2-Wire Mode]

Related Parameter(s): [P045](#), [P046](#), [P048](#), [P050](#), [t062](#), [t063](#)

 Stop drive before changing this parameter.

Programs the mode of trigger only for [t062](#) [DigIn TermBlk 02] and [t063](#) [DigIn TermBlk 03] when 2-wire option is being selected as [P046](#), [P048](#) or [P050](#) [Start Source x].

Options	0 "Edge Trigger" (Default)	Standard 2-Wire operation.
	1 "Level Sense"	<ul style="list-style-type: none"> • I/O Terminal 01 "Stop" = Coast to stop. Drive will restart after a Stop command when: <ul style="list-style-type: none"> – Stop is removed and – Start is held active • I/O Terminal 03 "Run REV"
 <p>ATTENTION: Hazard of injury exists due to unintended operation. When t064 [2-Wire Mode] is set to option 1, and the Run input is maintained, the Run inputs do not need to be toggled after a Stop input for the drive to run again. A Stop function is provided only when the Stop input is active (open).</p>		
	2 "Hi-Spd Edge"	<p>IMPORTANT There is greater potential voltage on the output terminals when using this option.</p> <ul style="list-style-type: none"> • Outputs are kept in a ready-to-run state. The drive will respond to a Start command within 10 ms. • I/O Terminal 01 "Stop" = Coast to stop. • I/O Terminal 03 "Run REV"
	3 "Momentary"	<ul style="list-style-type: none"> • Drive will start after a momentary input from either the Run FWD input (I/O Terminal 02) or the Run REV input (I/O Terminal 03). • I/O Terminal 01 "Stop" = Stop according to the value set in P045 [Stop Mode].

Terminal Block Group (continued)

t069 [Opto Out1 Sel]
t072 [Opto Out2 Sel]

Related Parameter(s): [P046](#), [P048](#), [P050](#), [t070](#), [t073](#), [t077](#), [t082](#), [t086](#), [t087](#), [t093](#), [t094](#), [t097](#), [A541](#), [A564](#)

(PF 525) PowerFlex 525 only.

Determines the operation of the programmable digital outputs.

Options	Setting Output Changes State When...	Hysteresis
0 "Ready/Fault"	Opto outputs are active when power is applied. Indicates that the drive is ready for operation. Opto outputs are inactive when power is removed or a fault occurs.	None
1 "At Frequency"	Drive reaches commanded frequency.	0.5 Hz above; 1.0 Hz below
2 "MotorRunning"	Motor is receiving power from the drive.	None
3 "Reverse"	Drive is commanded to run in reverse direction.	None
4 "Motor Overld"	Motor overload condition exists.	100 ms time delay on or off
5 "Ramp Reg"	Ramp regulator is modifying the programmed accel/decel times to avoid an overcurrent or overvoltage fault from occurring.	100 ms time delay on or off
6 "Above Freq"	Drive exceeds the frequency (Hz) value set in t070 or t073 [Opto Outx Level].	100 ms time delay on or off
7 "Above Cur"	Drive exceeds the current (% Amps) value set in t070 or t073 [Opto Outx Level]. IMPORTANT Value for t070 or t073 [Opto Outx Level] must be entered in percent of drive rated output current.	100 ms time delay on or off
8 "Above DCVolt"	Drive exceeds the DC bus voltage value set in t070 or t073 [Opto Outx Level].	100 ms time delay on or off
9 "Retries Ext"	Value set in A541 [Auto Rstrt Tries] is exceeded.	None
10 "Above Anlg V"	Analog input voltage (0-10V input) exceeds the value set in t070 or t073 [Opto Outx Level]. IMPORTANT Do not use if t093 [10V Bipolar Enbl] is set to 1 "Bi-Polar In".	100 ms time delay on or off
11 "Above PF Ang"	Power Factor angle exceeds the value set in t070 or t073 [Opto Outx Level].	100 ms time delay on or off
12 "Anlg In Loss"	Analog input loss has occurred. Program t094 [Anlg In V Loss] or t097 [Anlg In mA Loss] for desired action when input loss occurs.	On, 2 mA / ±1V Off, 3 mA / ±1.5V
13 "ParamControl"	Output is directly controlled by the state of the t070 or t073 [Opto Outx Level]. A value of 0 causes the output to turn off. A value of 1 or greater in this parameter causes the output to turn on.	None
14 "NonRec Fault"	<ul style="list-style-type: none"> Value set in A541 [Auto Rstrt Tries] is exceeded or A541 [Auto Rstrt Tries] is not enabled or A non-resettable fault has occurred. 	None
15 "EM Brk Cntrl"	EM Brake is energized. Program t087 [EM Brk On Delay] and t086 [EM Brk Off Delay] for desired action.	None
16 "Thermal OL"	Relay energizes when thermal Motor overload counter is above the value set in t077 or t082 [Relay Outx Level]. It also energizes if the drive is within 5 °C of the drive overheat trip point.	None
17 "Amb OverTemp"	Relay energizes when control module over temperature occurs.	None
18 "Local Active"	Active when drive P046 , P048 or P050 [Start Source x] is in local keypad control.	None
19 "Comm Loss"	Active when communication is lost from any comm source with reference or control.	None
20 "Logic In 1"	An input is programmed as "Logic Input 1" and is active.	None
21 "Logic In 2"	An input is programmed as "Logic Input 2" and is active.	None
22 "Logic 1 & 2"	Both Logic inputs are programmed and active.	None
23 "Logic 1 or 2"	One or both Logic inputs are programmed and one or both is active.	None
24 "StpLogic Out"	Drive enters StepLogic step with Command Word set to enable Logic output.	None
25 "Timer Out"	Timer has reached the value set in t070 or t073 [Opto Outx Level] or not timing.	None
26 "Counter Out"	Counter has reached the value set in t070 or t073 [Opto Outx Level] or not counting.	None
27 "At Position"	Drive is in Positioning mode and has reached the commanded position. Tolerance is adjusted with A564 [Encoder Pos Tol].	–
28 "At Home"	Drive is in Positioning mode and has reached the home position. Tolerance is adjusted with A564 [Encoder Pos Tol].	–
29 "Safe-Off"	Both safe-off inputs are active.	–

Values	Default:	
Opto Out1 Sel:		2
Opto Out2 Sel:		1
Min/Max:		0/29
Display:		1

Terminal Block Group *(continued)*

t070 [Opto Out1 Level]
t073 [Opto Out2 Level]

Related Parameter(s): [t069](#), [t072](#)

 32 bit parameter.

(PF 525) PowerFlex 525 only.

Determines the on/off point for the digital outputs when [t069](#) or [t072](#) [Opto Outx Sel] is set to the values shown below.

Min/Max Value Range Based On [Opto Outx Sel] Setting				
6: 0...500 Hz	10: 0...100%	16: 0.1...9999 s	20: 0/1	
7: 0...180%	11 0/1	17: 1...9999 counts	26: 0...150%	
8: 0...815V	13 0...800	18: 0...180°	-	

Values	Default:	0
	Min/Max:	0/9999
	Display:	1

t075 [Opto Out Logic]

(PF 525) PowerFlex 525 only.

Determines the logic (Normally Open/NO or Normally Closed/NC) of the digital outputs only.

Setting	Digital Out 1 Logic	Digital Out 2 Logic
0	NO	NO
1	NC	NO
2	NO	NC
3	NC	NC

Values	Default:	0
	Min/Max:	0/3
	Display:	1

Terminal Block Group (continued)

t076 [Relay Out1 Sel]

Related Parameter(s): [P046](#), [P048](#), [P050](#), [t070](#), [t073](#), [t077](#), [t082](#), [t086](#), [t087](#), [t093](#), [t094](#), [t097](#), [A541](#), [A564](#)

t081 [Relay Out2 Sel]

[PF 525] PowerFlex 525 only.

Determines the operation of the programmable output relay.

Options	Output Relay Changes State When...	Hysteresis
0 "Ready/Fault"	Relay changes state when power is applied. Indicates that the drive is ready for operation. Relay returns drive to shelf state when power is removed or a fault occurs.	None
1 "At Frequency"	Drive reaches commanded frequency.	0.5 Hz above; 1.0 Hz below
2 "MotorRunning"	Motor is receiving power from the drive.	None
3 "Reverse"	Drive is commanded to run in reverse direction.	None
4 "Motor Overld"	Motor overload condition exists.	100 ms time delay on or off
5 "Ramp Reg"	Ramp regulator is modifying the programmed accel/ decel times to avoid an overcurrent or overvoltage fault from occurring.	100 ms time delay on or off
6 "Above Freq"	Drive exceeds the frequency (Hz) value set in t077 or t082 [Relay Outx Level].	100 ms time delay on or off
7 "Above Cur"	Drive exceeds the current (% Amps) value set in t077 or t082 [Relay Outx Level]. IMPORTANT Value for t077 or t082 [Relay Outx Level] must be entered in percent of drive rated output current.	100 ms time delay on or off
8 "Above DCVolt"	Drive exceeds the DC bus voltage value set in t077 or t082 [Relay Outx Level].	100 ms time delay on or off
9 "Retries Exst"	Value set in A541 [Auto Rstrt Tries] is exceeded.	None
10 "Above Anlg V"	Analog input voltage (0-10V input) exceeds the value set in t077 or t082 [Relay Outx Level]. IMPORTANT Do not use if t093 [10V Bipolar Enbl] is set to 1 "Bi-Polar In".	100 ms time delay on or off
11 "Above PF Ang"	Power Factor angle exceeds the value set in t077 or t082 [Relay Outx Level].	100 ms time delay on or off
12 "Anlg In Loss"	Analog input loss has occurred. Program t094 [Anlg In V Loss] or t097 [Anlg In mA Loss] for desired action when input loss occurs.	On, 2 mA / ±1V Off, 3 mA / ±1.5V
13 "ParamControl"	Output will be directly controlled by the state of the t077 or t082 [Relay Outx Level]. A value of 0 causes the output to turn off. A value of 1 or greater in this parameter causes the output to turn on.	None
14 "NonRec Fault"	<ul style="list-style-type: none"> Value set in A541 [Auto Rstrt Tries] is exceeded or A541 [Auto Rstrt Tries] is not enabled or A non-resettable fault has occurred. 	None
15 "EM Brk Cntrl"	EM Brake is energized. Program t087 [EM Brk On Delay] and t086 [EM Brk Off Delay] for desired action.	None
16 "Thermal OL"	Relay energizes when thermal Motor overload counter is above the value set in t077 or t082 [Relay Outx Level]. It also energizes if the drive is within 5°C of the drive overheat trip point.	None
17 "Amb OverTemp"	Relay energizes when control module over temperature occurs.	None
18 "Local Active"	Active when drive P046 , P048 or P050 [Start Source x] is in local keypad control.	None
19 "Comm Loss"	Active when communication is lost from any comm source with reference or control.	None
20 "Logic In 1" ⁽¹⁾	An input is programmed as "Logic Input 1" and is active.	None
21 "Logic In 2" ⁽¹⁾	An input is programmed as "Logic Input 2" and is active.	None
22 "Logic 1 & 2" ⁽¹⁾	Both Logic inputs are programmed and active.	None
23 "Logic 1 or 2" ⁽¹⁾	One or both Logic inputs are programmed and one or both is active.	None
24 "StpLogic Out" ⁽¹⁾	Drive enters StepLogic step with Command Word set to enable Logic output.	None
25 "Timer Out"	Timer has reached the value set in t077 or t082 [Relay Outx Level] or not timing.	None
26 "Counter Out"	Counter has reached the value set in t077 or t082 [Relay Outx Level] or not counting.	None
27 "At Position" ⁽¹⁾	Drive is in Positioning mode and has reached the commanded position. Tolerance is adjusted with A564 [Encoder Pos Tol].	–
28 "At Home" ⁽¹⁾	Drive is in Positioning mode and has reached the home position. Tolerance is adjusted with A564 [Encoder Pos Tol].	–
29 "Safe-Off" ⁽¹⁾	Both safe-off inputs are active.	–

Values	Default:
Relay Out1 Sel:	0
Relay Out2 Sel:	2
Min/Max:	0/29
Display:	1

(1) Setting is specific to PowerFlex 525 drives only.

Terminal Block Group (continued)

t077 [Relay Out1 Level]

Related Parameter(s): [t076](#), [t081](#)

t082 [Relay Out2 Level]
 [PF 525] PowerFlex 525 only.

∇_{32} 32 bit parameter.

Determines the on/off point for the output relay when [t076](#) or [t081](#) [Relay Outx Sel] is set to the values shown below.

Min/Max Value Range Based On [Relay Outx Sel] Setting			
6:	0...500 Hz	10:	0...100%
16:	0.1...9999 s	20:	0/1
7:	0...180%	11:	0/1
17:	1...9999 counts	26:	0...150%
8:	0...815V	13:	0...800
18:	0...180°		–

Values	Default:	0
	Min/Max:	0/9999
	Display:	1

t079 [Relay 1 On Time]

t084 [Relay 2 On Time]
 [PF 525] PowerFlex 525 only.

Sets the delay time before Relay energizes after required condition is met.

Values	Default:	0.0 s
	Min/Max:	0.0/600.0 s
	Display:	0.1 s

t080 [Relay 1 Off Time]

t085 [Relay 2 Off Time]
 [PF 525] PowerFlex 525 only.

Sets the delay time before Relay de-energizes after required condition ceases.

Values	Default:	0.0 s
	Min/Max:	0.0/600.0 s
	Display:	0.1 s

t086 [EM Brk Off Delay]

Related Parameter(s): [P045](#)

Sets the time the drive remains at minimum frequency before ramping up to the commanded frequency (and engaging the brake coil relay) if Electromechanical (EM) Brake Control Mode is enabled with [P045](#) [Stop Mode].

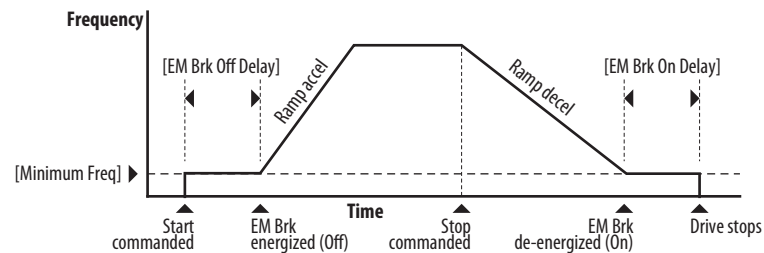

Values	Default:	2.00 s
	Min/Max:	0.00/10.00 s
	Display:	0.01 s

Terminal Block Group (continued)

t087 [EM Brk On Delay]

Related Parameter(s): [P045](#)

Sets the time the drive remains at minimum frequency (after releasing the brake coil relay) before stopping if EM Brake Control Mode is enabled with [P045](#) [Stop Mode].

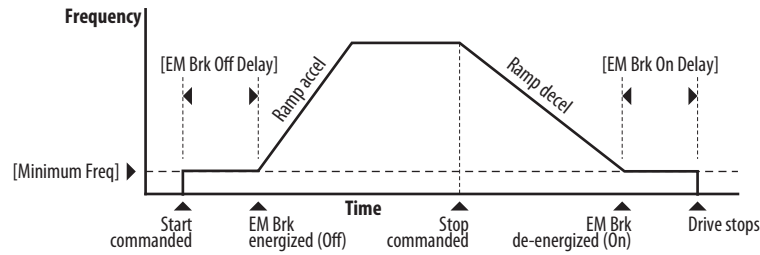

Values	Default:	2.00 s
	Min/Max:	0.00/10.00 s
	Display:	0.01 s

t088 [Analog Out Sel]

Related Parameter(s): [t090](#)

[PF 525] PowerFlex 525 only.

The 0-10V, 0-20 mA or 4-20 mA analog output can be used to provide a signal proportional to several drive conditions. This parameter also selects which analog calibration parameters to use.

Options	Output Range	Minimum Output Value	Maximum Output Value = t089 [Analog Out High]	Filter ⁽¹⁾	Related Parameter
0 "OutFreq 0-10"	0-10V	0V = 0 Hz	[Maximum Freq]	None	b001
1 "OutCurr 0-10"	0-10V	0V = 0 A	200% Drive Rated Current	Filter A	b003
2 "OutVolt 0-10"	0-10V	0V = 0 V	120% Drive Rated Output Volts	None	b004
3 "OutPowr 0-10"	0-10V	0V = 0 kW	200% Drive Rated Power	Filter A	b017
4 "OutTorq 0-10"	0-10V	0V = 0 A	200% Drive Rated Current	Filter A	d382
5 "TstData 0-10"	0-10V	0V = 0000	65535 (Hex FFFF)	None	–
6 "Setpnt 0-10"	0-10V	0V = 0%	100.0% Setpoint setting	None	t090
7 "DCVolt 0-10"	0-10V	0V = 0V	100.0% of trip value	None	b005
8 "OutFreq 0-20"	0-20 mA	0 mA = 0 Hz	[Maximum Freq]	None	b001
9 "OutCurr 0-20"	0-20 mA	0 mA = 0 A	200% Drive Rated Current	Filter A	b003
10 "OutVolt 0-20"	0-20 mA	0 mA = 0 V	120% Drive Rated Output Volts	None	b004
11 "OutPowr 0-20"	0-20 mA	0 mA = 0 kW	200% Drive Rated Power	Filter A	b017
12 "OutTorq 0-20"	0-20 mA	0 mA = 0 A	200% Drive Rated Current	Filter A	d382
13 "TstData 0-20"	0-20 mA	0 mA = 0000	65535 (Hex FFFF)	None	–
14 "Setpnt 0-20"	0-20 mA	0 mA = 0%	100.0% Setpoint setting	None	t090
15 "DCVolt 0-20"	0-20 mA	0 mA = 0V	100.0% of trip value	None	b005
16 "OutFreq 4-20"	4-20 mA	4 mA = 0 Hz	[Maximum Freq]	None	b001
17 "OutCurr 4-20"	4-20 mA	4 mA = 0 A	200% Drive Rated Current	Filter A	b003
18 "OutVolt 4-20"	4-20 mA	4 mA = 0 V	120% Drive Rated Output Volts	None	b004
19 "OutPowr 4-20"	4-20 mA	4 mA = 0 kW	200% Drive Rated Power	Filter A	b017
20 "OutTorq 4-20"	4-20 mA	4 mA = 0 A	200% Drive Rated Current	Filter A	d382
21 "TstData 4-20"	4-20 mA	4 mA = 0000	65535 (Hex FFFF)	None	–
22 "Setpnt 4-20"	4-20 mA	4 mA = 0%	100.0% Setpoint setting	None	t090
23 "DCVolt 4-20"	4-20 mA	4 mA = 0V	100.0% of trip value	None	b005

(1) Filter A is a single pole digital filter with a 162 ms time constant. Given a 0...100% step input from a steady state, the output of Filter A takes 500 ms to get to 95% of maximum, 810 ms to get to 99%, and 910 ms to get to 100%.

Values	Default:	0
	Min/Max:	0/23
	Display:	1

Terminal Block Group *(continued)*

t089 [Analog Out High]

(PF 525) PowerFlex 525 only.

Scales the maximum output value (V or mA) when the source setting is at maximum.

Values	Default:	100%
	Min/Max:	0/800%
	Display:	1%

t090 [Anlg Out Setpt]

Related Parameter(s): [t088](#)

(PF 525) PowerFlex 525 only.

Sets the percentage of output desired when [t088](#) [Analog Out Sel] is set to 6, 14 or 22 “Analog Setpoint”.

Values	Default:	0.0%
	Min/Max:	0.0/100.0%
	Display:	0.1%

t091 [Anlg In 0-10V Lo]

Related Parameter(s): [P043](#), [t092](#), [t093](#)

 Stop drive before changing this parameter.

Sets the percentage (based on 10V) of input voltage applied to the 0-10V analog input used to represent [P043](#) [Minimum Freq].

Analog inversion can be accomplished by setting this value larger than [t092](#) [Anlg In 0-10V Hi].

If [t093](#) [10V Bipolar Enbl] is set to 1 “Bi-Polar In”, this parameter is ignored.

Values	Default:	0.0%
	Min/Max:	0.0/200.0%
	Display:	0.1%

t092 [Anlg In 0-10V Hi]

Related Parameter(s): [P044](#), [t091](#), [t093](#)

 Stop drive before changing this parameter.

Sets the percentage (based on 10V) of input voltage applied to the 0-10V analog input used to represent [P044](#) [Maximum Freq].

Analog inversion can be accomplished by setting this value smaller than [t091](#) [Anlg In 0-10V Lo].

If [t093](#) [10V Bipolar Enbl] is set to 1 “Bi-Polar In”, the same value applies to positive and negative voltage.

Values	Default:	100.0%
	Min/Max:	0.0/200.0%
	Display:	0.1%

t093 [10V Bipolar Enbl]

Related Parameter(s): [t091](#), [t092](#)

(PF 525) PowerFlex 525 only.

Enables/disables bi-polar control. In bi-polar mode direction is commanded by the polarity of the voltage.

If bi-polar control is enabled, [P043](#) [Minimum Freq] and [t091](#) [Anlg In 0-10V Lo] are ignored.

Options	0	“Uni-Polar In” (Default)	0-10V only
	1	“Bi-Polar In”	±10V

Terminal Block Group *(continued)***t094 [Anlg In V Loss]**Related Parameter(s): [P043](#), [P044](#), [A426](#), [A427](#)

Sets the response to a loss of input. When the 0-10V input (or -10 to +10V) is used for any reference, any input less than 1V is reported as a signal loss. Input must exceed 1.5V for the signal loss condition to end.

If enabled, this function affects any input that is being used as a speed reference, PID reference or PID setpoint in the drive.

Options	0	"Disabled" (Default)
	1	"Fault (F29)"
	2	"Stop"
	3	"Zero Ref"
	4	"Min Freq Ref"
	5	"Max Freq Ref"
	6	"Key Freq Ref"
	7	"MOP Freq Ref"
	8	"Continu Last"

t095 [Anlg In4-20mA Lo]Related Parameter(s): [P043](#), [t096](#)

 Stop drive before changing this parameter.

Sets the percentage (based on 4-20 mA) of input current applied to the 4-20 mA analog input used to represent [P043](#) [Minimum Freq]. Analog inversion can be accomplished by setting this value larger than [t096](#) [Anlg In4-20mA Hi].

Values	Default:	0.0%
	Min/Max:	0.0/100.0%
	Display:	0.1%

t096 [Anlg In4-20mA Hi]Related Parameter(s): [P044](#), [t095](#)

 Stop drive before changing this parameter.

Sets the percentage (based on 4-20 mA) of input current applied to the 4-20 mA analog input used to represent [P044](#) [Maximum Freq]. Analog inversion can be accomplished by setting this value smaller than [t095](#) [Anlg In4-20mA Lo].

Values	Default:	100.0%
	Min/Max:	0.0/200.0%
	Display:	0.1%

t097 [Anlg In mA Loss]Related Parameter(s): [P043](#), [P044](#), [A426](#), [A427](#)

Sets the response to a loss of input. When the 4-20mA input is used for any reference, any input less than 2 mA is reported as a signal loss. Input must exceed 3 mA for the signal loss condition to end.

If enabled, this function affects any input that is being used as a speed reference or PID reference or PID setpoint in the drive.

Options	0	"Disabled" (Default)
	1	"Fault (F29)"
	2	"Stop"
	3	"Zero Ref"
	4	"Min Freq Ref"
	5	"Max Freq Ref"
	6	"Key Freq Ref"
	7	"MOP Freq Ref"
	8	"Continu Last"

Terminal Block Group (continued)

t098 [Anlg Loss Delay]Related Parameter(s): [t094](#), [t097](#)

Sets the length of time after power-up during which the drive detects no analog signal loss. Response to an analog signal loss is set in [t094](#) or [t097](#) [Analog In x Loss].

Values	Default:	0.0 s
	Min/Max:	0.0 /20.0 s
	Display:	0.1 s

t099 [Analog In Filter]

Sets the level of additional filtering of the analog input signals. A higher number increases filtering and decreases bandwidth. Each setting doubles the applied filtering (1 = 2x filter, 2 = 4x filter, and so on).

Values	Default:	0
	Min/Max:	0/14
	Display:	1

t100 [Sleep-Wake Sel]Related Parameter(s): [t101](#), [t102](#), [t103](#)

Drive “sleeps” if the appropriate analog input drops below the set [t101](#) [Sleep Level] for the time set in [t102](#) [Sleep Time] and the drive is running. When entering sleep mode the drive ramps to zero and the run indicator on the keypad display flashes to indicate the drive is in “sleep” mode.

When the appropriate analog input rises above the set [Wake Level], the drive “wakes” and ramps to the commanded frequency.

Inversion can be accomplished by setting [Sleep Level] to a higher setting than [t103](#) [Wake Level].



ATTENTION: Enabling the Sleep-Wake function can cause unexpected machine operation during the Wake mode. Equipment damage and/or personal injury can result if this parameter is used in an inappropriate application. In addition, all applicable local, national and international codes, standards, regulations or industry guidelines must be considered.

Options	0	“Disabled” (Default)
	1	“0-10V Input” Sleep enabled from 0-10V Analog Input 1
	2	“4-20mA Input” Sleep enabled from 4-20 mA Analog Input 2
	3	“Command Freq” Sleep enabled based on drive commanded frequency

t101 [Sleep Level]

Sets the analog input level the drive must reach to enter sleep mode.

Values	Default:	10.0%
	Min/Max:	0.0/100.0%
	Display:	0.1%

t102 [Sleep Time]

Sets the analog input time the drive must stay below to enter sleep mode.

Values	Default:	0.0 s
	Min/Max:	0.0/600.0 s
	Display:	0.1 s

t103 [Wake Level]

Sets the analog input level the drive must reach to wake from sleep mode.

Values	Default:	15.0%
	Min/Max:	0.0/100.0%
	Display:	0.1%

Terminal Block Group *(continued)***t104 [Wake Time]**

Sets the analog input time the drive must stay above to wake from sleep mode.

Values	Default:	0.0 s
	Min/Max:	0.0/600.0 s
	Display:	0.1 s

t105 [Safety Open En]

PF 525 PowerFlex 525 only.

Sets the action when both safety inputs (Safety 1 and Safety 2) are disabled (de-energized – no power is applied).

Options	0	"FaultEnable" (Default)
	1	"FaultDisable"

Communications Group

C121 [Comm Write Mode]

Saves parameter values in active drive memory (RAM) or in drive non-volatile memory (EEPROM).



ATTENTION: If Automatic Drive Configuration (ADC) is used, this parameter must remain at its default value of 0 "Save".

IMPORTANT Parameter values set prior to setting 1 "RAM only" are saved in RAM.

Options	0 "Save" (Default)
	1 "RAM only"

C122 [Cmd Stat Select]

[PF 525] PowerFlex 525 only.

Selects velocity-specific or position/fibers-specific Command and Status Word bit definitions for use over a communication network. See [Writing \(06\) Logic Command Data on page 191](#) for more information. This parameter cannot be changed when an I/O connection is established through the communication adapter or the drive's embedded EtherNet/IP port.

Options	0 "Velocity" (Default)
	1 "Position"

C123 [RS485 Data Rate]

Sets the communications baud rate (bits/second) for the RS485 port. A reset or power cycle is required after selection is made.

Options	0 "1200"
	1 "2400"
	2 "4800"
	3 "9600" (Default)
	4 "19,200"
	5 "38,400"

C124 [RS485 Node Addr]

Sets the Modbus drive node number (address) for the RS485 port if using a network connection. A reset or power cycle is required after selection is made.

Values	Default:	100
	Min/Max:	1/247
	Display:	1

C125 [Comm Loss Action]

Related Parameter(s): [P045](#)

Sets the drive's response to a loss of connection or excessive communication errors on the RS485 port.

Options	0 "Fault" (Default)	
	1 "Coast Stop"	Stops drive using "Coast to stop".
	2 "Stop"	Stops drive using P045 [Stop Mode] setting.
	3 "Continu Last"	Drive continues operating at communication commanded speed saved in RAM.

C126 [Comm Loss Time]

Related Parameter(s): [C125](#)

Sets the time that the drive remains in communication loss with the RS485 port before taking the action specified in [C125](#) [Comm Loss Action]. See [Appendix C](#) for more information.

IMPORTANT This setting is effective only if I/O that controls the drive is transmitted through the RS485 port.

Values	Default:	5.0 s
	Min/Max:	0.1/60.0 s
	Display:	0.1 s

Communications Group *(continued)*

C127 [RS485 Format]

Determines the details related to the specific Modbus protocol used by the drive. A reset or power cycle is required after selection is made.

Options	0	"RTU 8-N-1" (Default)
	1	"RTU 8-E-1"
	2	"RTU 8-O-1"
	3	"RTU 8-N-2"
	4	"RTU 8-E-2"
	5	"RTU 8-O-2"

C128 [EN Addr Sel]

Related Parameter(s): [C129-C132](#), [C133-C136](#), [C137-C140](#)

(PF 525) PowerFlex 525 only.

Enables the IP address, subnet mask and gateway address to be set with a BOOTP server. Identifies the connections that would be attempted on a reset or power cycle. A reset or power cycle is required after selection is made.

Options	1	"Parameters"
	2	"BOOTP" (Default)

C129 [EN IP Addr Cfg 1]

Related Parameter(s): [C128](#)

C130 [EN IP Addr Cfg 2]

C131 [EN IP Addr Cfg 3]

C132 [EN IP Addr Cfg 4]

(PF 525) PowerFlex 525 only.

Sets the bytes in the IP address. A reset or power cycle is required after selection is made.

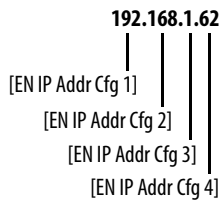

IMPORTANT C128 [EN Addr Sel] must be set to 1 "Parameters".

Values	Default:	0
	Min/Max:	0/255
	Display:	1

Communications Group *(continued)*

- C133** [EN Subnet Cfg 1]
- C134** [EN Subnet Cfg 2]
- C135** [EN Subnet Cfg 3]
- C136** [EN Subnet Cfg 4]

Related Parameter(s): [C128](#)

[PF 525] PowerFlex 525 only.

Sets the bytes of the subnet mask. A reset or power cycle is required after selection is made.

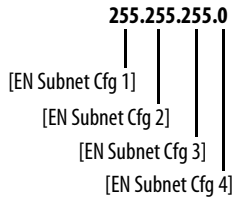

IMPORTANT C128 [EN Addr Sel] must be set to 1 "Parameters".

Values	Default:	0
	Min/Max:	0/255
	Display:	1

- C137** [EN Gateway Cfg 1]
- C138** [EN Gateway Cfg 2]
- C139** [EN Gateway Cfg 3]
- C140** [EN Gateway Cfg 4]

Related Parameter(s): [C128](#)

[PF 525] PowerFlex 525 only.

Sets the bytes of the gateway address. A reset or power cycle is required after selection is made.

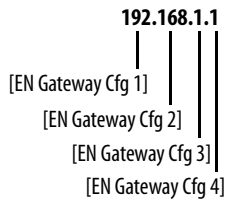

IMPORTANT C128 [EN Addr Sel] must be set to 1 "Parameters".

Values	Default:	0
	Min/Max:	0/255
	Display:	1

C141 [EN Rate Cfg]

[PF 525] PowerFlex 525 only.

Sets the network data rate at which EtherNet/IP communicates. A reset or power cycle is required after selection is made.

Options	0	"Auto detect" (Default)
	1	"10Mbps Full"
	2	"10Mbps Half"
	3	"100Mbps Full"
	4	"100Mbps Half"

Communications Group *(continued)***C143 [EN Comm Flt Actn]**Related Parameter(s): [P045](#), [C145](#), [C146](#), [C147-C150](#) PowerFlex 525 only.

Sets the action that the EtherNet/IP interface and drive takes if the EtherNet/IP interface detects that Ethernet communications have been disrupted.

IMPORTANT This setting is effective only if I/O that controls the drive is transmitted through the EtherNet/IP interface.**ATTENTION:** Risk of injury or equipment damage exists. Parameter C143 [EN Comm Flt Actn] lets you determine the action of the EtherNet/IP interface and connected drive if communications are disrupted. By default, this parameter faults the drive. You can set this parameter so that the drive continues to run. Precautions should be taken to ensure that the setting of this parameter does not create a risk of injury or equipment damage. When commissioning the drive, verify that your system responds correctly to various situations (for example, a disconnected drive).

Options	0	"Fault" (Default)
	1	"Stop" Drive stops per P045 [Stop Mode] setting.
	2	"Zero Data" Note: The Reference and Datalink values transmitted to the drive will be set to "0".
	3	"Hold Last" Note: The Logic Command, Reference, and Datalink values transmitted to the drive will be held at their last value.
	4	"Send Flt Cfg" Note: The Logic Command, Reference, and Datalink values will be transmitted to the drive as configured in C145, C146, and C147...C150.

C144 [EN Idle Flt Actn]Related Parameter(s): [P045](#), [C145](#), [C146](#), [C147-C150](#) PowerFlex 525 only.

Sets the action that the EtherNet/IP interface and drive takes if the EtherNet/IP interface detects that the scanner is idle because the controller was switched to program mode.

**ATTENTION:** Risk of injury or equipment damage exists. Parameter C144 [EN Idle Flt Actn] lets you determine the action of the EtherNet/IP interface and connected drive if the scanner is idle. By default, this parameter faults the drive. you can set this parameter so that the drive continues to run. Precautions should be taken to ensure that the setting of this parameter does not create a risk of injury or equipment damage. When commissioning the drive, verify that your system responds correctly to various situations (for example, a disconnected drive).

Options	0	"Fault" (Default)
	1	"Stop" Drive stops per P045 [Stop Mode] setting.
	2	"Zero Data" Note: The Reference and Datalink values transmitted to the drive will be set to "0".
	3	"Hold Last" Note: The Logic Command, Reference, and Datalink values transmitted to the drive will be held at their last value.
	4	"Send Flt Cfg" Note: The Logic Command, Reference, and Datalink values will be transmitted to the drive as configured in C145, C146, and C147...C150.

C145 [EN Flt Cfg Logic]Related Parameter(s): [C143](#), [C144](#) 32 bit parameter. PowerFlex 525 only.

Sets the Logic Command data that is sent to the drive if any of the following is true:

- [C143](#) [EN Comm Flt Actn] is set to 4 "Send Flt Cfg" and communications are disrupted.
- [C144](#) [EN Idle Flt Actn] is set to 4 "Send Flt Cfg" and the scanner is put into Program or Test mode.

See [Writing \(06\) Logic Command Data on page 191](#) for more information.

Values	Default:	0000
	Min/Max:	0000/FFFF
	Display:	0000

Communications Group *(continued)*

Related Parameter(s): [C143](#), [C144](#)

C146 [EN Flt Cfg Ref]

 32 bit parameter.

 PowerFlex 525 only.

Sets the Reference data that is sent to the drive if any of the following is true:

- [C143](#) [EN Comm Flt Actn] is set to 4 "Send Flt Cfg" and communications are disrupted.
- [C144](#) [EN Idle Flt Actn] is set to 4 "Send Flt Cfg" and the scanner is put into Program or Test mode.

Values	Default:	0
	Min/Max:	0/50000
	Display:	1

C147 [EN Flt Cfg DL 1]

C148 [EN Flt Cfg DL 2]

C149 [EN Flt Cfg DL 3]

C150 [EN Flt Cfg DL 4]

 PowerFlex 525 only.

Sets the Ethernet Datalink Input data that is sent to the drive if any of the following is true:

- [C143](#) [EN Comm Flt Actn] is set to 4 "Send Flt Cfg" and communications are disrupted.
- [C144](#) [EN Idle Flt Actn] is set to 4 "Send Flt Cfg" and the scanner is put into Program or Test mode.

Values	Default:	0
	Min/Max:	0/65535
	Display:	1

C153 [EN Data In 1]

C154 [EN Data In 2]

C155 [EN Data In 3]

C156 [EN Data In 4]

 PowerFlex 525 only.

Datalink parameter number whose value is written from the embedded EtherNet/IP data table. This parameter cannot be changed when an I/O connection is established through the drive's embedded EtherNet/IP port.

Values	Default:	0
	Min/Max:	0/800
	Display:	1

C157 [EN Data Out 1]

C158 [EN Data Out 2]

C159 [EN Data Out 3]

C160 [EN Data Out 4]

 PowerFlex 525 only.

Datalink parameter number whose value is read from the embedded EtherNet/IP data table. This parameter cannot be changed when an I/O connection is established through the drive's embedded EtherNet/IP port.

Values	Default:	0
	Min/Max:	0/800
	Display:	1

Communications Group *(continued)*

- C161 [Opt Data In 1]**
- C162 [Opt Data In 2]**
- C163 [Opt Data In 3]**
- C164 [Opt Data In 4]**

Datalink parameter number whose value is written from the High Speed Drive Serial Interface (HSDSI) data table. This parameter cannot be changed when an I/O connection is established through the communication adapter.

Values	Default:	0
	Min/Max:	0/800
	Display:	1

- C165 [Opt Data Out 1]**
- C166 [Opt Data Out 2]**
- C167 [Opt Data Out 3]**
- C168 [Opt Data Out 4]**

Datalink parameter number whose value is read from the HSDSI data table. This parameter cannot be changed when an I/O connection is established through the communication adapter.

Values	Default:	0
	Min/Max:	0/800
	Display:	1

C169 [MultiDrv Sel]

Sets the configuration of the drive that is in multi-drive mode. A reset or power cycle is required after selection is made.

Options	0 "Disabled" (Default)	No multi-drive master from the internal network option module or embedded Ethernet port. The drive can still function as a multi-drive slave or as a single drive (no multi-drive used).
	1 "Network Opt"	Multi-drive is enabled with the internal network option as a multi-drive master. The host drive is "Drive 0" and up to four slave drives can be daisy-chained from its RS485 port.
	2 "EtherNet/IP" ⁽¹⁾	Multi-drive is enabled with the embedded Ethernet port as the multi-drive master. The host drive is "Drive 0" and up to four slave drives can be daisy-chained from its RS485 port.

(1) Setting is specific to PowerFlex 525 drives only.

- C171 [Drv 1 Addr]**
- C172 [Drv 2 Addr]**
- C173 [Drv 3 Addr]**
- C174 [Drv 4 Addr]**

Related Parameter(s): [C169](#)

Sets the corresponding node addresses of the daisy-chained drives when [C169 \[MultiDrv Sel\]](#) is set to 1 "Network Opt" or 2 "EtherNet/IP". A reset or power cycle is required after selection is made.

Values	Default:	
	Drv 1 Addr:	2
	Drv 2 Addr:	3
	Drv 3 Addr:	4
	Drv 4 Addr:	5
Min/Max:	1/247	
Display:	1	

C175 [DSI I/O Cfg]

Sets the configuration of the Drives that are active in the multi-drive mode. Identifies the connections that would be attempted on a reset or power cycle. A reset or power cycle is required after selection is made.

Options	0 "Drive 0" (Default)
	1 "Drive 0-1"
	2 "Drive 0-2"
	3 "Drive 0-3"
	4 "Drive 0-4"

Logic Group

L180 [Stp Logic 0] L181 [Stp Logic 1]
 L182 [Stp Logic 2] L183 [Stp Logic 3]
 L184 [Stp Logic 4] L185 [Stp Logic 5]
 L186 [Stp Logic 6] L187 [Stp Logic 7]

Related Parameter(s):

 Stop drive before changing this parameter.

[PF 525] PowerFlex 525 only.

Values	Default:	00F1
	Min/Max:	0000/FAFF
	Display	0001

See [Appendix D](#) and [Appendix E](#) for more information on applying Step Logic and Position StepLogic.

Parameters L180...L187 are only active if [P047](#), [P049](#), or [P051](#) [Speed Reference] is set to 13 “Step Logic” or 16 “Positioning”. These parameters can be used to create a custom profile of frequency commands. Each “step” can be based on time, status of a Logic input or a combination of time and the status of a Logic input.

Digits 1...4 for each [Stp Logic x] parameter must be programmed according to the desired profile. A Logic input is established by setting a digital input, parameters [t062](#), [t063](#), [t065](#)...[t068](#) [DigIn TermBlk xx] to 24 “Logic In 1” and/or 25 “Logic In 2” or by using Bits 6 and 7 of [A560](#) [Enh Control Word].

A time interval between steps can be programmed using parameters [L190](#)...[L197](#) [Stp Logic Time x]. See the table below for related parameters.

The speed for any step is programmed using parameters [A410](#)...[A417](#) [Preset Freq x].

Step	StepLogic Parameter	Related Preset Frequency Parameter (Can be activated independent of StepLogic Parameters)	Related StepLogic Time Parameter (Active when L180...L187 Digit 1 or 2 are set to 1, b, C, d or E)
0	L180 [Stp Logic 0]	A410 [Preset Freq 0]	L190 [Stp Logic Time 0]
1	L181 [Stp Logic 1]	A411 [Preset Freq 1]	L191 [Stp Logic Time 1]
2	L182 [Stp Logic 2]	A412 [Preset Freq 2]	L192 [Stp Logic Time 2]
3	L183 [Stp Logic 3]	A413 [Preset Freq 3]	L193 [Stp Logic Time 3]
4	L184 [Stp Logic 4]	A414 [Preset Freq 4]	L194 [Stp Logic Time 4]
5	L185 [Stp Logic 5]	A415 [Preset Freq 5]	L195 [Stp Logic Time 5]
6	L186 [Stp Logic 6]	A416 [Preset Freq 6]	L196 [Stp Logic Time 6]
7	L187 [Stp Logic 7]	A417 [Preset Freq 7]	L197 [Stp Logic Time 7]

The position for any step is programmed using parameters [L200](#)...[L214](#) [Step Units x].

Step	StepLogic Position Parameter
0	L200 [Step Units 0] & L201 [Step Units F 0]
1	L202 [Step Units 1] & L203 [Step Units F 1]
2	L204 [Step Units 2] & L205 [Step Units F 2]
3	L206 [Step Units 3] & L207 [Step Units F 3]
4	L208 [Step Units 4] & L209 [Step Units F 4]
5	L210 [Step Units 5] & L211 [Step Units F 5]
6	L212 [Step Units 6] & L213 [Step Units F 6]
7	L214 [Step Units 7] & L215 [Step Units F 7]

How StepLogic Works

The StepLogic sequence begins with a valid start command. A normal sequence always begins with L180 [Stp Logic 0].

Digit 1: Logic for next step

This digit defines the logic for the next step. When the condition is met the program advances to the next step. Step 0 follows Step 7. Example: Digit 1 is set to 3. When “Logic In 2” becomes active, the program advances to the next step.

Digit 2: Logic to jump to a different step

For all settings other than F, when the condition is met, the program overrides Digit 0 and jumps to the step defined by Digit 3.

Digit 3: Different step to jump

When the condition for Digit 2 is met, this digit setting determines the next step or to end the program.

Digit 4: Step settings

This digit defines additional characteristics of each step.

Any StepLogic parameter can be programmed to control a relay or opto output, but you can not control different outputs based on the condition of different StepLogic commands.

StepLogic Settings

The logic for each function is determined by the four digits for each StepLogic parameter. The following is a listing of the available settings for each digit. See [Appendix D](#) for more information.

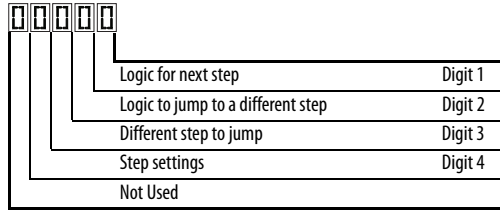

Velocity Control Settings (Digit 4)

Required Setting	Accel/Decel Param. Used	StepLogic Output State	Commanded Direction
0	Accel/Decel 1	Off	FWD
1	Accel/Decel 1	Off	REV
2	Accel/Decel 1	Off	No Output
3	Accel/Decel 1	On	FWD
4	Accel/Decel 1	On	REV
5	Accel/Decel 1	On	No Output
6	Accel/Decel 2	Off	FWD
7	Accel/Decel 2	Off	REV
8	Accel/Decel 2	Off	No Output
9	Accel/Decel 2	On	FWD
A	Accel/Decel 2	On	REV
b	Accel/Decel 2	On	No Output

Positioning Settings (Digit 4)

Required Setting	Accel/Decel Param. Used	StepLogic Output State	Direction From Home	Type of Command
0	Accel/Decel 1	Off	FWD	Absolute
1	Accel/Decel 1	Off	FWD	Incremental
2	Accel/Decel 1	Off	REV	Absolute
3	Accel/Decel 1	Off	REV	Incremental
4	Accel/Decel 1	On	FWD	Absolute
5	Accel/Decel 1	On	FWD	Incremental
6	Accel/Decel 1	On	REV	Absolute
7	Accel/Decel 1	On	REV	Incremental
8	Accel/Decel 2	Off	FWD	Absolute
9	Accel/Decel 2	Off	FWD	Incremental
A	Accel/Decel 2	Off	REV	Absolute
b	Accel/Decel 2	Off	REV	Incremental
C	Accel/Decel 2	On	FWD	Absolute
d	Accel/Decel 2	On	FWD	Incremental
E	Accel/Decel 2	On	REV	Absolute
F	Accel/Decel 2	On	REV	Incremental

Settings (Digit 3)

Setting	Description
0	Jump to Step 0
1	Jump to Step 1
2	Jump to Step 2
3	Jump to Step 3
4	Jump to Step 4
5	Jump to Step 5
6	Jump to Step 6
7	Jump to Step 7
8	End Program (Normal Stop)
9	End Program (Coast to Stop)
A	End Program and Fault (F2)

Settings (Digit 2 and 1)

Setting	Description
0	Skip Step (Jump Immediately)
1	Step Based on [Stp Logic Time x]
2	Step if "Logic In 1" is Active
3	Step if "Logic In 2" is Active
4	Step if "Logic In 1" is Not Active
5	Step if "Logic In 2" is Not Active
6	Step if either "Logic In 1" or "Logic In 2" is Active
7	Step if both "Logic In 1" and "Logic In 2" are Active
8	Step if neither "Logic In 1" nor "Logic In 2" is Active
9	Step if "Logic In 1" is Active and "Logic In 2" is Not Active
A	Step if "Logic In 2" is Active and "Logic In 1" is Not Active
b	Step after [Stp Logic Time x] and "Logic In 1" is Active
C	Step after [Stp Logic Time x] and "Logic In 2" is Active
d	Step after [Stp Logic Time x] and "Logic In 1" is Not Active
E	Step after [Stp Logic Time x] and "Logic In 2" is Not Active
F	Do Not Step/Ignore Digit 2 Settings

Logic Group *(continued)*

- L190 [Stp Logic Time 0] L191 [Stp Logic Time 1]
- L192 [Stp Logic Time 2] L193 [Stp Logic Time 3]
- L194 [Stp Logic Time 4] L195 [Stp Logic Time 5]
- L196 [Stp Logic Time 6] L197 [Stp Logic Time 7]

 PowerFlex 525 only.

Sets the time to remain in each step if the corresponding command word is set to "Step based on time".

Values	Default:	30.0 s
	Min/Max:	0.0/999.9 s
	Display:	0.1 s

- L200 [Step Units 0] L202 [Step Units 1]
- L204 [Step Units 2] L206 [Step Units 3]
- L208 [Step Units 4] L210 [Step Units 5]
- L212 [Step Units 6] L214 [Step Units 7]

 32 bit parameter.

 PowerFlex 525 only.

Sets the position in user-defined units the drive must reach at each step.

Values	Default:	0
	Min/Max:	0/6400
	Display:	1

Advanced Display Group

d360 [Analog In 0-10V]

 Related Parameter(s): [t091](#), [t092](#)

Displays the 0-10V analog input as a percent of full scale.

Values	Default:	Read Only
	Min/Max:	0.0/100.0%
	Display:	0.1%

d361 [Analog In 4-20mA]

 Related Parameter(s): [t095](#), [t096](#)

Displays the 4-20 mA analog input as a percent of full scale.

Values	Default:	Read Only
	Min/Max:	0.0/100.0%
	Display:	0.1%

d362 [Elapsed Time-hr]

 Related Parameter(s): [A555](#)

Displays the total elapsed powered-up time (in hours) since timer reset. The timer stops when it reaches the maximum value.

Values	Default:	Read Only
	Min/Max:	0/32767 hr
	Display:	1 hr

d363 [Elapsed Time-min]

 Related Parameter(s): [d362](#), [A555](#)

 Displays the total elapsed powered-up time (in minutes) since timer reset. Resets to zero when maximum value is reached and increments [d362](#) [Elapsed Time-hr] by one.

Values	Default:	Read Only
	Min/Max:	0.0/60.0 min
	Display:	0.1 min

d364 [Counter Status]

Displays the current value of the counter if enabled.

Values	Default:	Read Only
	Min/Max:	0/65535
	Display:	1

d365 [Timer Status]

 32 bit parameter.

Displays the current value of the timer if enabled.

Values	Default:	Read Only
	Min/Max:	0/9999 s
	Display:	1 s

d367 [Drive Type]

Used by Rockwell Automation field service personnel.

Values	Default:	Read Only
	Min/Max:	0/65535
	Display:	1

Advanced Display Group (continued)

d368 [Testpoint Data]

Related Parameter(s): [A483](#)

Displays the present value of the function selected in [A483](#) [Testpoint Sel].

Values	Default:	Read Only
	Min/Max:	0/FFFF
	Display:	1

d369 [Motor OL Level]

Displays the motor overload counter.

Values	Default:	Read Only
	Min/Max:	0.0/150.0%
	Display:	0.1%

d375 [Slip Hz Meter]

Related Parameter(s): [P032](#)

Displays the current amount of slip or droop (absolute value) being applied to the motor frequency. Drives applies slip based on the setting for [P032](#) [Motor NP Hertz].

Values	Default:	Read Only
	Min/Max:	0.0/25.0 Hz
	Display:	0.1 Hz

d376 [Speed Feedback]

 32 bit parameter.

Displays the value of the actual motor speed whether measured by encoder/pulse train feedback or estimated.

Values	Default:	Read Only
	Min/Max:	0/64000 rpm
	Display:	1 rpm

d378 [Encoder Speed]

 32 bit parameter.

 PowerFlex 525 only.

Provides a monitoring point that reflects the speed measured from the feedback device. This shows the encoder or pulse train speed even if not used directly to control motor speed.

Values	Default:	Read Only
	Min/Max:	0/64000 rpm
	Display:	1 rpm

d380 [DC Bus Ripple]

Displays the real-time value of the DC bus ripple voltage.

Values	Default:	Read Only
	Min/Max:	0/410VDC for 230V AC drives; 820VDC for 460VAC drives; 1025VDC for 600VAC drives
	Display:	1V DC

d381 [Output Powr Fctr]

Displays the angle in electrical degrees between motor voltage and motor current.

Values	Default:	Read Only
	Min/Max:	0.0/180.0 deg
	Display:	0.1 deg

Advanced Display Group *(continued)*

d382 [Torque Current]

Displays the current value of the motor torque current measured by the drive.

Values	Default:	Read Only
	Min/Max:	0.00/(Drive Rated Amps x 2)
	Display:	0.01 A

d383 [PID1 Fdbk Displ]

d385 [PID2 Fdbk Displ]

(PF 525) PowerFlex 525 only.

Displays the active PID Feedback value.

Values	Default:	Read Only
	Min/Max:	0.0/100.0%
	Display:	0.1%

d384 [PID1 Setpnt Displ]

d386 [PID2 Setpnt Displ]

(PF 525) PowerFlex 525 only.

Displays the active PID Setpoint value.

Values	Default:	Read Only
	Min/Max:	0.0/100.0%
	Display:	0.1%

d387 [Position Status]

(PF 525) PowerFlex 525 only.

Displays the present operating condition of the drive. When in Positioning mode, Bit 1 indicates positive or negative position in relation to Home.

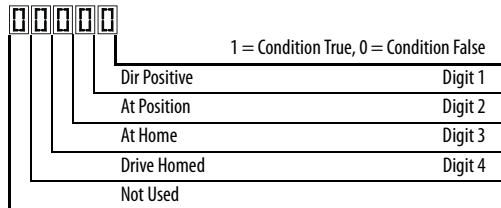

Values	Default:	Read Only
	Min/Max:	0000/1111
	Display:	0000

d388 [Units Traveled H]

Related Parameter(s): [d387](#)



Stop drive before changing this parameter.

32 bit parameter.

(PF 525) PowerFlex 525 only.

Displays the number of user-defined units traveled from the home position. See [d387](#) [Position Status] for direction of travel.

Values	Default:	Read Only
	Min/Max:	0/64000
	Display:	1

Advanced Display Group *(continued)*

d389 [Units Traveled L]

Related Parameter(s): [d387](#)

 Stop drive before changing this parameter.

 PowerFlex 525 only.

Displays the number of user-defined units traveled from the home position. See [d387](#) [Position Status] for direction of travel.

Values	Default:	Read Only
	Min/Max:	0.00/0.99
	Display:	0.01

d390 [Fiber Status]

Present status of the Fibers features.

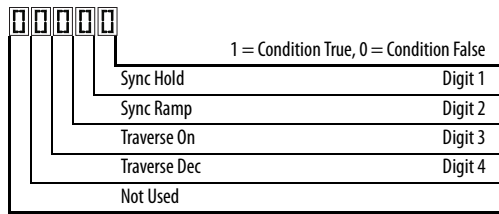

Values	Default:	Read Only
	Min/Max:	0000/1111
	Display:	0000

d391 [Stp Logic Status]

Related Parameter(s): [P047](#), [L180-L187](#)

 32 bit parameter.

 PowerFlex 525 only.

Displays the current step of the Step Logic profile as defined by parameters [L180...L187](#) [Step Logic x] when [P047](#) [Speed Reference1] is set to 13 “Step Logic” or 16 “Positioning”.

Values	Default:	Read Only
	Min/Max:	0/8
	Display:	1

d392 [RdyBit Mode Act]

Related Parameter(s): [A574](#)

 PowerFlex 525 only.

(With FRN 3.xxx and later.)

Displays the value of [A574](#) [RdyBit Mode Cfg].

Values	Default:	Read Only
	Min/Max:	0/1
	Display:	1

Advanced Program Group

A410 [Preset Freq 0] A411 [Preset Freq 1]
 A412 [Preset Freq 2] A413 [Preset Freq 3]
 A414 [Preset Freq 4] A415 [Preset Freq 5]
 A416 [Preset Freq 6] A417 [Preset Freq 7]

A418 [Preset Freq 8] A419 [Preset Freq 9]
 A420 [Preset Freq 10] A421 [Preset Freq 11]
 A422 [Preset Freq 12] A423 [Preset Freq 13]
 A424 [Preset Freq 14] A425 [Preset Freq 15]

[PF 525] PowerFlex 525 only.

Sets the frequency of the drive outputs to the programmed value when selected.

For PowerFlex 525					
	Default Accel/Decel Used	Preset Input 1 (DigIn TermBlk 05)	Preset Input 2 (DigIn TermBlk 06)	Preset Input 3 (DigIn TermBlk 07)	Preset Input 4 (DigIn TermBlk 08)
Preset Setting 0 ⁽¹⁾	1	0	0	0	0
Preset Setting 1	1	1	0	0	0
Preset Setting 2	2	0	1	0	0
Preset Setting 3	2	1	1	0	0
Preset Setting 4	1	0	0	1	0
Preset Setting 5	1	1	0	1	0
Preset Setting 6	2	0	1	1	0
Preset Setting 7	2	1	1	1	0
Preset Setting 8	1	0	0	0	1
Preset Setting 9	1	1	0	0	1
Preset Setting 10	2	0	1	0	1
Preset Setting 11	2	1	1	0	1
Preset Setting 12	1	0	0	1	1
Preset Setting 13	1	1	0	1	1
Preset Setting 14	2	0	1	1	1
Preset Setting 15	2	1	1	1	1

For PowerFlex 523					
	Default Accel/Decel Used	Preset Input 1 (DigIn TermBlk 05)	Preset Input 2 (DigIn TermBlk 06)	Preset Input 3 (DigIn TermBlk 03)	–
Preset Setting 0 ⁽¹⁾	1	0	0	0	
Preset Setting 1	1	1	0	0	
Preset Setting 2	2	0	1	0	
Preset Setting 3	2	1	1	0	
Preset Setting 4	1	0	0	1	
Preset Setting 5	1	1	0	1	
Preset Setting 6	2	0	1	1	
Preset Setting 7	2	1	1	1	

(1) Preset Setting 0 is only available if P047, P049 or P051 [Speed Referencex] is set to 7 "Preset Freq".

Values	Defaults:
	Preset Freq 0: 0.00 Hz
	Preset Freq 1: 5.00 Hz
	Preset Freq 2: 10.00 HZ
	Preset Freq 3: 20.00 Hz
	Preset Freq 4: 30.00 Hz
	Preset Freq 5: 40.00 Hz
	Preset Freq 6: 50.00 Hz
	Preset Freq 7...15: 60.00 Hz
	Min/Max: 0.00/500.00 Hz
	Display: 0.01 Hz

Advanced Program Group *(continued)*

A426 [Keypad Freq]

Related Parameter(s): [P047](#), [P049](#), [P051](#)

Provides the drive frequency command using the built-in keypad navigation. When [P047](#), [P049](#) or [P051](#) [Speed Reference] selects 2 "Keypad Freq", the value set in this parameter controls the frequency of the drive. The value of this parameter can also be changed when navigating with the keypad by pressing the Up or Down arrow keys.

Values	Default:	60.00 Hz
	Min/Max:	0.00/500.00 Hz
	Display:	0.01 Hz

A427 [MOP Freq]

Provides the drive frequency command using the built-in Motor Operated Potentiometer (MOP).

IMPORTANT

Frequency is not written to non-volatile storage until drive is powered-down. If both MOP Up and MOP Down are applied at the same time, the inputs are ignored and the frequency is unchanged.

Values	Default:	60.00 Hz
	Min/Max:	0.00/500.00 Hz
	Display:	0.01 Hz

A428 [MOP Reset Sel]

Determines if the current MOP reference command is saved on power down.

Options	0 "Zero MOP Ref"	Resets the MOP frequency to zero on power down and stop.
	1 "Save MOP Ref" (Default)	

A429 [MOP Preload]

Determines the operation of the MOP function.

Options	0 "No preload" (Default)	
	1 "Preload"	Bumpless Transfer: whenever MOP mode is selected, the current output value of the speed is loaded.

A430 [MOP Time]

Sets the rate of change of the MOP reference.

Values	Default:	10.0 s
	Min/Max:	0.1/600.0 s
	Display:	0.1 s

A431 [Jog Frequency]

Related Parameter(s): [P044](#)

Sets the output frequency when a jog command is issued.

Values	Default:	10.00 Hz
	Min/Max:	0.00/[Maximum Freq]
	Display:	0.01 Hz

A432 [Jog Accel/Decel]

Sets the acceleration and deceleration time used when in jog mode.

Values	Default:	10.00 s
	Min/Max:	0.01/600.00 s
	Display:	0.01 s

Advanced Program Group *(continued)*

A433 [Purge Frequency]

Related Parameter(s): [t062](#), [t063](#), [t065-t068](#)

Provides a fixed frequency command value when [t062](#), [t063](#), [t065-t068](#) [DigIn TermBlk xx] is set to 40 "Purge".

Values	Default:	5.00 Hz
	Min/Max:	0.00/500.00 Hz
	Display:	0.01 Hz

A434 [DC Brake Time]

Related Parameter(s): [P045](#), [A435](#)

Sets the length of time that DC brake current is "injected" into the motor.

Values	Default:	0.0 s
	Min/Max:	0.0/99.9 s
	Display:	0.1 s

A435 [DC Brake Level]

Related Parameter(s): [P045](#)

Defines the maximum DC brake current, in amps, applied to the motor when [P045](#) [Stop Mode] is set to either 4 "Ramp" or 6 "DC Brake".

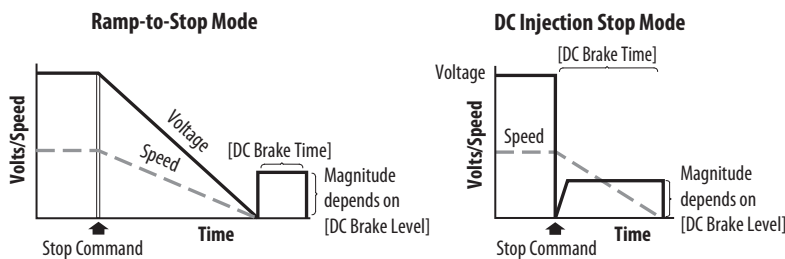

ATTENTION: If a hazard of injury due to movement of equipment or material exists, an auxiliary mechanical braking device must be used. This feature should not be used with synchronous motors. Motors may be demagnetized during braking.

Values	Default:	Drive Rated Amps x 0.05
	Min/Max:	0.00/(Drive Rated Amps x 1.80)
	Display:	0.01 A

A436 [DC Brk Time@Strt]

Related Parameter(s): [P045](#), [A435](#)

Sets the length of time that DC brake current is "injected" into the motor after a valid start command is received.

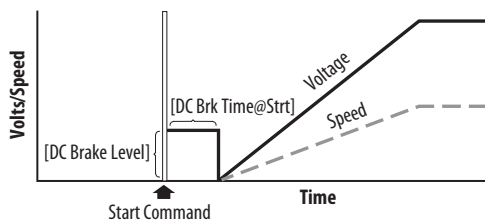

Values	Default:	0.0 s
	Min/Max:	0.0/99.9 s
	Display:	0.1 s

Advanced Program Group (continued)

A437 [DB Resistor Sel]

 Stop drive before changing this parameter.

Enables/disables external dynamic braking and selects the level of resistor protection.

Options	0	"Disabled" (Default)	
	1	"Norml RA Res"	5%
	2	"NoProtection"	100%
	3...99	"3...99% DutyCycle"	

A438 [DB Threshold]

Related Parameter(s): [A437](#)

Sets the DC bus voltage threshold for Dynamic Brake operation. If DC bus voltage rises above this level, Dynamic Brake turns on. Lower values makes the dynamic braking function more responsive but may result in nuisance Dynamic Brake activation.



ATTENTION: Equipment damage may result if this parameter is set to a value that causes the dynamic braking resistor to dissipate excessive power. Parameter settings less than 100% should be carefully evaluated to ensure that the Dynamic Brake resistor's wattage rating is not exceeded. In general, values less than 90% are not needed. This parameter's setting is especially important if parameter A437 [DB Resistor Sel] is set to 2 "NoProtection".

Values	Default:	100.0%
	Min/Max:	10.0/110.0%
	Display:	0.1%

A439 [S Curve %]

Enables a fixed shape S-Curve that is applied to the acceleration and deceleration ramps (including jog).

$S\text{-Curve Time} = (\text{Accel or Decel Time}) \times (\text{S-Curve Setting in percentage})$

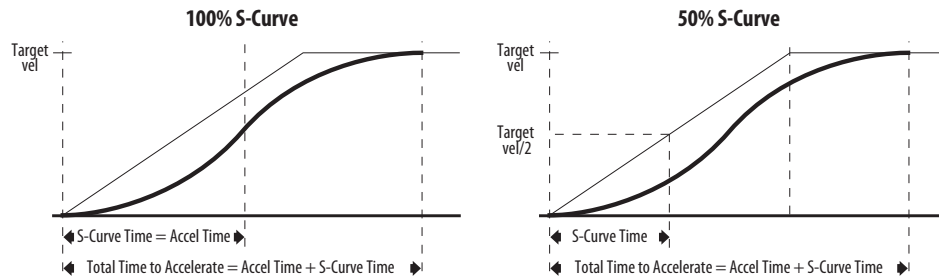

Example:

Accel Time = 10 s
 S-Curve Setting = 30%
 $S\text{-Curve Time} = 10 \times 0.3 = 3 \text{ s}$

Values	Default:	0%
	Min/Max:	0/100%
	Display:	1%

Advanced Program Group *(continued)*

A440 [PWM Frequency]

Related Parameter(s): [A540](#)

Sets the carrier frequency for the PWM output waveform. The chart below provides derating guidelines based on the PWM frequency setting.

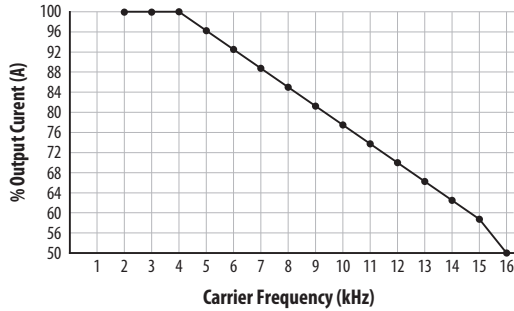

IMPORTANT

Ignoring derating guidelines can cause reduced drive performance. The drive may automatically reduce the PWM carrier frequency at low output speeds, unless prevented from doing so by A540 [Var PWM Disable].

Values	Default:	4.0 kHz
	Min/Max:	2.0/16.0 kHz
	Display:	0.1 kHz

A441 [Droop Hertz@ FLA]

(PF 525) PowerFlex 525 only.

Reduces the frequency based on current. This frequency is subtracted from the commanded output frequency. Generally Slip and Droop would not both be used, but if both are enabled they simply subtract from each other. Typically used in load sharing schemes.

Values	Default:	0.0 Hz
	Min/Max:	0.0/10.0 Hz
	Display:	0.1 Hz

A442 [Accel Time 2]

Related Parameter(s): [P044](#)

Time for the drive to ramp from 0.0 Hz to [P044](#) [Maximum Freq] if Accel Time 2 is selected.

$$\text{Accel Rate} = [\text{Maximum Freq}] / [\text{Accel Time}]$$

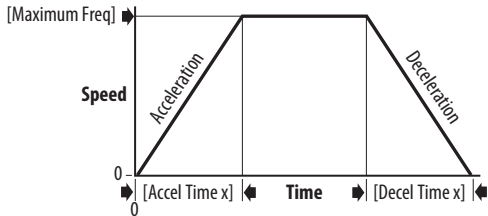

Values	Default:	10.00 s
	Min/Max:	0.00/600.00 s
	Display:	0.01 s

A443 [Decel Time 2]

Related Parameter(s): [P044](#)

Time for the drive to ramp from [P044](#) [Maximum Freq] to 0.0 Hz if Decel Time 2 is selected.

$$\text{Decel Rate} = [\text{Maximum Freq}] / [\text{Decel Time}]$$

Values	Default:	10.00 s
	Min/Max:	0.00/600.00 s
	Display:	0.01 s

Advanced Program Group *(continued)*

A444 [Accel Time 3]

A446 [Accel Time 4]

Sets the rate of acceleration for all speed increases when selected by digital inputs.

Values	Default:	10.00 s
	Min/Max:	0.00/600.00 s
	Display:	0.01 s

A445 [Decel Time 3]

A447 [Decel Time 4]

Sets the rate of deceleration for all speed decreases when selected by digital inputs.

Values	Default:	10.00 s
	Min/Max:	0.00/600.00 s
	Display:	0.01 s

A448 [Skip Frequency 1]

A450 [Skip Frequency 2]

Related Parameter(s): [A449](#), [A451](#), [A453](#), [A455](#)

A452 [Skip Frequency 3]

A454 [Skip Frequency 4]

(PF 525) PowerFlex 525 only.

Works in conjunction with [A449](#), [A451](#), [A453](#) and [A455](#) [Skip Freq Band x] creating a range of frequencies at which the drive does not operate continuously.

Values	Default:	0.0 Hz (Disabled)
	Min/Max:	0.0/500.0 Hz
	Display:	0.1 Hz

A449 [Skip Freq Band 1]

A451 [Skip Freq Band 2]

Related Parameter(s): [A448](#), [A450](#), [A452](#), [A454](#)

A453 [Skip Freq Band 3]

A455 [Skip Freq Band 4]

(PF 525) PowerFlex 525 only.

Determines the band around [A448](#), [A450](#), [A452](#) and [A454](#) [Skip Frequency x].

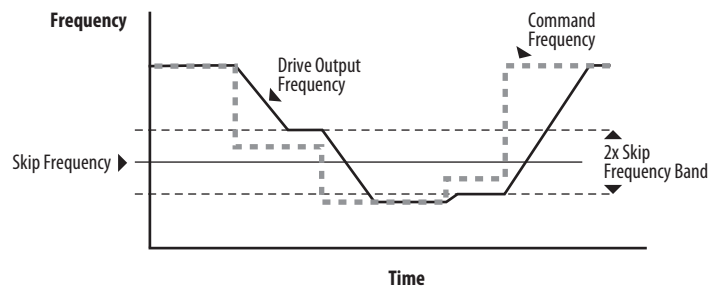

Values	Default:	0.0 Hz
	Min/Max:	0.0/30.0 Hz
	Display:	0.1 Hz

Advanced Program Group *(continued)*

A456 [PID 1 Trim Hi]

A468 [PID 2 Trim Hi]

 PowerFlex 525 only.

Scales the upper value of the trim frequency when trim is active.

Values	Default:	60.0 Hz
	Min/Max:	0.0/500.0 Hz
	Display:	0.1 Hz

A457 [PID 1 Trim Lo]

A469 [PID 2 Trim Lo]

 PowerFlex 525 only.

Scales the lower value of the trim frequency when trim is active.

Values	Default:	0.0 Hz
	Min/Max:	0.0/500.0 Hz
	Display:	0.1 Hz

A458 [PID 1 Trim Sel]

A470 [PID 2 Trim Sel]

 PowerFlex 525 only.



Stop drive before changing this parameter.

Sets the PID output as trim to the source reference.

Options	0 "Disabled" (Default)	PID Trim is disabled.
	1 "TrimOn Pot"	
	2 "TrimOn Keypd"	
	3 "TrimOn DSI"	
	4 "TrimOn NetOp"	
	5 "TrimOn 0-10V"	
	6 "TrimOn 4-20"	
	7 "TrimOn Prset"	
	8 "TrimOn AnMlt" ⁽¹⁾	
	9 "TrimOn MOP"	
	10 "TrimOn Pulse"	
	11 "TrimOn Slgic" ⁽¹⁾	
	12 "TrimOn Encdr" ⁽¹⁾	
	13 "TrimOn ENet" ⁽¹⁾	

(1) Setting is specific to PowerFlex 525 drives only.

Advanced Program Group *(continued)*

A459 [PID 1 Ref Sel]

A471 [PID 2 Ref Sel]

[PF 525] PowerFlex 525 only.

 Stop drive before changing this parameter.

Selects the source of the PID reference.

Options	0	"PID Setpoint" (Default)
	1	"Drive Pot"
	2	"Keypad Freq"
	3	"Serial/DSI"
	4	"Network Opt"
	5	"0-10V Input"
	6	"4-20mA Input"
	7	"Preset Freq"
	8	"AnIIn Multi" ⁽¹⁾
	9	"MOP Freq"
	10	"Pulse Input"
	11	"Step Logic" ⁽¹⁾
	12	"Encoder" ⁽¹⁾
	13	"EtherNet/IP" ⁽¹⁾

(1) Setting is specific to PowerFlex 525 drives only.

A460 [PID 1 Fdback Sel]

A472 [PID 2 Fdback Sel]

[PF 525] PowerFlex 525 only.

Selects the source of the PID feedback.

Options	0	"0-10V Input" (Default)	Note: PID does not function with bipolar input. Negative voltages are ignored and treated as zero.
	1	"4-20mA Input"	
	2	"Serial/DSI"	
	3	"Network Opt"	
	4	"Pulse Input"	
	5	"Encoder" ⁽¹⁾	
	6	"EtherNet/IP" ⁽¹⁾	

(1) Setting is specific to PowerFlex 525 drives only.

A461 [PID 1 Prop Gain]

Related Parameter(s): [A459](#), [A471](#)

A473 [PID 2 Prop Gain]

[PF 525] PowerFlex 525 only.

Sets the value for the PID proportional component when the PID mode is enabled.

Values	Default:	0.01
	Min/Max:	0.00/99.99
	Display:	0.01

Advanced Program Group *(continued)*

A462 [PID 1 Integ Time]

Related Parameter(s): [A459](#), [A471](#)

A474 [PID 2 Integ Time]

(PF 525) PowerFlex 525 only.

Sets the value for the PID integral component when PID mode is enabled.

Values	Default:	2.0 s
	Min/Max:	0.0/999.9 s
	Display:	0.1 s

A463 [PID 1 Diff Rate]

Related Parameter(s): [A459](#), [A471](#)

A475 [PID 2 Diff Rate]

(PF 525) PowerFlex 525 only.

Sets the value (in 1/second) for the PID differential component when PID mode is enabled.

Values	Default:	0.00
	Min/Max:	0.00/99.99
	Display:	0.01

A464 [PID 1 Setpoint]

Related Parameter(s): [A459](#), [A471](#)

A476 [PID 2 Setpoint]

(PF 525) PowerFlex 525 only.

Provides an internal fixed value for process setpoint when PID mode is enabled.

Values	Default:	0.0%
	Min/Max:	0.0/100.0%
	Display:	0.1%

A465 [PID 1 Deadband]

A477 [PID 2 Deadband]

(PF 525) PowerFlex 525 only.

Sets the lower limit of the PID output.

Values	Default:	0.0%
	Min/Max:	0.0/10.0%
	Display:	0.1%

A466 [PID 1 Preload]

A478 [PID 2 Preload]

(PF 525) PowerFlex 525 only.

Sets the value used to preload the integral component on start or enable.

Values	Default:	0.0 Hz
	Min/Max:	0.0/500.0 Hz
	Display:	0.1 Hz

A467 [PID 1 Invert Err]

A479 [PID 2 Invert Err]

(PF 525) PowerFlex 525 only.

Changes the sign of the PID error.

Options	0	"Normal" (Default)
	1	"Inverted"

Advanced Program Group *(continued)*

A481 [Process Disp Lo]

Related Parameter(s): [b010](#), [P043](#)

Sets the value displayed in [b010](#) [Process Display] when the drive is running at [P043](#) [Minimum Freq].

Values	Default:	0.00
	Min/Max:	0.00/99.99
	Display:	0.01

A482 [Process Disp Hi]

Related Parameter(s): [b010](#), [P044](#)

Sets the value displayed in [b010](#) [Process Display] when the drive is running at [P044](#) [Maximum Freq].

Values	Default:	0.00
	Min/Max:	0.00/99.99
	Display:	0.01

A483 [Testpoint Sel]

Used by Rockwell Automation field service personnel.

Values	Default:	400
	Min/Max:	0/FFFF
	Display:	1

A484 [Current Limit 1]

Related Parameter(s): [P033](#)

Maximum output current allowed before current limiting occurs.

Values	Default:	Drive Rated Amps x 1.1 (Normal Duty); Drive Rated Amps x 1.5 (Heavy Duty)
	Min/Max:	0.0/Drive Rated Amps x 1.5 (Normal Duty); Drive Rated Amps x 1.8 (Heavy Duty)
	Display:	0.1 A

A485 [Current Limit 2]

Related Parameter(s): [P033](#)

(PF 525) PowerFlex 525 only.

Maximum output current allowed before current limiting occurs.

Values	Default:	Drive Rated Amps x 1.1
	Min/Max:	0.0/Drive Rated Amps x 1.5 (Normal Duty); Drive Rated Amps x 1.8 (Heavy Duty)
	Display:	0.1 A

A486 [Shear Pin1 Level]

Related Parameter(s): [A487](#), [A489](#)

A488 [Shear Pin2 Level]

(PF 525) PowerFlex 525 only.

Sets the value of current at which the shear pin fault occurs after the time set in [A487](#), [A489](#) [Shear Pin x Time]. Setting the value at 0.0 A disables this function.

Values	Default:	0.0 A (Disabled)
	Min/Max:	0.0/(Drive Rated Amps x 2)
	Display:	0.1 A

A487 [Shear Pin 1 Time]

Related Parameter(s): [A486](#), [A488](#)

A489 [Shear Pin 2 Time]

(PF 525) PowerFlex 525 only.

Sets the continuous time the drive must be at or above the value set in [A486](#), [A488](#) [Shear Pinx Level] before a shear pin fault occurs.

Values	Default:	0.00 s
	Min/Max:	0.00/30.00 s
	Display:	0.01 s

Advanced Program Group *(continued)*

A490 [Load Loss Level]

Related Parameter(s): [A491](#)

(PF 525) PowerFlex 525 only.

Provides a software trip (Load Loss fault) when the current drops below this level for the time specified in [A491](#) [Load Loss Time].

Values	Default:	0.0 A
	Min/Max:	0.0/Drive Rated Amps
	Display:	0.1 A

A491 [Load Loss Time]

Related Parameter(s): [A490](#)

(PF 525) PowerFlex 525 only.

Sets the required time for the current to be below [A490](#) [Load Loss Level] before a Load Loss fault occurs.

Values	Default:	0 s
	Min/Max:	0/9999 s
	Display:	1 s

A492 [Stall Fault Time]

Sets the time that the drive remains in stall mode before a fault is issued.

Options	0 "60 Seconds" (Default)
	1 "120 Seconds"
	2 "240 Seconds"
	3 "360 Seconds"
	4 "480 Seconds"
	5 "Flt Disabled"

A493 [Motor OL Select]

Related Parameter(s): [P032](#), [P033](#)

Drive provides Class 10 overload protection. Settings 0...2 select the derating factor for the I^2t overload function.

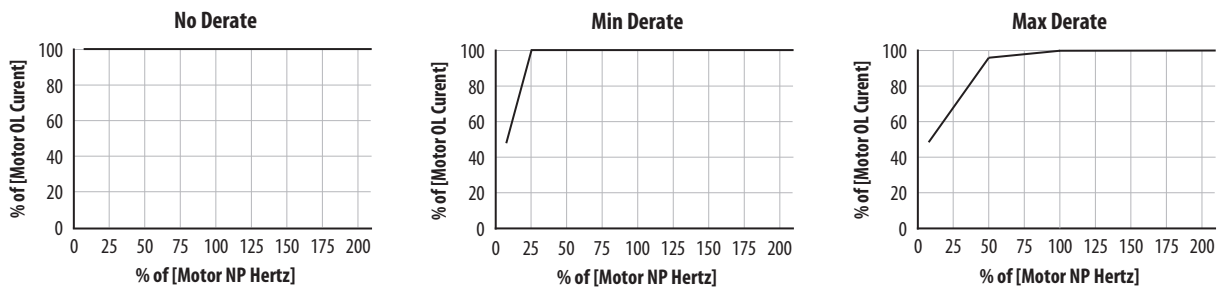

Options	0 "No Derate" (Default)
	1 "Min. Derate"
	2 "Max. Derate"

A494 [Motor OL Ret]

Selects whether the motor overload counter is saved on power-down or reset on power-up.

Options	0 "Reset" (Default)
	1 "Save"

Advanced Program Group *(continued)*

A495 [Drive OL Mode]

Determines how the drive handles overload conditions that would otherwise cause the drive to fault.

Options	0	"Disabled"
	1	"Reduce CLim"
	2	"Reduce PWM"
	3	"Both-PWM 1st" (Default)

A496 [IR Voltage Drop]

Related Parameter(s): [P040](#)

Value of volts dropped across the resistance of the motor stator (autotune) for induction motor.

Values	Default:	Based on Drive Rating
	Min/Max:	0.0/600.0VAC
	Display:	0.1VAC

A497 [Flux Current Ref]

Related Parameter(s): [P040](#)

This is the current necessary for full motor flux. The value should be set to the full speed no-load current of the motor.

Values	Default:	Based on Drive Rating
	Min/Max:	0.00/(Drive Rated Amps x 1.4)
	Display:	0.01 A

A498 [Motor Rr]

(PF 525) PowerFlex 525 only.

Rotor resistance of induction motor.

Values	Default:	Based on Drive Rating
	Min/Max:	0.00/655.35 ohm
	Display:	0.01 ohm

A499 [Motor Lm]

(PF 525) PowerFlex 525 only.

Mutual Inductance of induction motor.

Values	Default:	Based on Drive Rating
	Min/Max:	0.0/6553.5 mH
	Display:	0.1 mH

A500 [Motor Lx]

(PF 525) PowerFlex 525 only.

Leakage Inductance of induction motor.

Values	Default:	Based on Drive Rating
	Min/Max:	0.0/6553.5 mH
	Display:	0.1 mH

A509 [Speed Reg Sel]

Related Parameter(s): [A521](#), [A522](#), [A523](#), [A524](#), [A525](#), [A526](#)

(PF 525) PowerFlex 525 only.

Determines if PI gain of the "Vector" control mode speed regulator is set automatically or manually. Parameters [A521](#)...[A526](#) are set automatically by this parameter.

Options	0	"Automatic" (Default)
	1	"Manual"

Advanced Program Group *(continued)***A510 [Freq 1]****A512 [Freq 2]****A514 [Freq 3]**

(PF 525) PowerFlex 525 only.

Sets the “Vector” control mode frequency.

Values	Default:	
	Freq 1:	8.33%
	Freq 2:	15.00%
	Freq 3:	20.00%
	Min/Max:	0.00/200.00%
	Display:	0.01%

A511 [Freq 1 BW]**A513 [Freq 2 BW]****A515 [Freq 3 BW]**

(PF 525) PowerFlex 525 only.

Speed control loop bandwidth for “Vector” control mode.

Values	Default:	10 Hz
	Min/Max:	0/40 Hz
	Display:	1 Hz

A521 [Freq 1 Kp]

Related Parameter(s): [A509](#), [A510](#)

A523 [Freq 2 Kp]**A525 [Freq 3 Kp]**

(PF 525) PowerFlex 525 only.

Sets P-gain of “Vector” control mode when in frequency region 1, 2 or 3 for faster speed response during dynamic-state where motor is still accelerating. If [A509](#) [Speed Reg Sel] is set to 1 “Manual”, these parameters can be changed.

Values	Default:	100.0%
	Min/Max:	0.0/500.0%
	Display:	0.1%

A522 [Freq 1 Ki]

Related Parameter(s): [A509](#), [A510](#)

A524 [Freq 2 Ki]**A526 [Freq 3 Ki]**

(PF 525) PowerFlex 525 only.

Sets I-gain of “Vector” control mode when in frequency region 1, 2 or 3 for faster speed response during steady-state where motor is at its rated speed. If [A509](#) [Speed Reg Sel] is set to 1 “Manual”, these parameters can be changed.

Values	Default:	0.100 s
	Min/Max:	0.000/10.000 s
	Display:	0.001 s

Advanced Program Group (continued)

A530 [Boost Select]

Related Parameter(s): [b004](#), [P031](#), [P032](#), [P039](#)

Sets the boost voltage (% of [P031](#) [Motor NP Volts]) and redefines the V/Hz curve. Only used for V/Hz and SVC control modes.

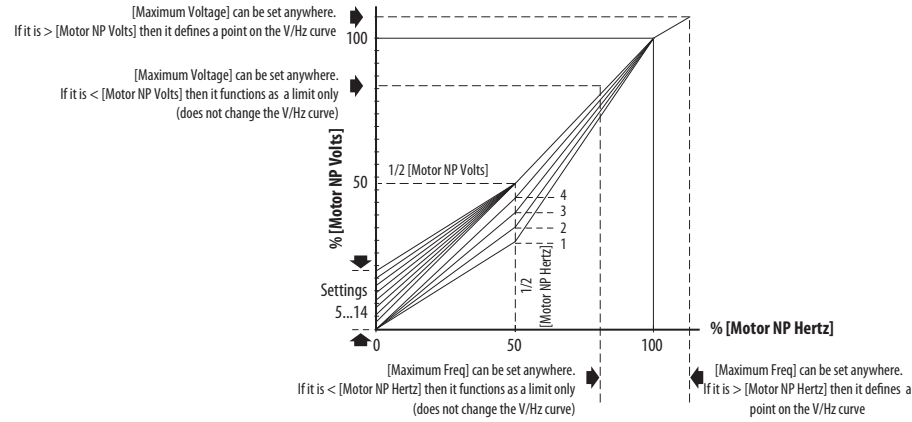

Options	0 "Custom V/Hz"	
	1 "30.0, VT"	
	2 "35.0, VT"	Fan/Pump Curves (Variable Torque)
	3 "40.0, VT"	
	4 "45.0, VT"	
	5 "0.0, no IR"	
	6 "0.0" (Default for 400V and 600V drives, 5 HP and above)	
	7 "2.5, CT" (Default for 200V drives, 5 HP and above)	
	8 "5.0, CT" (Default for drives below 5 HP)	Boost Voltage (% of Base) (Constant Torque)
	9 "7.5, CT"	
	10 "10.0, CT"	
	11 "12.5, CT"	
	12 "15.0, CT"	
	13 "17.5, CT"	
	14 "20.0, CT"	

Advanced Program Group *(continued)*

A531 [Start Boost]

Related Parameter(s): [P031](#), [P032](#), [P039](#), [A530](#)

Sets the boost voltage (% of [P031](#) [Motor NP Volts]) and redefines the V/Hz curve when [A530](#) [Boost Select] = 0 "Custom V/Hz" and [P039](#) [Torque Perf Mode] = 0 "V/Hz".

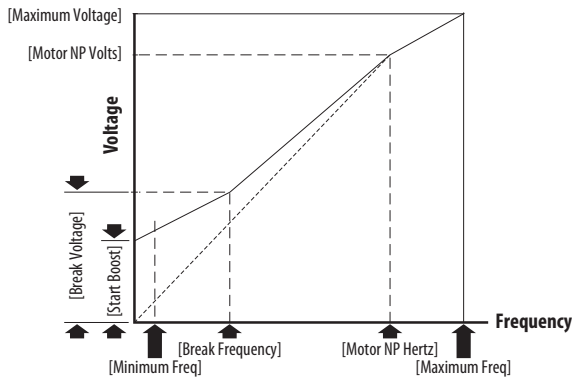

Values	Default:	2.5%
	Min/Max:	0.0/25.0%
	Display:	0.1%

A532 [Break Voltage]

Related Parameter(s): [P031](#), [P032](#), [P039](#), [A530](#), [A533](#)

Sets the voltage (in percent of [Base Frequency]) at the [A533](#) [Break Frequency] if [A530](#) [Boost Select] is set to 0 "Custom V/Hz".

Values	Default:	25.0%
	Min/Max:	0.0/100.0%
	Display:	0.1%

A533 [Break Frequency]

Related Parameter(s): [P031](#), [P032](#), [P039](#), [A530](#), [A532](#)

Sets the frequency where [A532](#) [Break Voltage] is applied if [A530](#) [Boost Select] is set to 0 "Custom V/Hz".

Values	Default:	15.0 Hz
	Min/Max:	0.0/500.0 Hz
	Display:	0.1 Hz

A534 [Maximum Voltage]

Related Parameter(s): [b004](#)

Sets the highest voltage the drive outputs.

Values	Default:	Drive Rated Volts
	Min:	10V AC (on 230V AC Drives); 20V AC (on 460V AC Drives); 25V AC (on 600V AC Drives)
	Max:	255V AC (on 230V AC Drives); 510V AC (on 460V AC Drives); 637.5V AC (on 600V AC Drives)
	Display:	1V AC

Advanced Program Group (continued)

A535 [Motor Fdbk Type]

Related Parameter(s): [A537](#)

 Stop drive before changing this parameter.

[PF 525] PowerFlex 525 only.

Selects the encoder type.



ATTENTION: The loss of analog input, encoder or other feedback may cause unintended speed or motion. Take appropriate precautions to guard against possible unintended speed or motion.

		Allowable Control Modes	Hardware Inputs
Options	0 "None" (Default)	For all motor types	–
	1 "Pulse Train"	All except Vector	[DigIn TermBlk 07]
	2 "Single Chan"	All except Vector	
	3 "Single Check"	All except Vector	
	4 "Quadrature"	For all motor types	Optional incremental encoder card (catalog number 25-ENC-1)
	5 "Quad Check"	For all motor types	

A536 [Encoder PPR]

[PF 525] PowerFlex 525 only.

Specifies the encoder Pulses Per Revolution (PPR) when an encoder is used.

Motor Control Mode	Recommended Minimum Encoder PPR
Sensorless Vector Control (SVC)	42 x (number of poles/2) [Speed range 100:1] : 84 PPR (4 pole motor)
Velocity Vector Control (VVC)	500 x (number of poles/2) [Speed range 1000:1] : 1000 PPR (4 pole motor)

The maximum encoder pulse is 250 kHz.

Values	Default:	1024 PPR
	Min/Max:	1/20000 PPR
	Display:	1 PPR

A537 [Pulse In Scale]

Related Parameter(s): [t065](#), [t067](#), [A535](#)

Sets the scale factor/gain for the Pulse Input when [t065](#) or [t067](#) [DigIn TermBlk xx] is set to 52 "Pulse Train", or [A535](#) [Motor Fdbk Type] is set to 1 "Pulse Train".

Input frequency (Hz) / Pulse in Scale = Output frequency (Hz)

Values	Default:	64
	Min/Max:	0/20000
	Display:	1

A538 [Ki Speed Loop]

[PF 525] PowerFlex 525 only.

Sets the I-gain used in the PI calculation of the speed loop when feedback is used.

Values	Default:	2.0
	Min/Max:	0.0/400.0
	Display:	0.1

A539 [Kp Speed Loop]

[PF 525] PowerFlex 525 only.

Sets the P-gain used in the PI calculation of the speed loop when feedback is used.

Values	Default:	5.0
	Min/Max:	0.0/200.0
	Display:	0.1

Advanced Program Group *(continued)***A540 [Var PWM Disable]**Related Parameter(s): [A440](#) Stop drive before changing this parameter.Enables/disables a feature that varies the carrier frequency for the PWM output waveform defined by [A440](#) [PWM Frequency].

Options	0	"Enabled" (Default)
	1	"Disabled"

A541 [Auto Rstrt Tries]Related Parameter(s): [A542](#)Sets the maximum number of times the drive attempts to reset a fault and restart. See [Chapter 4](#) for more information on faults and fault codes.**Clear a Type 1 fault and restart the drive.**

1. Set A541 [Auto Rstrt Tries] to a value other than "0".
2. Set [A542](#) [Auto Rstrt Delay] to a value other than "0".

Clear an OverVoltage, UnderVoltage or Heatsink OvrTmp fault without restarting the drive.

1. Set A541 [Auto Rstrt Tries] to a value other than "0".
2. Set [A542](#) [Auto Rstrt Delay] to "0".

**ATTENTION:** Equipment damage and/or personal injury may result if this parameter is used in an inappropriate application. Do not use this function without considering applicable local, national and international codes, standards, regulations or industry guidelines.

Values	Default:	0
	Min/Max:	0/9
	Display:	1

A542 [Auto Rstrt Delay]Related Parameter(s): [A541](#)Sets the time between restart attempts if [A541](#) [Auto Rstrt Tries] is not zero.

Values	Default:	1.0 s
	Min/Max:	0.0/120.0 s
	Display:	0.1 s

A543 [Start At PowerUp] Stop drive before changing this parameter.

Enables/disables drive start on power up without a Start command being cycled. Requires a digital input configured for Run or Start and a valid start contact.

**ATTENTION:** Equipment damage and/or personal injury may result if this parameter is used in an inappropriate application. Do not use this function without considering applicable local, national and international codes, standards, regulations or industry guidelines.

Options	0	"Disabled" (Default)
	1	"Enabled"

A544 [Reverse Disable]Related Parameter(s): [b006](#) Stop drive before changing this parameter.

Enables/disables the function that allows the direction of motor rotation to be changed.

Options	0	"Rev Enabled" (Default)
	1	"Rev Disabled"

A545 [Flying Start En]

Sets the condition that allows the drive to reconnect to a spinning motor at actual RPM.

Options	0	"Disabled" (Default)
	1	"Enabled" Catch and ramp to commanded speed at every drive start.

Advanced Program Group *(continued)*

A546 [FlyStrt CurLimit]

Used to determine when the drive has matched the motor frequency if flying start is enabled.

Values	Default:	150%
	Min/Max:	30/200%
	Display:	1%

A547 [Compensation]

Enables/disables correction options that may improve problems with motor instability.

Options	0 "Disabled"	No compensation.
	1 "Electrical" (Default)	Some drive/motor combinations have inherent instabilities which are exhibited as non-sinusoidal motor currents. This setting attempts to correct this condition
	2 "Mechanical"	Some motor/load combinations have mechanical resonances which can be excited by the drive current regulator. This setting slows down the current regulator response and attempts to correct this condition.
	3 "Both"	

A548 [Power Loss Mode]

Sets the reaction to a loss of input power.

Options	0 "Coast" (Default)	Drive faults and motor coasts to a stop.
	1 "Decel"	Drive decelerates and attempts to keep the DC bus voltage above the undervoltage level.

A549 [Half Bus Enable]

Enables/disables the power ride through function which allows the drive to maintain power to the motor at 50% drive input voltage during short-term power sag conditions.



ATTENTION: To guard against drive damage, a minimum line impedance must be provided to limit inrush current when the power line recovers. The input impedance should be equal or greater than the equivalent of a 5% transformer with a VA rating 6 times the drive's input VA rating if Half Bus is enabled.

Options	0 "Disabled" (Default)
	1 "Enabled"

A550 [Bus Reg Enable]

Enables/disables the bus regulator.

Options	0 "Disabled"
	1 "Enabled" (Default)

A551 [Fault Clear]



Stop drive before changing this parameter.

Resets a fault and clears the fault queue.

Options	0 "Ready/Idle" (Default)
	1 "Reset Fault" Resets the active fault but does not clear any fault buffer.
	2 "Clear Buffer" Resets the active fault and clears all fault buffers to "0".

A552 [Program Lock]

Related Parameter(s): [A553](#)

Protects parameters against change by unauthorized personnel with a 4-digit password.

Values	Default:	0000
	Min/Max:	0000/9999
	Display:	1111

Advanced Program Group *(continued)***A553 [Program Lock Mod]**Related Parameter(s): [A552](#)Determines the lock mode used in parameter [A552](#) [Program Lock]. When set to 2 or 3, A552 [Program Lock] is added to the custom group to allow unlocking of parameters.

Options	0	"Full Lock" (Default)	All parameters are locked except [Program Lock].
	1	"Keypad Lock"	All parameters are locked except [Program Lock] from keypad access but can still be accessed over communications.
	2	"Custom Only"	All parameters are locked and hidden except custom group and [Program Lock].
	3	"KeyPd Custom"	All parameters are locked and hidden except custom group and [Program Lock] from keypad access but can still be accessed over communications.

A554 [Drv Ambient Sel]

Sets the maximum expected ambient of the drive when used above 50 °C. When ambient temperature is above 50 °C, the drive will apply necessary current derating.

Options	0	"Normal" (Default)	
	1	"55C"	
	2	"60C"	
	3	"65C +Fan Kit"	Fan kit required.
	4	"70C +Fan Kit"	

A555 [Reset Meters]Related Parameter(s): [b019](#), [b021](#), [b022](#), [b023](#), [b024](#), [b025](#), [b026](#), [d362](#), [d363](#)

Resets the values stored in the parameters that track fault times and energy usage.

Options	0	"Ready/Idle" (Default)	
	1	"Reset Meters"	Resets kWh, MWh, Accum kWh, Cost, and CO2 Sav parameter values.
	2	"Reset Time"	Resets min, hr, and x10 hr.

A556 [Text Scroll]

Sets the scrolling speed of the text in the LCD display.

Options	0	"Off"	No scroll.
	1	"Low Speed"	
	2	"Mid Speed" (Default)	
	3	"High Speed"	

A557 [Out Phas Loss En]

Enable/disable output phase loss detection.

**ATTENTION:** Equipment damage and/or personal injury may result if this parameter is used in an inappropriate application. Do not use this function without considering applicable local, national and international codes, standards, regulations or industry guidelines.

Options	0	"Disable" (Default)	
	1	"Enable"	

A558 [Positioning Mode]
 Stop drive before changing this parameter.

(PF 525) PowerFlex 525 only.

Defines the positioning transition mode used for the position steps.

Options	0	"Time Steps" (Default)	Steps based on time.
	1	"Preset Input"	Preset inputs directly commands a given step.
	2	"Step Logic"	Use Step Logic Commands. Always start from Step 0.
	3	"Preset Stpl"	Use Preset Inputs to determine starting step then Step Logic commands.
	4	"StpLogic-Lst"	Use Step Logic commands from last Step Logic step at last drive stop.

Advanced Program Group *(continued)*

A559 [Counts Per Unit]

(PF 525) PowerFlex 525 only.

Sets the number of encoder counts equal to one user-defined unit.

Values	Default:	4096
	Min/Max:	1/32000
	Display:	1

A560 [Enh Control Word]

Related Parameter(s): [t062](#), [t063](#), [t065 - t068](#), [A571](#)

(PF 525) PowerFlex 525 only.

Allows control of positioning and other functions through parameter control for use over comms. The functions replicate the digital input options and function in the same way.

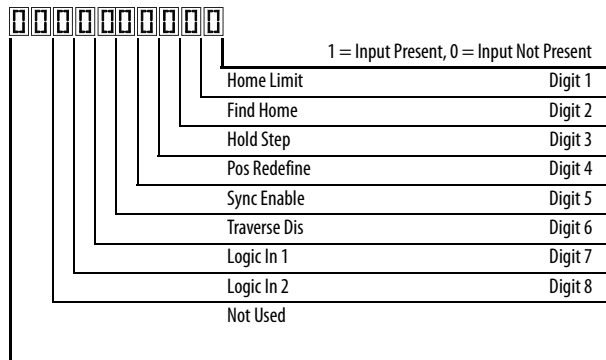

Values	Default:	0000 0000
	Min/Max:	0000 0000/1111 1111
	Display:	0000 0000

Digits	0	"Home Limit"	In Positioning mode, this indicates the drive is at the home position
	1	"Find Home"	When set, the next start command causes the drive to find home. Set this bit to 0 after completing the homing routine.
	2	"Hold Step"	In Positioning mode, this input over-rides other inputs and causes the drive to remain at its current step (running at zero speed once it reaches its position) until released.
	3	"Pos Redefine"	In Positioning mode, this input resets the home position to the current position of the machine. Set this bit to 0 after completing the homing routine.
	4	"Sync Enable"	Must be used in order to hold the existing frequency when Sync Time is set to enable speed synchronization. When this bit is reset to zero the drive accelerates to the new commanded frequency based on A571 [Sync Time] setting.
	5	"Traverse Dis"	When set the traverse function is disabled.
	6	"Logic In 1"	This provides an identical function as the "Logic In1" Digital Input option. This bit is logically ORed with a digital input t062 , t063 , t065-t068 [DigIn TermBlk xx] set to 24 "Logic In1". It can be used to move through the Step-Logic functions (speed or position) using comms control without requiring actual digital input transitions.
	7	"Logic In 2"	This provides an identical function as the "Logic In2" Digital Input option. This bit is logically ORed with a digital input t062 , t063 , t065-t068 [DigIn TermBlk xx] set to 25 "Logic In2". It can be used to move through the Step-Logic functions (speed or position) using comms control without requiring actual digital input transitions.

A561 [Home Save]

(PF 525) PowerFlex 525 only.

Determines whether the current position is saved on power down.

Options	0	"Home Reset" (Default)	Position resets to zero on power up.
	1	"Home Saved"	

Advanced Program Group *(continued)***A562 [Find Home Freq]** PowerFlex 525 only.

Sets the maximum frequency the drive uses when “Find Home” is issued.

Values	Default:	10.0 Hz
	Min/Max:	0.1/500.0 Hz
	Display:	0.1 Hz

A563 [Find Home Dir]

Stop drive before changing this parameter.

 PowerFlex 525 only.

Sets the direction the drive commands when “Find Home” is issued.

Options	0	“Forward” (Default)
	1	“Reverse”

A564 [Encoder Pos Tol] PowerFlex 525 only.

Sets the “At Position” and the “At Home” tolerance around the encoder count. The value is added to and subtracted from the target encoder unit value to create the tolerance range.

Values	Default:	100
	Min/Max:	1/50000
	Display:	1

A565 [Pos Reg Filter] PowerFlex 525 only.

Sets the error signal filter in the position regulator.

Values	Default:	8
	Min/Max:	0/15
	Display:	1

A566 [Pos Reg Gain] PowerFlex 525 only.

Sets the gain adjustment for the position regulator.

Values	Default:	3.0
	Min/Max:	0.0/200.0
	Display:	0.1

Advanced Program Group (continued)

A567 [Max Traverse]

Sets the amplitude of triangle wave speed modulation.

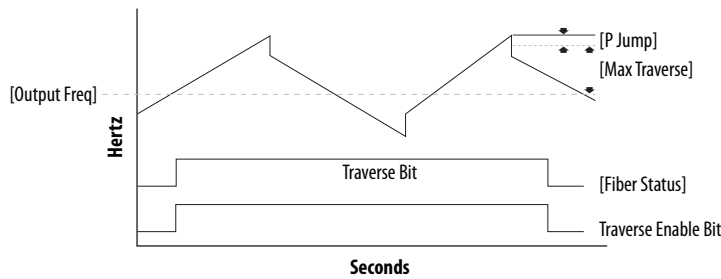

Values	Default:	0.00 Hz
	Min/Max:	0.00/300.00 Hz
	Display:	0.01 Hz

A568 [Traverse Inc]

Related Parameter(s): [A567](#)

Sets the time required for the Traverse function to accelerate from the minimum to the maximum traverse frequency. See the diagram at [A567](#) [Max Traverse].

Values	Default:	0.00 s
	Min/Max:	0.00/300.00 s
	Display:	0.01 s

A569 [Traverse Dec]

Related Parameter(s): [A567](#)

Sets the time required for the Traverse function to decelerate from the maximum to the minimum traverse frequency. See the diagram at [A567](#) [Max Traverse].

Values	Default:	0.00 s
	Min/Max:	0.00/300.00 s
	Display:	0.01 s

A570 [P Jump]

Related Parameter(s): [A567](#)

Sets the frequency amplitude that is added to or subtracted from the commanded frequency. See the diagram at [A567](#) [Max Traverse].

Values	Default:	0.00 Hz
	Min/Max:	0.00/300.00 Hz
	Display:	0.01 Hz

A571 [Sync Time]

Related Parameter(s): [t062](#), [t063](#), [t065 - t068](#), [A560](#)

Enables the function that holds the drive at the current frequency even if the commanded frequency changes. Used with [t062](#), [t063](#), [t065-t068](#) [DigIn TermBlk xx] 32 "Sync Enable".

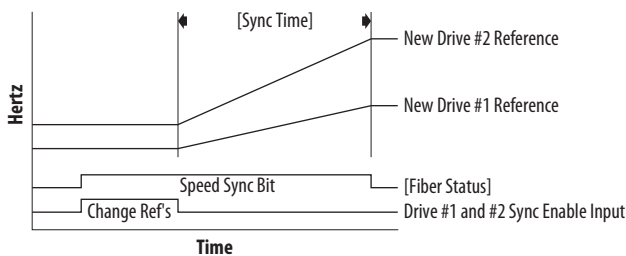

Values	Default:	0.0 s
	Min/Max:	0.0/3200.0 s
	Display:	0.1 s

Advanced Program Group *(continued)*

A572 [Speed Ratio]

 Stop drive before changing this parameter.

Scales the drive speed command.

Values	Default:	1.00
	Min/Max:	0.01/99.99
	Display:	0.01

A573 [Mtr Options Cfg]

 PowerFlex 525 only.

(With FRN 2.xx and later.)

Sets the configuration of the motor option.

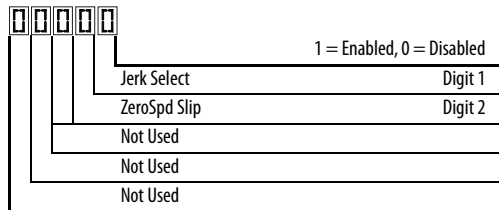

Options	Description
Jerk Select	Limits the rate of change to the velocity reference for improved current limiting. Set to 0 "Disabled" for positioning type applications with fast Accel or Decel times.
ZeroSpd Slip	Sets slip compensation to 0.0 Hz when the following conditions are met: <ul style="list-style-type: none"> Commanded speed = 0.00 Hz Status of drive = "At speed" ZeroSpd Slip = 1 "Enabled"

Values	Default:	11
	Min/Max:	00/11
	Display:	00

A574 [RdyBit Mode Cfg]

Related Parameter(s): [d392](#)

 Stop drive before changing this parameter.

 PowerFlex 525 only.

(With FRN 3.xxx and later.)

Determines which Stop conditions causes the drive's Ready bit (Network Logic Status bit 1) to go low (0). A reset or power cycle is required after selection is made.

Stop Conditions	Ready Bit Status ⁽¹⁾	
	Standard	Enhanced
Drive fault	0	0
Stop digital input terminal 01/11 open	1	0
Holding down the drive's keypad or the Remote DSI HIM Stop button	1	0
Stop commanded through Comms (Stop bit = 1)	1	0
Software (SW) Enable digital input terminal open	1	0
Safe-Torque-Off (STO) condition with value of t105 [Safety Open En] set to 1 "FaultDisabled"	0	0

(1) 1 = Active, 0 = Inactive

Options	0 "Standard" (Default)
	1 "Enhanced"

Network Parameter Group

This group contains parameters for the network option card that is installed.

Refer to the network option card's user manual for more information on the available parameters.

Modified Parameter Group

This group contains parameters that have their values changed from the factory default.

When a parameter has its default value changed, it is automatically added to this group. When a parameter has its value changed back to the factory default, it is automatically removed from this group.

Fault and Diagnostic Group

- F604 [Fault 4 Code]
- F605 [Fault 5 Code]
- F606 [Fault 6 Code]
- F607 [Fault 7 Code]
- F608 [Fault 8 Code]
- F609 [Fault 9 Code]
- F610 [Fault10 Code]

Related Parameter(s): [b007-b009](#)

A code that represents a drive fault. The codes appear in these parameters in the order they occur (b007 [Fault 1 Code] = the most recent fault). Repetitive faults are only recorded once.

Values	Default:	Read Only
	Min/Max:	F0/F127
	Display:	F0

- F611 [Fault 1 Time-hr] F612 [Fault 2 Time-hr]
- F613 [Fault 3 Time-hr] F614 [Fault 4 Time-hr]
- F615 [Fault 5 Time-hr]

Related Parameter(s): [d362](#)

F616 [Fault 6 Time-hr] F617 [Fault 7 Time-hr]
F618 [Fault 8 Time-hr] F619 [Fault 9 Time-hr]
F620 [Fault10 Time-hr]
<small>(PF 525) PowerFlex 525 only.</small>

Displays the value of [d362](#) [Elapsed Time-hr] when the fault occurs.

Values	Default:	Read Only
	Min/Max:	0/32767 hr
	Display:	1 hr

- F621 [Fault 1 Time-min] F622 [Fault 2 Time-min]
- F623 [Fault 3 Time-min] F624 [Fault 4 Time-min]
- F625 [Fault 5 Time-min]

Related Parameter(s): [d363](#)

F626 [Fault 6 Time-min] F627 [Fault 7 Time-min]
F628 [Fault 8 Time-min] F629 [Fault 9 Time-min]
F630 [Fault10 Time-min]
<small>(PF 525) PowerFlex 525 only.</small>

Displays the value of [d363](#) [Elapsed Time-min] when the fault occurs.

Values	Default:	Read Only
	Min/Max:	0.0/320.0 min
	Display:	0.1 min

Fault and Diagnostic Group *(continued)*

F631 [Fault 1 Freq] **F632 [Fault 2 Freq]**
F633 [Fault 3 Freq] **F634 [Fault 4 Freq]**
F635 [Fault 5 Freq]

Related Parameter(s): [b001](#)

F636 [Fault 6 Freq] **F637 [Fault 7 Freq]**
F638 [Fault 8 Freq] **F639 [Fault 9 Freq]**
F640 [Fault10 Freq]
(PF 525) PowerFlex 525 only.

Displays and stores the value of [b001](#) [Output Freq] with the most recent 10 faults occurred.
[Fault 1 Freq] stores the most recent fault, [Fault 2 Freq] stores the second most recent fault and [Fault 3 Freq] stores the third most recent fault.

Values	Default:	Read Only
	Min/Max:	0.00/500.00 Hz
	Display:	0.01 Hz

F641 [Fault 1 Current] **F642 [Fault 2 Current]**
F643 [Fault 3 Current] **F644 [Fault 4 Current]**
F645 [Fault 5 Current]

Related Parameter(s): [b003](#)

F646 [Fault 6 Current] **F647 [Fault 7 Current]**
F648 [Fault 8 Current] **F649 [Fault 9 Current]**
F650 [Fault10 Current]
(PF 525) PowerFlex 525 only.

Displays and stores the value of [b003](#) [Output Current] with the most recent 10 faults occurred.
[Fault 1 Current] stores the most recent fault, [Fault 2 Current] stores the second most recent fault and [Fault 3 Current] stores the third most recent fault.

Values	Default:	Read Only
	Min/Max:	0.00/(Drive Rated Amps x 2)
	Display:	0.01 A

F651 [Fault 1 BusVolts] **F652 [Fault 2 BusVolts]**
F653 [Fault 3 BusVolts] **F654 [Fault 4 BusVolts]**
F655 [Fault 5 BusVolts]

Related Parameter(s): [b005](#)

F656 [Fault 6 BusVolts] **F657 [Fault 7 BusVolts]**
F658 [Fault 8 BusVolts] **F659 [Fault 9 BusVolts]**
F660 [Fault10 BusVolts]
(PF 525) PowerFlex 525 only.

Displays and stores the value of [b005](#) [DC Bus Voltage] with the most recent 10 faults occurred.
[Fault 1 BusVolts] stores the most recent fault, [Fault2 BusVolts] stores the second most recent fault and [Fault 3 BusVolts] stores the third most recent fault.

Values	Default:	Read Only
	Min/Max:	0/1200VDC
	Display:	1VDC

Fault and Diagnostic Group (continued)

Related Parameter(s): [b006](#)

F661 [Status @ Fault 1] F662 [Status @ Fault 2]
 F663 [Status @ Fault 3] F664 [Status @ Fault 4]
 F665 [Status @ Fault 5]

F666 [Status @ Fault 6] F667 [Status @ Fault 7]
 F668 [Status @ Fault 8] F669 [Status @ Fault 9]
 F670 [Status @ Fault 10]

[PF 525] PowerFlex 525 only.

Displays the value of [b006](#) [Drive Status] with the most recent 10 faults occurred. [Status@ Fault 1] stores the most recent fault, [Status@ Fault 2] stores the second most recent fault and [Status@ Fault 3] stores the third most recent fault.

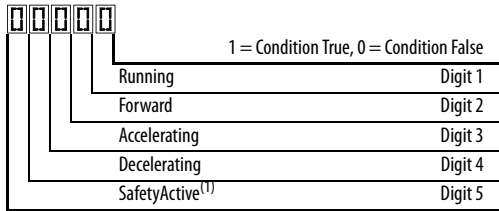

(1) Setting is specific to PowerFlex 525 drives only.

Values	Default:	Read Only
	Min/Max:	0/0x1F
	Display:	1

F681 [Comm Sts - DSI]

Displays the status of the RS485 serial (DSI) port to the drive.

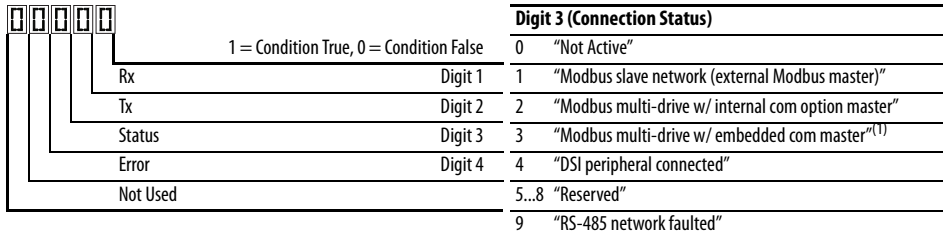

Digit 3 (Connection Status)	
0	"Not Active"
1	"Modbus slave network (external Modbus master)"
2	"Modbus multi-drive w/ internal com option master"
3	"Modbus multi-drive w/ embedded com master" ⁽¹⁾
4	"DSI peripheral connected"
5..8	"Reserved"
9	"RS-485 network faulted"

(1) Setting is specific to PowerFlex 525 drives only.

Values	Default:	Read Only
	Min/Max:	0000/1911
	Display:	0000

F682 [Comm Sts - Opt]

Displays the status of the internal communication to the drive.

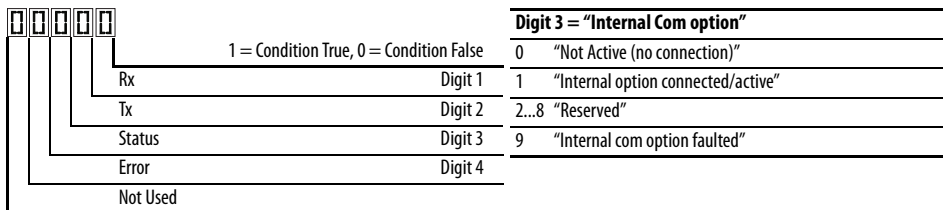

Digit 3 = "Internal Com option"	
0	"Not Active (no connection)"
1	"Internal option connected/active"
2..8	"Reserved"
9	"Internal com option faulted"

Values	Default:	Read Only
	Min/Max:	0000/1911
	Display:	0000

Fault and Diagnostic Group *(continued)*

F683 [Com Sts-Emb Enet]

PF 525 PowerFlex 525 only.

Displays the status of the embedded EtherNet/IP interface to the drive.

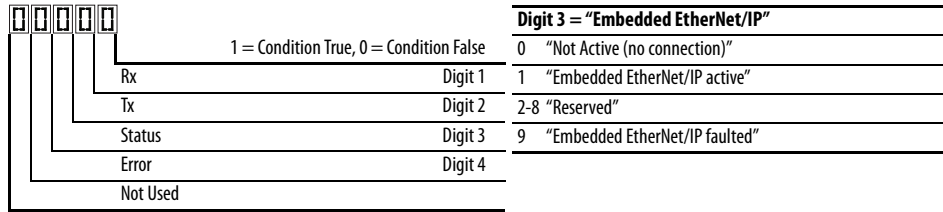

Values	Default:	Read Only
	Min/Max:	0000/1911
	Display:	0000

F684 [EN Addr Src]

PF 525 PowerFlex 525 only.

Displays the actual source of the Ethernet configuration (IP address, subnet mask, and gateway address).

Options	1	"Parameters"	Read Only
	2	"BOOTP"	

F685 [EN Rate Act]

PF 525 PowerFlex 525 only.

Displays the network data rate currently used by the embedded EtherNet/IP interface.

Options	0	"No Link"	Read Only
	1	"10Mbps Full"	
	2	"10Mbps Half"	
	3	"100Mbps Full"	
	4	"100Mbps Half"	
	5	"Dup IP Addr"	
	6	"Disabled"	

F686 [DSI I/O Act]

Displays the Drives that are active in Multi-Drive mode.

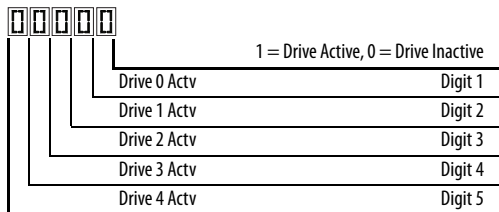

Value	Default:	Read Only
	Min/Max:	00000/11111
	Display:	00000

Fault and Diagnostic Group *(continued)*

- F687** [HW Addr 1]
- F688** [HW Addr 2]
- F689** [HW Addr 3]
- F690** [HW Addr 4]
- F691** [HW Addr 5]
- F692** [HW Addr 6]

[PF 525] PowerFlex 525 only.

Shows the MAC address for the embedded EtherNet/IP interface.

Values	Default:	Read Only
	Min/Max:	0/255
	Display:	1

- F693** [EN IP Addr Act 1]
- F694** [EN IP Addr Act 2]
- F695** [EN IP Addr Act 3]
- F696** [EN IP Addr Act 4]

[PF 525] PowerFlex 525 only.

Shows the actual IP address used by the embedded EtherNet/IP interface at the time. This indicates 0 if no address is set.

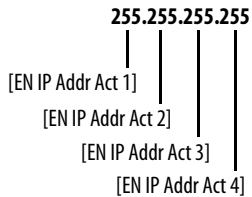

Values	Default:	Read Only
	Min/Max:	0/255
	Display:	1

- F697** [EN Subnet Act 1]
- F698** [EN Subnet Act 2]
- F699** [EN Subnet Act 3]
- F700** [EN Subnet Act 4]

[PF 525] PowerFlex 525 only.

Shows the actual subnet mask used by the embedded EtherNet/IP interface at the time. This will indicate 0 if no address is set.

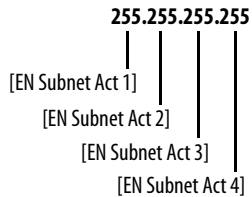

Values	Default:	Read Only
	Min/Max:	0/255
	Display:	1

Fault and Diagnostic Group *(continued)*

- F701 [EN Gateway Act 1]**
- F702 [EN Gateway Act 2]**
- F703 [EN Gateway Act 3]**
- F704 [EN Gateway Act 4]**

(PF 525) PowerFlex 525 only.

Shows the actual gateway address used by the embedded EtherNet/IP interface at the time. This will indicate 0 if no address is set.

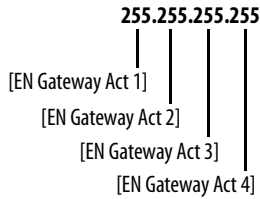

Values	Default:	Read Only
	Min/Max:	0/255
	Display:	1

- F705 [Drv 0 Logic Cmd]**
- F709 [Drv 1 Logic Cmd]**
- F713 [Drv 2 Logic Cmd]**
- F717 [Drv 3 Logic Cmd]**
- F721 [Drv 4 Logic Cmd]**

In multi-drive mode, this is the logic command being transmitted to drive 0/1/2/3/4.

In single-drive mode, this is the logic command being used by the drive (whether HS-DSI, EtherNet/IP, or DSI) at the time. If comms control is NOT being used, and the drive is in single-drive mode, then this parameter will show 0.

Values	Default:	Read Only
	Min/Max:	0/FFFF
	Display:	1

- F706 [Drv 0 Reference]**
- F710 [Drv 1 Reference]**
- F714 [Drv 2 Reference]**
- F718 [Drv 3 Reference]**
- F722 [Drv 4 Reference]**

In multi-drive mode, this is the reference being transmitted to drive 0/1/2/3/4.

In single-drive mode, this is the reference being used by the drive (whether HS-DSI, EtherNet/IP, or DSI) at the time. If comms control is NOT being used, and the drive is in single-drive mode, then this parameter will show 0.

Values	Default:	Read Only
	Min/Max:	0.00/500.00 Hz
	Display:	0.01 Hz

- F707 [Drv 0 Logic Sts]**
- F711 [Drv 1 Logic Sts]**
- F715 [Drv 2 Logic Sts]**
- F719 [Drv 3 Logic Sts]**
- F723 [Drv 4 Logic Sts]**

In multi-drive mode, this is the logic status being received from drive 0/1/2/3/4.

In single-drive mode, this is the logic status of the drive at the time.

Values	Default:	Read Only
	Min/Max:	0/FFFF
	Display:	1

Fault and Diagnostic Group *(continued)*

- F708 [Drv 0 Feedback]**
- F712 [Drv 1 Feedback]**
- F716 [Drv 2 Feedback]**
- F720 [Drv 3 Feedback]**
- F724 [Drv 4 Feedback]**

In multi-drive mode, this is the feedback being received from drive 0/1/2/3/4.
 In single-drive mode, this is the feedback of the drive at the time.

Values	Default:	Read Only
	Min/Max:	0.00/500.00 Hz
	Display:	0.01 Hz

F725 [EN Rx Overruns]

(PF 525) PowerFlex 525 only.

A count of the number of receive overrun errors reported by the embedded EtherNet/IP interface.

Values	Default:	Read Only
	Min/Max:	0/65535
	Display:	1

F726 [EN Rx Packets]

(PF 525) PowerFlex 525 only.

A count of the number of receive packets reported by the embedded EtherNet/IP interface.

Values	Default:	Read Only
	Min/Max:	0/65535
	Display:	1

F727 [EN Rx Errors]

(PF 525) PowerFlex 525 only.

A count of the number of receive errors reported by the embedded EtherNet/IP interface.

Values	Default:	Read Only
	Min/Max:	0/65535
	Display:	1

F728 [EN Tx Packets]

(PF 525) PowerFlex 525 only.

A count of the number of transmitted packets reported by the embedded EtherNet/IP interface.

Values	Default:	Read Only
	Min/Max:	0/65535
	Display:	1

F729 [EN Tx Errors]

(PF 525) PowerFlex 525 only.

A count of the number of transmit errors reported by the embedded EtherNet/IP interface.

Values	Default:	Read Only
	Min/Max:	0/65535
	Display:	1

Fault and Diagnostic Group *(continued)***F730 [EN Missed IO Pkt]**PF 525 PowerFlex 525 only.

The number of I/O packets missed.

Values	Default:	Read Only
	Min/Max:	0/65535
	Display:	1

F731 [DSI Errors]

The number of total DSI errors.

Values	Default:	Read Only
	Min/Max:	0/65535
	Display:	1

AppView Parameter Groups





AppView parameter groups provide a simple starting point for using the PowerFlex 520-series drives by grouping certain commonly used parameters based on different types of applications. Use these parameter groups to quickly and easily setup the PowerFlex 520-series drive for your application.

AppView parameter groups are available for the following applications:

- Conveyor
- Mixer
- Compressor
- Centrifugal Pump
- Blower/Fan
- Extruder
- Positioning (PowerFlex 525 only)
- Textile/Fiber

You cannot add or remove parameters to or from the AppView parameter groups. If you require quick access to additional parameters to what is already included in the different AppView parameter groups, use the CustomView parameter group instead.

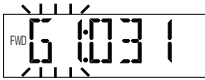
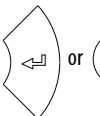
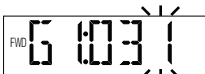

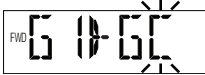
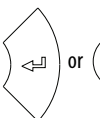
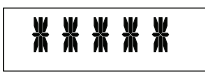





The parameters in the AppView parameter groups can be quickly added to the CustomView parameter group by doing the following:

Step	Key(s)	Example Displays
1. Press the Up Arrow or Down Arrow to scroll to an AppView group (G1...G8).	 or 	
2. Press Enter or Sel to enter a group. The right most digit of the last viewed parameter in that group will flash.	 or Sel	
3. Press the Up Arrow or Down Arrow to scroll to the command G1->GC.	 or 	
4. Press Enter or Sel to add all the parameters in this AppView group to the CustomView group. The LCD display will show a confirmation.	 or Sel	

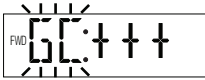





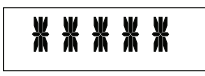





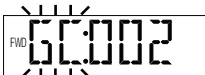

CustomView Parameter Group

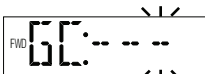
CustomView allows you to quickly access only the parameters needed for your application by storing them in a custom parameter group. Add your frequently used parameters to this group, then hide all other parameters with [A552](#) [Program Lock] to simplify your drive configuration process.

Up to 100 parameters can be stored in the CustomView parameter group. You can copy one entire AppView parameter group to the CustomView parameter group as shown on [page 138](#) or add individual parameters as show below.

Step	Key(s)	Example Displays
1. Press the Up Arrow or Down Arrow to scroll to the CustomView group (GC).	 or 	
2. Press Enter to view the parameters that can be added to the CustomView group.		
3. Press the Up Arrow or Down Arrow to scroll through the list of parameters.	 or 	
4. Press Enter to add the parameter to the CustomView group. The LCD display will show a confirmation.		

To delete parameters from the CustomView parameter group:

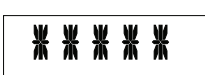
Step	Key(s)	Example Displays
1. Press the Up Arrow or Down Arrow to scroll to the CustomView group (GC).	 or 	
2. Press Enter to view the parameters that are in the CustomView group.		
3. Press the Up Arrow or Down Arrow to scroll to the command GC---	 or 	
4. Press Enter or Sel to view the parameters that are stored in the CustomView group.	 or 	
5. Press the Up Arrow or Down Arrow to scroll through the list of parameters.	 or 	
6. Press Enter to delete the parameter from the CustomView group. The LCD display will show a confirmation.		

TIP The Connected Components Workbench software can be used to speed up this process with drag and drop functionality.

Parameter Cross Reference by Name

Parameter Name	No.
10V Bipolar Enbl ⁽¹⁾	093
2-Wire Mode	064
Accel Time 1	041
Accel Time 2	442
Accel Time 3	444
Accel Time 4	446
Accum CO2 Sav	026
Accum Cost Sav	025
Accum kWh Sav	024
Analog In 0-10V	360
Analog In 4-20mA	361
Analog In Filter	099
Analog Out High ⁽¹⁾	089
Analog Out Sel ⁽¹⁾	088
Anlg In 0-10V Hi	092
Anlg In 0-10V Lo	091
Anlg In mA Loss	097
Anlg In V Loss	094
Anlg In4-20mA Hi	096
Anlg In4-20mA Lo	095
Anlg Loss Delay	098
Anlg Out Setpt ⁽¹⁾	090
Auto Rstrt Delay	542
Auto Rstrt Tries	541
Autotune	040
Average kWh Cost	052
Average Power	020
Boost Select	530
Break Frequency	533
Break Voltage	532
Bus Reg Enable	550
Cmd Stat Select ⁽¹⁾	122
Com Sts-Emb Enet ⁽¹⁾	683
Comm Loss Action	125
Comm Loss Time	126
Comm Sts - DSI	681
Comm Sts - Opt	682
Comm Write Mode	121
Commanded Freq	002
Compensation	547
Contrl In Status	013
Control Source	012
Control SW Ver	029
Control Temp	028
Counter Status	364
Counts Per Unit ⁽¹⁾	559
Current Limit 1	484

Parameter Name	No.
Current Limit 2 ⁽¹⁾	485
DB Resistor Sel	437
DB Threshold	438
DC Brake Level	435
DC Brake Time	434
DC Brk Time@Strt	436
DC Bus Ripple	380
DC Bus Voltage	005
Decel Time 1	042
Decel Time 2	443
Decel Time 3	445
Decel Time 4	447
Dig In Status	014
DigIn TermBlk 02	062
DigIn TermBlk 03	063
DigIn TermBlk 05	065
DigIn TermBlk 06	066
DigIn TermBlk 07 ⁽¹⁾	067
DigIn TermBlk 08 ⁽¹⁾	068
Drive OL Mode	495
Drive Status	006
Drive Temp	027
Drive Type	367
Droop Hertz@ FLA ⁽¹⁾	441
Drv 0 Feedback	708
Drv 0 Logic Cmd	705
Drv 0 Logic Sts	707
Drv 0 Reference	706
Drv 1 Addr	171
Drv 1 Feedback	712
Drv 1 Logic Cmd	709
Drv 1 Logic Sts	711
Drv 1 Reference	710
Drv 2 Addr	172
Drv 2 Feedback	716
Drv 2 Logic Cmd	713
Drv 2 Logic Sts	715
Drv 2 Reference	714
Drv 3 Addr	173
Drv 3 Feedback	720
Drv 3 Logic Cmd	717
Drv 3 Logic Sts	719
Drv 3 Reference	718
Drv 4 Addr	174
Drv 4 Feedback	724
Drv 4 Logic Cmd	721
Drv 4 Logic Sts	723

Parameter Name	No.
Drv 4 Reference	722
Drv Ambient Sel	554
DSI Errors	731
DSI I/O Act	686
DSI I/O Cfg	175
Elapsed kWh	021
Elapsed MWh	022
Elapsed Run Time	019
Elapsed Time-hr	362
Elapsed Time-min	363
EM Brk Off Delay	086
EM Brk On Delay	087
EN Addr Sel ⁽¹⁾	128
EN Addr Src ⁽¹⁾	684
EN Comm Flt Actn ⁽¹⁾	143
EN Data In 1 ⁽¹⁾	153
EN Data In 2 ⁽¹⁾	154
EN Data In 3 ⁽¹⁾	155
EN Data In 4 ⁽¹⁾	156
EN Data Out 1 ⁽¹⁾	157
EN Data Out 2 ⁽¹⁾	158
EN Data Out 3 ⁽¹⁾	159
EN Data Out 4 ⁽¹⁾	160
EN Flt Cfg DL 1 ⁽¹⁾	147
EN Flt Cfg DL 2 ⁽¹⁾	148
EN Flt Cfg DL 3 ⁽¹⁾	149
EN Flt Cfg DL 4 ⁽¹⁾	150
EN Flt Cfg Logic ⁽¹⁾	145
EN Flt Cfg Ref ⁽¹⁾	146
EN Gateway Act 1 ⁽¹⁾	701
EN Gateway Act 2 ⁽¹⁾	702
EN Gateway Act 3 ⁽¹⁾	703
EN Gateway Act 4 ⁽¹⁾	704
EN Gateway Cfg 1 ⁽¹⁾	137
EN Gateway Cfg 2 ⁽¹⁾	138
EN Gateway Cfg 3 ⁽¹⁾	139
EN Gateway Cfg 4 ⁽¹⁾	140
EN Idle Flt Actn ⁽¹⁾	144
EN IP Addr Act 1 ⁽¹⁾	693
EN IP Addr Act 2 ⁽¹⁾	694
EN IP Addr Act 3 ⁽¹⁾	695
EN IP Addr Act 4 ⁽¹⁾	696
EN IP Addr Cfg 1 ⁽¹⁾	129
EN IP Addr Cfg 2 ⁽¹⁾	130
EN IP Addr Cfg 3 ⁽¹⁾	131
EN IP Addr Cfg 4 ⁽¹⁾	132
EN Missed IO Pkt ⁽¹⁾	730

(1) Parameter is specific to PowerFlex 525 drives only.

Parameter Name	No.
EN Rate Act ⁽¹⁾	685
EN Rate Cfg ⁽¹⁾	141
EN Rx Errors ⁽¹⁾	727
EN Rx Overruns ⁽¹⁾	725
EN Rx Packets ⁽¹⁾	726
EN Subnet Act 1 ⁽¹⁾	697
EN Subnet Act 2 ⁽¹⁾	698
EN Subnet Act 3 ⁽¹⁾	699
EN Subnet Act 4 ⁽¹⁾	700
EN Subnet Cfg 1 ⁽¹⁾	133
EN Subnet Cfg 2 ⁽¹⁾	134
EN Subnet Cfg 3 ⁽¹⁾	135
EN Subnet Cfg 4 ⁽¹⁾	136
EN Tx Errors ⁽¹⁾	729
EN Tx Packets ⁽¹⁾	728
Encoder Pos Tol ⁽¹⁾	564
Encoder PPR ⁽¹⁾	536
Encoder Speed ⁽¹⁾	378
Energy Saved	023
Enh Control Word ⁽¹⁾	560
Fault 1 BusVolts	651
Fault 1 Code	007
Fault 1 Current	641
Fault 1 Freq	631
Fault 1 Time-hr	611
Fault 1 Time-min	621
Fault 2 BusVolts	652
Fault 2 Code	008
Fault 2 Current	642
Fault 2 Freq	632
Fault 2 Time-hr	612
Fault 2 Time-min	622
Fault 3 BusVolts	653
Fault 3 Code	009
Fault 3 Current	643
Fault 3 Freq	633
Fault 3 Time-hr	613
Fault 3 Time-min	623
Fault 4 BusVolts	654
Fault 4 Code	604
Fault 4 Current	644
Fault 4 Freq	634
Fault 4 Time-hr	614
Fault 4 Time-min	624
Fault 5 BusVolts	655
Fault 5 Code	605
Fault 5 Current	645
Fault 5 Freq	635

Parameter Name	No.
Fault 5 Time-hr	615
Fault 5 Time-min	625
Fault 6 BusVolts ⁽¹⁾	656
Fault 6 Code ⁽¹⁾	606
Fault 6 Current ⁽¹⁾	646
Fault 6 Freq ⁽¹⁾	636
Fault 6 Time-hr ⁽¹⁾	616
Fault 6 Time-min ⁽¹⁾	626
Fault 7 BusVolts ⁽¹⁾	657
Fault 7 Code ⁽¹⁾	607
Fault 7 Current ⁽¹⁾	647
Fault 7 Freq ⁽¹⁾	637
Fault 7 Time-hr ⁽¹⁾	617
Fault 7 Time-min ⁽¹⁾	627
Fault 8 BusVolts ⁽¹⁾	658
Fault 8 Code ⁽¹⁾	608
Fault 8 Current ⁽¹⁾	648
Fault 8 Freq ⁽¹⁾	638
Fault 8 Time-hr ⁽¹⁾	618
Fault 8 Time-min ⁽¹⁾	628
Fault 9 BusVolts ⁽¹⁾	659
Fault 9 Code ⁽¹⁾	609
Fault 9 Current ⁽¹⁾	649
Fault 9 Freq ⁽¹⁾	639
Fault 9 Time-hr ⁽¹⁾	619
Fault 9 Time-min ⁽¹⁾	629
Fault Clear	551
Fault10 BusVolts ⁽¹⁾	660
Fault10 Code ⁽¹⁾	610
Fault10 Current ⁽¹⁾	650
Fault10 Freq ⁽¹⁾	640
Fault10 Time-hr ⁽¹⁾	620
Fault10 Time-min ⁽¹⁾	630
Fiber Status	390
Find Home Dir ⁽¹⁾	563
Find Home Freq ⁽¹⁾	562
Flux Current Ref	497
Flying Start En	545
FlyStrt CurLimit	546
Freq 1 ⁽¹⁾	510
Freq 1 BW ⁽¹⁾	511
Freq 1 Ki ⁽¹⁾	522
Freq 1 Kp ⁽¹⁾	521
Freq 2 ⁽¹⁾	512
Freq 2 BW ⁽¹⁾	513
Freq 2 Ki ⁽¹⁾	524
Freq 2 Kp ⁽¹⁾	523
Freq 3 ⁽¹⁾	514

Parameter Name	No.
Freq 3 BW ⁽¹⁾	515
Freq 3 Ki ⁽¹⁾	526
Freq 3 Kp ⁽¹⁾	525
Half Bus Enable	549
Home Save ⁽¹⁾	561
HW Addr 1 ⁽¹⁾	687
HW Addr 2 ⁽¹⁾	688
HW Addr 3v	689
HW Addr 4 ⁽¹⁾	690
HW Addr 5 ⁽¹⁾	691
HW Addr 6 ⁽¹⁾	692
IR Voltage Drop	496
Jog Accel/Decel	432
Jog Frequency	431
Keypad Freq	426
Ki Speed Loop ⁽¹⁾	538
Kp Speed Loop ⁽¹⁾	539
Language	30
Load Loss Level ⁽¹⁾	490
Load Loss Time ⁽¹⁾	491
Max Traverse	567
Maximum Freq	044
Maximum Voltage	534
Minimum Freq	043
MOP Freq	427
MOP Preload	429
MOP Reset Sel	428
MOP Time	430
Motor Fdbk Type ⁽¹⁾	535
Motor Lm ⁽¹⁾	499
Motor Lx ⁽¹⁾	500
Motor NP FLA	034
Motor NP Hertz	032
Motor NP Poles	035
Motor NP Power ⁽¹⁾	037
Motor NP RPM	036
Motor NP Volts	031
Motor OL Current	033
Motor OL Level	369
Motor OL Ret	494
Motor OL Select	493
Motor Rr ⁽¹⁾	498
Mtr Options Cfg	573
MultiDrv Sel	169
Opt Data In 1	161
Opt Data In 2	162
Opt Data In 3	163
Opt Data In 4	164

(1) Parameter is specific to PowerFlex 525 drives only.

Parameter Name	No.
Opt Data Out 1	165
Opt Data Out 2	166
Opt Data Out 3	167
Opt Data Out 4	168
Opto Out Logic ⁽¹⁾	075
Opto Out1 Level ⁽¹⁾	070
Opto Out1 Sel ⁽¹⁾	069
Opto Out2 Level ⁽¹⁾	073
Opto Out2 Sel ⁽¹⁾	072
Out Phas Loss En	557
Output Current	003
Output Freq	001
Output Power	017
Output Powr Fctr	381
Output RPM	015
Output Speed	016
Output Voltage	004
P Jump	570
PID 1 Deadband	465
PID 1 Diff Rate	463
PID 1 Fdbck Sel	460
PID 1 Integ Time	462
PID 1 Invert Err	467
PID 1 Preload	466
PID 1 Prop Gain	461
PID 1 Ref Sel	459
PID 1 Setpoint	464
PID 1 Trim Hi	456
PID 1 Trim Lo	457
PID 1 Trim Sel	458
PID1 Fdbk Displ	383
PID1 Setpnt Disp	384
PID 2 Deadband ⁽¹⁾	477
PID 2 Diff Rate ⁽¹⁾	475
PID 2 Fdbck Sel ⁽¹⁾	472
PID 2 Integ Time ⁽¹⁾	474
PID 2 Invert Err ⁽¹⁾	479
PID 2 Preload ⁽¹⁾	478
PID 2 Prop Gain ⁽¹⁾	473
PID 2 Ref Sel ⁽¹⁾	471
PID 2 Setpoint ⁽¹⁾	476
PID 2 Trim Hi ⁽¹⁾	468
PID 2 Trim Lo ⁽¹⁾	469
PID 2 Trim Sel ⁽¹⁾	470
PID2 Fdbk Displ ⁽¹⁾	385
PID2 Setpnt Disp ⁽¹⁾	386
Pos Reg Filter ⁽¹⁾	565
Pos Reg Gain ⁽¹⁾	566

Parameter Name	No.
Position Status ⁽¹⁾	387
Positioning Mode ⁽¹⁾	558
Power Loss Mode	548
Power Saved	018
Preset Freq 0	410
Preset Freq 1	411
Preset Freq 2	412
Preset Freq 3	413
Preset Freq 4	414
Preset Freq 5	415
Preset Freq 6	416
Preset Freq 7	417
Preset Freq 8 ⁽¹⁾	418
Preset Freq 9 ⁽¹⁾	419
Preset Freq 10 ⁽¹⁾	420
Preset Freq 11 ⁽¹⁾	421
Preset Freq 12 ⁽¹⁾	422
Preset Freq 13 ⁽¹⁾	423
Preset Freq 14 ⁽¹⁾	424
Preset Freq 15 ⁽¹⁾	425
Process Disp Hi	482
Process Disp Lo	481
Process Display	010
Program Lock	552
Program Lock Mod	553
Pulse In Scale	537
Purge Frequency	433
PWM Frequency	440
RdyBit Mode Act	392
RdyBit Mode Cfg	574
Relay 1 Off Time	080
Relay 1 On Time	079
Relay Out1 Level	077
Relay Out1 Sel	076
Relay 2 Off Time ⁽¹⁾	085
Relay 2 On Time ⁽¹⁾	084
Relay Out2 Level ⁽¹⁾	082
Relay Out2 Sel ⁽¹⁾	081
Reset Meters	555
Reset to Defaults	053
Reverse Disable	544
RS485 Data Rate	123
RS485 Format	127
RS485 Node Addr	124
S Curve %	439
Safety Open En ⁽¹⁾	105
Shear Pin 1 Time	487
Shear Pin1 Level	486

Parameter Name	No.
Shear Pin 2 Time ⁽¹⁾	489
Shear Pin2 Level ⁽¹⁾	488
Skip Freq Band 1	449
Skip Freq Band 2	451
Skip Freq Band 3 ⁽¹⁾	453
Skip Freq Band 4 ⁽¹⁾	455
Skip Frequency 1	448
Skip Frequency 2	450
Skip Frequency 3 ⁽¹⁾	452
Skip Frequency 4 ⁽¹⁾	454
Sleep Level	101
Sleep Time	102
Sleep-Wake Sel	100
Slip Hz Meter	375
Speed Feedback	376
Speed Ratio	572
Speed Reference1	047
Speed Reference2	049
Speed Reference3	051
Speed Reg Sel ⁽¹⁾	509
Stall Fault Time	492
Start At PowerUp	543
Start Boost	531
Start Source 1	046
Start Source 2	048
Start Source 3	050
Status @ Fault 1	661
Status @ Fault 2	662
Status @ Fault 3	663
Status @ Fault 4	664
Status @ Fault 5	665
Status @ Fault 6 ⁽¹⁾	666
Status @ Fault 7 ⁽¹⁾	667
Status @ Fault 8 ⁽¹⁾	668
Status @ Fault 9 ⁽¹⁾	669
Status @ Fault10 ⁽¹⁾	670
Step Units 0 ⁽¹⁾	200
Step Units 1 ⁽¹⁾	202
Step Units 2 ⁽¹⁾	204
Step Units 3 ⁽¹⁾	206
Step Units 4 ⁽¹⁾	208
Step Units 5 ⁽¹⁾	210
Step Units 6 ⁽¹⁾	212
Step Units 7 ⁽¹⁾	214
Stop Mode	045
Stp Logic 0 ⁽¹⁾	180
Stp Logic 1 ⁽¹⁾	181
Stp Logic 2 ⁽¹⁾	182

(1) Parameter is specific to PowerFlex 525 drives only.

Parameter Name	No.
Stp Logic 3 ⁽¹⁾	183
Stp Logic 4 ⁽¹⁾	184
Stp Logic 5 ⁽¹⁾	185
Stp Logic 6 ⁽¹⁾	186
Stp Logic 7 ⁽¹⁾	187
Stp Logic Status ⁽¹⁾	391
Stp Logic Time 0 ⁽¹⁾	190
Stp Logic Time 1 ⁽¹⁾	191
Stp Logic Time 2 ⁽¹⁾	192
Stp Logic Time 3 ⁽¹⁾	193

Parameter Name	No.
Stp Logic Time 4 ⁽¹⁾	194
Stp Logic Time 5 ⁽¹⁾	195
Stp Logic Time 6 ⁽¹⁾	196
Stp Logic Time 7 ⁽¹⁾	197
Sync Time	571
Testpoint Data	368
Testpoint Sel	483
Text Scroll	556
Timer Status	365
Torque Current	382

Parameter Name	No.
Torque Perf Mode	039
Traverse Dec	569
Traverse Inc	568
Units Traveled H ⁽¹⁾	388
Units Traveled L ⁽¹⁾	389
Var PWM Disable	540
Voltage Class	038
Wake Level	103
Wake Time	104

(1) Parameter is specific to PowerFlex 525 drives only.

Notes:

Troubleshooting

This chapter provides information to guide you in troubleshooting the PowerFlex 520-series drive. Included is a listing and description of drive faults with possible solutions, when applicable.

For information on...	See page...
Drive Status	145
Faults	145
Fault Descriptions	147
Common Symptoms and Corrective Actions	150



ATTENTION: Risk of injury or equipment damage exists. Drive does not contain user-serviceable components. Do not disassemble drive chassis.

Drive Status

The condition or state of your drive is constantly monitored. Any changes will be indicated through the integral LCD display.

See [Display and Control Keys on page 58](#) for information on drive status indicators and controls.

Faults

A fault is a condition that stops the drive. There are two fault types.

Fault Types

Type	Fault Description	
1	Auto-Reset/Run	When this type of fault occurs, and A541 [Auto Rstrt Tries] is set to a value greater than "0," a user-configurable timer, A542 [Auto Rstrt Delay], begins. When the timer reaches zero, the drive attempts to automatically reset the fault. If the condition that caused the fault is no longer present, the fault will be reset and the drive will be restarted.
2	Non-Resettable	This type of fault may require drive or motor repair, or is caused by wiring or programming errors. The cause of the fault must be corrected before the fault can be cleared.

Fault Indication

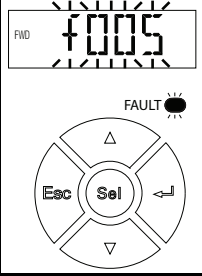
Condition	Display
<p>Drive is indicating a fault. The integral LCD display provides visual notification of a fault condition by displaying the following.</p> <ul style="list-style-type: none"> Flashing fault number Flashing fault indicator (LED) <p>Press the Esc key to regain control of the display.</p>	

Manually Clearing Faults

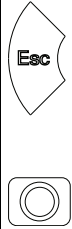
Step	Key(s)
<ol style="list-style-type: none"> Press Esc to acknowledge the fault. The fault information will be removed so that you can use the integral keypad. Access b007 [Fault 1 Code] to view the most recent fault information. Address the condition that caused the fault. The cause must be corrected before the fault can be cleared. See Fault Types, Descriptions and Actions on page 147. After corrective action has been taken, clear the fault by one of these methods. <ul style="list-style-type: none"> Press Stop if P045 [Stop Mode] is set to a value between "0" and "3". Cycle drive power. Set A551 [Fault Clear] to 1 "Reset Fault" or 2 "Clear Buffer". Cycle digital input if t062, t063, t065..t068 [DigIn TermBlk xx] is set to 13 "Clear Fault". 	

Automatically Clearing Faults

Option/Step	
<p>Clear a Type 1 fault and restart the drive.</p> <ol style="list-style-type: none"> Set A541 [Auto Rstrt Tries] to a value other than "0". Set A542 [Auto Rstrt Delay] to a value other than "0". 	
<p>Clear an OverVoltage, UnderVoltage or Heatsink OvrTmp fault without restarting the drive.</p> <ol style="list-style-type: none"> Set A541 [Auto Rstrt Tries] to a value other than "0". Set A542 [Auto Rstrt Delay] to "0". 	



ATTENTION: Equipment damage and/or personal injury may result if these parameters are used in an inappropriate application. Do not use this function without considering applicable local, national and international codes, standards, regulations or industry guidelines.

Auto Restart (Reset/Run)

The Auto Restart feature provides the ability for the drive to automatically perform a fault reset followed by a start attempt without user or application intervention. This allows remote or “unattended” operation. Only certain faults are allowed to be reset. Certain faults (Type 2) that indicate possible drive component malfunction are not resettable. Fault types are listed in the table [Fault Types on page 145](#). See [Fault Descriptions on page 147](#) for more information.

Use caution when enabling this feature, since the drive will attempt to issue its own start command based on user selected programming.

Fault Descriptions

Fault Types, Descriptions and Actions

No.	Fault	Type ⁽²⁾	Description	Action
F000	No Fault	–	No fault present.	–
F002	Auxiliary Input	1	External trip (Auxiliary) input.	<ul style="list-style-type: none"> • Check remote wiring. • Verify communications programming for intentional fault.
F003	Power Loss	2	Single phase operation detected with excessive load.	<ul style="list-style-type: none"> • Monitor the incoming AC line for low voltage or line power interruption. • Check input fuses. • Reduce load.
F004	UnderVoltage	1	DC bus voltage fell below the minimum value.	Monitor the incoming AC line for low voltage or line power interruption.
F005	OverVoltage	1	DC bus voltage exceeded maximum value.	Monitor the AC line for high line voltage or transient conditions. Bus overvoltage can also be caused by motor regeneration. Extend the decel time or install dynamic brake option.
F006	Motor Stalled	1	Drive is unable to accelerate or decelerate motor.	<ul style="list-style-type: none"> • Increase P041, A442, A444, A446 [Accel Time x] or reduce load so drive output current does not exceed the current set by parameter A484, A485 [Current Limit x] for too long. • Check for overhauling load.
F007	Motor Overload	1	Internal electronic overload trip.	<ul style="list-style-type: none"> • An excessive motor load exists. Reduce load so drive output current does not exceed the current set by parameter P033 [Motor OL Current]. • Verify A530 [Boost Select] setting.
F008	Heatsink OvrTmp	1	Heatsink/Power Module temperature exceeds a predefined value.	<ul style="list-style-type: none"> • Check for blocked or dirty heat sink fins. Verify that ambient temperature has not exceeded the rated ambient temperature. • Check fan.
F009	CC OvrTmp	1	Control module temperature exceeds a predefined value.	<ul style="list-style-type: none"> • Check product ambient temperature. • Check for airflow obstruction. • Check for dirt or debris. • Check fan.
F012	HW OverCurrent	2	The drive output current has exceeded the hardware current limit.	Check programming. Check for excess load, improper A530 [Boost Select] setting, DC brake volts set too high or other causes of excess current.
F013	Ground Fault	1 ⁽³⁾	A current path to earth ground has been detected at one or more of the drive output terminals.	Check the motor and external wiring to the drive output terminals for a grounded condition.

Fault Types, Descriptions and Actions

No.	Fault	Type ⁽²⁾	Description	Action
F015 ⁽¹⁾	Load Loss	2	The output torque current is below the value programmed in A490 [Load Loss Level] for a time period greater than the time programmed in A491 [Load Loss Time].	<ul style="list-style-type: none"> Verify connections between motor and load. Verify level and time requirements
F021	Output Ph Loss	1	Output Phase Loss (if enabled). Configure with A557 [Out Phas Loss En].	<ul style="list-style-type: none"> Verify motor wiring. Verify motor.
F029	Analog In Loss	1	An analog input is configured to fault on signal loss. A signal loss has occurred. Configure with t094 [Anlg In V Loss] or t097 [Anlg In mA Loss].	<ul style="list-style-type: none"> Check for broken/loose connections at inputs. Check parameters.
F033	Auto Rstrt Tries	2	Drive unsuccessfully attempted to reset a fault and resume running for the programmed number of A541 [Auto Rstrt Tries].	Correct the cause of the fault and manually clear.
F038	Phase U to Gnd	2	A phase to ground fault has been detected between the drive and motor in this phase.	<ul style="list-style-type: none"> Check the wiring between the drive and motor. Check motor for grounded phase. Replace drive if fault cannot be cleared.
F039	Phase V to Gnd			
F040	Phase W to Gnd			
F041	Phase UV Short	2	Excessive current has been detected between these two output terminals.	<ul style="list-style-type: none"> Check the motor and drive output terminal wiring for a shorted condition. Replace drive if fault cannot be cleared.
F042	Phase UW Short			
F043	Phase VW Short			
F048	Params Defaulted	1	The drive was commanded to write default values to EEPROM.	<ul style="list-style-type: none"> Clear the fault or cycle power to the drive. Program the drive parameters as needed.
F059 ⁽¹⁾	Safety Open	1	Both of the safety inputs (Safety 1, Safety 2) are not enabled. Configure with t105 [Safety Open En].	<ul style="list-style-type: none"> Check safety input signals. If not using safety, verify and tighten jumper for I/O terminals S1, S2 and S+.
F063	SW OverCurrent	1	Programmed A486 , A488 [Shear Pinx Level] has been exceeded for a time period greater than the time programmed in A487 , A489 [Shear Pin x Time].	<ul style="list-style-type: none"> Verify connections between motor and load. Verify level and time requirements.
F064	Drive Overload	2	Drive overload rating has been exceeded.	Reduce load or extend Accel Time.
F070	Power Unit	2	Failure has been detected in the drive power section.	<ul style="list-style-type: none"> Check maximum ambient temperature has not been exceeded. Cycle power. Replace drive if fault cannot be cleared.
F071	DSI Net Loss	2	Control over the Modbus or DSI communication link has been interrupted.	<ul style="list-style-type: none"> Cycle power. Check communications cabling. Check Modbus or DSI setting. Check Modbus or DSI status.
F072	Opt Net Loss	2	Control over the network option card's remote network has been interrupted.	<ul style="list-style-type: none"> Cycle power. Check communications cabling. Check network adapter setting. Check external network status.
F073 ⁽¹⁾	EN Net Loss	2	Control through the embedded EtherNet/IP adapter has been interrupted.	<ul style="list-style-type: none"> Cycle power. Check communications cabling. Check EtherNet/IP setting. Check external network status.
F080	Autotune Failure	2	The autotune function was either cancelled by the user or failed.	Restart procedure.

Fault Types, Descriptions and Actions

No.	Fault	Type ⁽²⁾	Description	Action
F081	DSI Comm Loss	2	Communications between the drive and the Modbus or DSI master device have been interrupted.	<ul style="list-style-type: none"> • Cycle power. • Check communications cabling. • Check Modbus or DSI setting. • Check Modbus or DSI status. • Modify using C125 [Comm Loss Action]. • Connecting I/O terminals C1 and C2 to ground may improve noise immunity. • Replace wiring, Modbus master device, or control module.
F082	Opt Comm Loss	2	Communications between the drive and the network option card have been interrupted.	<ul style="list-style-type: none"> • Cycle power. • Reinstall option card in drive. • Modify using C125 [Comm Loss Action]. • Replace wiring, port expander, option card, or control module.
F083 ⁽¹⁾	EN Comm Loss	2	Internal communications between the drive and the embedded EtherNet/IP adapter have been interrupted.	<ul style="list-style-type: none"> • Cycle power. • Check EtherNet/IP setting. • Check drive's Ethernet settings and diagnostic parameters. • Modify using C125 [Comm Loss Action]. • Replace wiring, Ethernet switch, or control module.
F091 ⁽¹⁾	Encoder Loss	2	Requires differential encoder. One of the 2 encoder channel signals is missing.	<ul style="list-style-type: none"> • Check Wiring. • If P047, P049, P051 [Speed Reference] = 16 "Positioning" and A535 [Motor Fdbk Type] = 5 "Quad Check", swap the Encoder channel inputs or swap any two motor leads. • Replace encoder.
F094	Function Loss	2	"Freeze-Fire" (Function Loss) input is inactive, input to the programmed terminal is open.	Close input to the terminal and cycle power.
F100	Parameter Chksum	2	Drive parameter non-volatile storage is corrupted.	Set P053 [Reset To Defaults] to 2 "Factory Rset".
F101	External Storage	2	External non-volatile storage has failed.	Set P053 [Reset To Defaults] to 2 "Factory Rset".
F105	C Connect Err	2	Control module was disconnected while drive was powered.	Clear fault and verify all parameter settings. Do not remove or install the control module while power is applied.
F106	Incompat C-P	2	The PowerFlex 525 control module does not support power modules with 0.25 HP power rating.	<ul style="list-style-type: none"> • Change to a different power module. • Change to a PowerFlex 523 control module.
F107	Replaced C-P	2	The control module could not recognize the power module. Hardware failure.	<ul style="list-style-type: none"> • Change to a different power module. • Replace control module if changing power module does not work.
F109	Mismatch C-P	2	The control module was mounted to a different drive type power module.	Set P053 [Reset To Defaults] to 3 "Power Reset".
F110	Keypad Membrane	2	Keypad membrane failure / disconnected.	<ul style="list-style-type: none"> • Cycle power. • Replace control module if fault cannot be cleared.
F111 ⁽¹⁾	Safety Hardware	2	Safety input enable hardware malfunction. One of the safety inputs is not enabled.	<ul style="list-style-type: none"> • Check safety input signals. If not using safety, verify and tighten jumper for I/O terminals S1, S2 and S+. • Replace control module if fault cannot be cleared.
F114	uC Failure	2	Microprocessor failure.	<ul style="list-style-type: none"> • Cycle power. • Replace control module if fault cannot be cleared.

Fault Types, Descriptions and Actions

No.	Fault	Type ⁽²⁾	Description	Action
F122	I/O Board Fail	2	Failure has been detected in the drive control and I/O section.	<ul style="list-style-type: none"> Cycle power. Replace drive or control module if fault cannot be cleared.
F125	Flash Update Req	2	The firmware in the drive is corrupt, mismatched, or incompatible with the hardware.	Perform a firmware flash update operation to attempt to load a valid set of firmware.
F126	NonRecoverablErr	2	A non-recoverable firmware or hardware error was detected. The drive was automatically stopped and reset.	<ul style="list-style-type: none"> Clear fault or cycle power to the drive. Replace drive or control module if fault cannot be cleared.
F127	DSIFlashUpdatReq	2	A critical problem with the firmware was detected and the drive is running using backup firmware that only supports DSI communications.	Perform a firmware flash update operation using DSI communications to attempt to load a valid set of firmware.

(1) This fault is not applicable to PowerFlex 523 drives.

(2) See [Fault Types](#) for more information.

(3) This fault may be cleared by the auto-restart routine and will be attempted only once. It ignores the value set in parameter A541 [Auto Rstrt Tries].

Common Symptoms and Corrective Actions

The drive is designed to start from the keypad when shipped. For a basic test of drive operation:

1. Remove all user I/O wire.
2. Verify safety terminals (S1, S2 and S+) jumper is in place and tightened.
3. Verify wire jumper is in place between I/O terminals 01 and 11.
4. Verify that the three jumpers are in their proper default positions on the control board. See [PowerFlex 525 Control I/O Wiring Block Diagram on page 39](#) for more information.
5. Reset default parameter values by setting [P053](#) [Reset Defaults] to 2 “Factory Rset”.
6. If safe to do so for your application, press Start on drive keypad. Drive will run according to the speed potentiometer.

Motor does not Start.

Cause(s)	Indication	Corrective Action
No output voltage to the motor.	None	Check the power circuit. <ul style="list-style-type: none"> Check the supply voltage. Check all fuses and disconnects. Check the motor. <ul style="list-style-type: none"> Verify that the motor is connected properly. Check the control input signals. <ul style="list-style-type: none"> Verify that a Start signal is present. If 2-Wire control is used, verify that either the Run Forward or Run Reverse signal is active, but not both. Verify that I/O Terminal 01 is active. Verify that P046, P048, P050 [Start Source x] matches your configuration. Verify that A544 [Reverse Disable] is not prohibiting movement. Verify that safety inputs (Safety 1 and Safety 2) are active.
Improper boost setting at initial start-up.	None	Set A530 [Boost Select] to 2 "35.0, VT".
Drive is Faulted	Flashing red status light	Clear fault. <ul style="list-style-type: none"> Press Stop if P045 [Stop Mode] is set to a value between "0" and "3". Cycle drive power. Set A551 [Fault Clear] to 1 "Reset Fault" or 2 "Clear Buffer". Cycle digital input if t062, t063, t065..t068 [DigIn TermBlk xx] is set to 13 "Clear Fault".
Incorrect programming. <ul style="list-style-type: none"> P046, P048, P050 [Start Source x] is set incorrectly. 	None	Check setting for b012 [Control Source].
Incorrect input wiring. See page 42 for wiring examples. <ul style="list-style-type: none"> 2 wire control requires Run Forward, Run Reverse or Jog input. 3 wire control requires Start and Stop inputs Stop input is always required. 	None	<ul style="list-style-type: none"> Wire inputs correctly and/or install jumper. If the PowerFlex 525 Safe-Torque-Off function is used, verify that inputs are active. If 2-wire or 3-wire mode is used, verify that t062 [DigIn TermBlk 02] and t063 [DigIn TermBlk 03] are set properly.
Incorrect Sink/Source jumper setting.	None	Set switch to match wiring scheme.

Drive does not Start from Start or Run Inputs wired to the terminal block.

Cause(s)	Indication	Corrective Action
Drive is Faulted	Flashing red status light	Clear fault. <ul style="list-style-type: none"> Press Stop if P045 [Stop Mode] is set to a value between "0" and "3". Cycle drive power. Set A551 [Fault Clear] to 1 "Reset Fault" or 2 "Clear Buffer". Cycle digital input if t062, t063, t065..t068 [DigIn TermBlk xx] is set to 13 "Clear Fault".
Incorrect programming. <ul style="list-style-type: none"> P046, P048, P050 [Start Source x] is set incorrectly. t062, t063 [DigIn TermBlk 02/03] is set incorrectly. 	None	Check parameter settings.
Incorrect input wiring. See page 42 for wiring examples. <ul style="list-style-type: none"> 2 wire control requires Run Forward, Run Reverse or Jog input. 3 wire control requires Start and Stop inputs Stop input is always required. 	None	<ul style="list-style-type: none"> Wire inputs correctly and/or install jumper. If the PowerFlex 525 Safe-Torque-Off function is used, verify that inputs are active.
Incorrect Sink/Source jumper setting.	None	Set switch to match wiring scheme.

Drive does not respond to changes in speed command.

Cause(s)	Indication	Corrective Action
No value is coming from the source of the command.	The drive "Run" indicator is lit and output is 0 Hz.	<ul style="list-style-type: none"> Check b012 [Control Source] for correct source. If the source is an analog input, check wiring and use a meter to check for presence of signal. Check b002 [Commanded Freq] to verify correct command.
Incorrect reference source is being selected by remote device or digital inputs.	None	<ul style="list-style-type: none"> Check b012 [Control Source] for correct source. Check b014 [Dig In Status] to see if inputs are selecting an alternate source. Verify settings for t062, t063, t065-t068 [DigIn TermBlk xx]. Check P047, P049, P051 [Speed Referencecx] for the source of the speed reference. Reprogram as necessary. Review the Speed Reference Control chart on page 46. Verify communications if used.

Motor and/or drive will not accelerate to commanded speed.

Cause(s)	Indication	Corrective Action
Acceleration time is excessive.	None	Reprogram P041 , A442 , A444 , A446 [Accel Time x].
Excess load or short acceleration times force the drive into current limit, slowing or stopping acceleration.	None	<ul style="list-style-type: none"> Compare b003 [Output Current] with A484, A485 [Current Limit x]. Remove excess load or reprogram P041, A442, A444, A446 [Accel Time x]. Check for improper A530 [Boost Select] setting.
Speed command source or value is not as expected.	None	<ul style="list-style-type: none"> Verify b002 [Commanded Freq]. Check b012 [Control Source] for the proper Speed Command.
Programming is preventing the drive output from exceeding limiting values.	None	<ul style="list-style-type: none"> Check P044 [Maximum Freq] to ensure that speed is not limited by programming. Verify programming of A572 [Speed Ratio].
Torque performance does not match motor characteristics.	None	<ul style="list-style-type: none"> Set motor nameplate full load amps in parameter P034 [Motor NP FLA]. Perform P040 [Autotune] "Static Tune" or "Rotate Tune" procedure. Set P039 [Torque Perf Mode] to 0 "V/Hz".

Motor operation is unstable.

Cause(s)	Indication	Corrective Action
Motor data was incorrectly entered.	None	<ol style="list-style-type: none"> Correctly enter motor nameplate data into P031, P032 and P033. Enable A547 [Compensation]. Use A530 [Boost Select] to reduce boost level.

Drive will not reverse motor direction.

Cause(s)	Indication	Corrective Action
Reverse is disabled.	None	Check A544 [Reverse Disable].
Digital input is not selected for reversing control.	None	Check [DigIn TermBlk xx] (See page 82). Choose correct input and program for reversing mode.
Digital input is incorrectly wired.	None	Check input wiring (See page 42).
Motor wiring is improperly phased for reverse.	None	Switch two motor leads.

Drive does not power up.

Cause(s)	Indication	Corrective Action
No input power to drive.	None	<ul style="list-style-type: none"> • Check the power circuit. • Check the supply voltage. • Check all fuses and disconnects.
Control module is not connected properly to power module.	None	<ol style="list-style-type: none"> 1. Remove power. 2. Verify that the control module is properly and fully installed on the power module. 3. Reapply power.

Motor is rotating at zero Hz or slip frequency is not correct.





Cause(s)	Indication	Corrective Action
Incorrect speed calculation.	Improper speed.	<ul style="list-style-type: none"> • Verify P032 [Motor NP Hertz]. • Reduce boost with A530 [Boost Select]. • Set P036 [Motor NP RPM] to motor synchronous speed.

Notes:

Supplemental Drive Information

For information on...	See page...
Certifications	155
Environmental Specifications	156
Technical Specifications	157
Power Specifications	160

Certifications

Certifications	PowerFlex 523	PowerFlex 525
c-UL-us 	Listed to UL508C and CAN/CSA-C22.2 No. 14-05.	
C-Tick  N223	Australian Communications and Media Authority In conformity with the following: Radiocommunications Act: 1992 Radiocommunications Standard: 2008 Radiocommunications Labelling Notice: 2008 Standards applied: EN 61800-3:2004 +A1:2012	
CE 	In conformity with the following European Directives: EMC Directive (2004/108/EC) Low Voltage Directive (2006/95/EC) Standards applied: EN 61800-3:2004 +A1:2012 EN 61800-5-1:2007	
TUV 	Not applicable	TÜV Rheinland Standards applied: EN ISO 13849-1:2008 EN 61800-5-2:2007 EN 61508 PARTS 1-7:2010 EN 62061:2005 EN 60204-1:2009 Certified to ISO 13849-1 SIL2/PLd with embedded Safe-Torque-Off function Meets Functional Safety (FS) when used with embedded Safe-Torque-Off function
ATEX  II (2) GD	Not applicable	Certified to ATEX directive 94/9/EC Group II Category (2) GD Applications with ATEX Approved Motors
KCC	Korean Registration of Broadcasting and Communications Equipment Compliant with the following standards: Article 58-2 of Radio Waves Act, Clause 3	
GOST-R	Russian GOST-R Certificate no. POCC US.ME92.H00040	
AC 156	Tested by Trentec to be compliant with AC156 Acceptance Criteria for Seismic Qualification Testing of Nonstructural Components and 2003 International Building Code for worst-case seismic level for USA excluding site class F	

Certifications	PowerFlex 523	PowerFlex 525
EPRI 	Electric Power Research Institute Certified compliant with the following standards: SEMI F47 IEC 61000-4-34	
Lloyds Register	Not applicable	Lloyd's Register Type Approval Certificate 12/10068(E1)
RoHS	Compliant with the European "Restriction of Hazardous Substances" Directive	

The drive is also designed to meet the appropriate portions of the following specifications:
 NFPA 70 - US National Electrical Code
 NEMA ICS 7.1 - Safety standards for Construction and Guide for Selection, Installation and Operation of Adjustable Speed Drive Systems.

Environmental Specifications

Specifications	PowerFlex 523	PowerFlex 525
Altitude:	See Current Derating Curves on page 17 for derating guidelines.	
Without derating:	1000 m (3300 ft) max.	
With derating:	Up to 4000 m (13,200 ft) max., with the exception of 600V drives at 2000 m (6600 ft) max.	
Max. Surrounding Air Temperature	See Current Derating Curves on page 17 for derating guidelines.	
Without derating:	-20...50 °C (-4...122 °F)	
With derating:	-20...60 °C (-4...140 °F) or -20...70 °C (-4...158 °F) with optional Control Module Fan kit.	
Storage Temperature:		
Frame A...D:	-40...85 °C (-40...185 °F)	
Frame E:	-40...70 °C (-40...158 °F)	

Atmosphere:

IMPORTANT

Drive **must not** be installed in an area where the ambient atmosphere contains volatile or corrosive gas, vapors or dust. If the drive is not going to be installed for a period of time, it must be stored in an area where it will not be exposed to a corrosive atmosphere.

Relative Humidity:	0...95% noncondensing
Shock:	Complies with IEC 60068-2-27
Vibration:	Complies with IEC 60068-2-6:1995

Frame Size	Operating and Nonoperating		Nonoperating (Transportation)	
	Force (Shock/Vibration)	Mounting Type	Force (Shock/Vibration)	Mounting Type
A	15 g / 2 g	DIN rail or screw	30 g / 2.5 g	Screw only
B	15 g / 2 g	DIN rail or screw	30 g / 2.5 g	Screw only
C	15 g / 2 g	DIN rail or screw	30 g / 2.5 g	Screw only
D	15 g / 2 g	Screw only	30 g / 2.5 g	Screw only
E	15 g / 1.5 g	Screw only	30 g / 2.5 g	Screw only

Conformal Coating:	Complies with: IEC 60721-3-3 to level 3C2 (chemical and gases only)
Surrounding Environment Pollution Degree	See Pollution Degree Ratings According to EN 61800-5-1 on page 49 for descriptions.
Pollution Degree 1 & 2:	All enclosures acceptable.
Sound Pressure Level (A-weighted)	Measurements are taken 1 m from the drive.
Frame A & B:	Maximum 53 dBA
Frame C:	Maximum 57 dBA
Frame D:	Maximum 64 dBA
Frame E:	Maximum 68 dBA

Technical Specifications

Protection

Specifications	PowerFlex 523	PowerFlex 525
Bus Overvoltage Trip		
100...120V AC Input:	405V DC bus (equivalent to 150V AC incoming line)	
200...240V AC Input:	405V DC bus (equivalent to 290V AC incoming line)	
380...480V AC Input:	810V DC bus (equivalent to 575V AC incoming line)	
525...600V AC Input:	1005V DC bus (equivalent to 711V AC incoming line)	
Bus Undervoltage Trip		
100...120V AC Input:	190V DC bus (equivalent to 75V AC incoming line)	
200...240V AC Input:	190V DC bus (equivalent to 150V AC incoming line)	
380...480V AC Input:	390V DC bus (equivalent to 275V AC incoming line)	
525...600V AC Input		
P038 = 3 "600V":	487V DC bus (equivalent to 344V AC incoming line)	
P038 = 2 "480V":	390V DC bus (equivalent to 275V AC incoming line)	
Power Ride-Thru:	100 ms	
Logic Control Ride-Thru:	0.5 s minimum, 2 s typical	
Electronic Motor Overload Protection:	Provides class 10 motor overload protection according to NEC article 430 and motor over-temperature protection according to NEC article 430.126 (A) (2). UL 508C File 29572.	
Overcurrent:	200% hardware limit, 300% instantaneous fault	
Ground Fault Trip:	Phase-to-ground on drive output	
Short Circuit Trip:	Phase-to-phase on drive output	

Electrical

Specifications	PowerFlex 523	PowerFlex 525
Voltage Tolerance:	-15% / +10%	
Frequency Tolerance:	47...63 Hz	
Input Phases:	Three-phase input provides full rating. Single-phase input provides 35% rating on three-phase drives.	
Displacement Power Factor:	0.98 across entire speed range	
Maximum Short Circuit Rating:	100,000 Amps Symmetrical	
Actual Short Circuit Rating:	Determined by AIC Rating of installed fuse/circuit breaker	
Transistor Type:	Isolated Gate Bipolar Transistor (IGBT)	
Internal DC Bus Choke	Only for Frame E drive ratings	
200...240V AC Input:	11 kW (15 HP)	
380...480V AC Input:	15...18.5 kW (20...25 HP) – Heavy Duty	
525...600V AC Input:	15...18.5 kW (20...25 HP) – Heavy Duty	

Control

Specifications	PowerFlex 523	PowerFlex 525
Method	Sinusoidal PWM, Volts/Hertz, Sensorless Vector Control, Economizer SVC motor control and Closed Loop Velocity Vector Control (Closed Loop Velocity Vector Control is not applicable to PowerFlex 523 drives)	
Carrier Frequency	2...16 kHz, Drive rating based on 4 kHz	
Frequency Accuracy		
Digital Input:	Within $\pm 0.05\%$ of set output frequency	
Analog Input:	Within 0.5% of maximum output frequency, 10-Bit resolution	
Analog Output:	–	$\pm 2\%$ of full scale, 10-Bit resolution
Performance		
V/Hz (Volts per Hertz):	$\pm 1\%$ of base speed across a 60:1 speed range	
SVC (Sensorless Vector):	$\pm 0.5\%$ of base speed across a 100:1 speed range	
SVC Economizer:	$\pm 0.5\%$ of base speed across a 100:1 speed range	
VVC (Velocity Vector Control):	$\pm 0.5\%$ of base speed across a 60:1 speed range – Not applicable to PowerFlex 523 drives	

Specifications	PowerFlex 523	PowerFlex 525
Performance with Encoder SVC (Sensorless Vector):	–	±0.1% of base speed across a 100:1 speed range
SVC Economizer:		±0.1% of base speed across a 100:1 speed range
VVC (Velocity Vector Control):		±0.1% of base speed across a 1000:1 speed range
Output Voltage Range:	0V to rated motor voltage	
Output Frequency Range:	0...500 Hz (programmable)	
Efficiency:	97.5% (typical)	
Stop Modes:	Multiple programmable stop modes including – Ramp, Coast, DC-Brake, and Ramp-to-Stop	
Accel/Decel:	Four independently programmable accel and decel times. Each time may be programmed from 0...600 s in 0.01 s increments.	
Intermittent Overload Normal Duty:	110% Overload capability for up to 60 s, 150% for up to 3 s Applies for power rating above 15 kW (20 HP) only. Based on 480V drive rating.	
Heavy Duty:	150% Overload capability for up to 60 s, 180% for up to 3 s	

Control Inputs

Specifications	PowerFlex 523	PowerFlex 525	
Digital	Bandwidth:	10 Rad/s for open and closed loop	
	Quantity:	(1) Dedicated for stop (4) Programmable	(1) Dedicated for stop (6) Programmable
	Current:	6 mA	
	Type Source Mode (SRC): Sink Mode (SNK):	18...24V = ON, 0...6V = OFF 0...6V = ON, 18...24V = OFF	
	Pulse Train Quantity: Input Signal: Input Frequency: Current Consumption:	(1) Shared with one of the programmable digital input terminals. Transistor contact (open collector) 0...100 kHz 7 mA @ 24V DC maximum	
Analog:	Quantity:	(2) Isolated, 0-10V and 4-20mA	(2) Isolated, -10-10V and 4-20mA
	Specification Resolution: 0-10V DC Analog: 4-20mA Analog: External Pot:	10-bit 100k ohm input impedance 250 ohm input impedance 1...10k ohm, 2 W minimum	

Control Outputs

Specifications	PowerFlex 523	PowerFlex 525	
Relay:	Quantity:	(1) Programmable Form C	(2) 1 Programmable Form A and 1 Programmable Form B
	Specification Resistive Rating: Inductive Rating:	3.0 A @ 30V DC, 3.0 A @ 125V, 3.0 A @ 240V AC 0.5 A @ 30V DC, 0.5 A @ 125V, 0.5 A @ 240V AC	

Specifications		PowerFlex 523	PowerFlex 525
Opto:	Quantity:	–	(2) Programmable
	Specification:		30V DC, 50 mA Non-inductive
Analog	Quantity:	–	(1) Non-Isolated 0-10V or 4-20 mA
	Specification Resolution: 0-10V DC Analog: 4-20 mA Analog:		10-bit 1 k ohm minimum 525 ohm maximum

Encoder

Specifications	PowerFlex 523	PowerFlex 525
Type:	–	Incremental, dual channel
Supply:		12V, 250 mA
Quadrature:		90 °, ±27 ° @ 25 °C
Duty Cycle:		50%, +10%
Requirements:		Encoders must be line driver type, quadrature (dual channel) or pulse (single channel), 3.5...26V DC output, single-ended or differential and capable of supplying a minimum of 10 mA per channel. Allowable input is DC up to a maximum frequency of 250 kHz. The encoder I/O automatically scales to allow 5V, 12V and 24V DC nominal voltages.

Power Specifications

Watts Loss

PowerFlex 520-Series Estimated Watts Loss (Rated Load, Speed & PWM)

Voltage	Output Current (A)	Total Watts Loss
100...120V, 50/60 Hz 1-Phase	1.6	20.0
	2.5	27.0
	4.8	53.0
	6.0	67.0
200...240V, 50/60 Hz 1-Phase	1.6	20.0
	2.5	29.0
	4.8	50.0
	8.0	81.0
	11.0	111.0
200...240V, 50/60 Hz 1-Phase w/ EMC Filter	1.6	20.0
	2.5	29.0
	4.8	53.0
	8.0	84.0
	11.0	116.0
200...240V, 50/60 Hz 3-Phase	1.6	20.0
	2.5	29.0
	5.0	50.0
	8.0	79.0
	11.0	107.0
	17.5	148.0
	24.0	259.0
	32.2	323.0
	48.3	584.0
	62.1	708.0
380...480V, 50/60 Hz 3-Phase	1.4	27.0
	2.3	37.0
	4.0	62.0
	6.0	86.0
	10.5	129.0
	13.0	170.0
	17.0	221.0
	24.0	303.0
	30.0	387.0
	380...480V, 50/60 Hz 3-Phase w/ EMC Filter	1.4
2.3		37.0
4.0		63.0
6.0		88.0
10.5		133.0
13.0		175.0
17.0		230.0
24.0		313.0
30.0		402.0
37.0		602.0
43.0	697.0	

PowerFlex 520-Series Estimated Watts Loss (Rated Load, Speed & PWM)

Voltage	Output Current (A)	Total Watts Loss
525...600V, 50/60 Hz 3-Phase	0.9	22.0
	1.7	32.0
	3.0	50.0
	4.2	65.0
	6.6	95.0
	9.9	138.0
	12.0	164.0
	19.0	290.0
	22.0	336.0
	27.0	466.0
	32.0	562.0

Input Current Scaling (Optional)

You can use a higher drive rating by scaling the input current based on the output current required for your application.

PowerFlex 520-Series Input Current Scaled By Motor Current

PowerFlex 523	PowerFlex 525	Output				Input			
Catalog Number	Catalog Number	1	2	3	4	5	6	7	8
100...120V AC (-15%, +10%) – 1-Phase Input, 0...230V 3-Phase Output									
25A-V1P6N104	–	1.6	1.3	1.0	0.8	6.4	5.2	4.0	3.2
25A-V2P5N104	25B-V2P5N104	2.5	2.0	1.6	1.3	9.6	7.7	6.2	4.8
25A-V4P8N104	25B-V4P8N104	4.8	3.8	3.1	2.4	19.2	15.4	12.5	9.6
25A-V6P0N104	25B-V6P0N104	6.0	4.8	3.9	3.0	24.0	19.2	15.6	12.0
200...240V AC (-15%, +10%) – 1-Phase Input, 0...230V 3-Phase Output									
25A-A1P6N104	–	1.6	1.3	1.0	0.8	5.3	4.3	3.4	2.7
25A-A2P5N104	25B-A2P5N104	2.5	2.0	1.6	1.3	6.5	5.2	4.2	3.3
25A-A4P8N104	25B-A4P8N104	4.8	3.8	3.1	2.4	10.7	8.6	7.0	5.4
25A-A8P0N104	25B-A8P0N104	8.0	6.4	5.2	4.0	18.0	14.4	11.7	9.0
25A-A011N104	25B-A011N104	11.0	8.8	7.2	5.5	22.9	18.3	14.9	11.5
200...240V AC (-15%, +10%) – 1-Phase Input with EMC Filter, 0...230V 3-Phase Output									
25A-A1P6N114	–	1.6	1.3	1.0	0.8	5.3	4.3	3.4	2.7
25A-A2P5N114	25B-A2P5N114	2.5	2.0	1.6	1.3	6.5	5.2	4.2	3.3
25A-A4P8N114	25B-A4P8N114	4.8	3.8	3.1	2.4	10.7	8.6	7.0	5.4
25A-A8P0N114	25B-A8P0N114	8.0	6.4	5.2	4.0	18.0	14.4	11.7	9.0
25A-A011N114	25B-A011N114	11.0	8.8	7.2	5.5	22.9	18.3	14.9	11.5
200...240V AC (-15%, +10%) – 3-Phase Input, 0...230V 3-Phase Output									
25A-B1P6N104	–	1.6	1.3	1.0	0.8	1.9	1.5	1.2	1.0
25A-B2P5N104	25B-B2P5N104	2.5	2.0	1.6	1.3	2.7	2.2	1.8	1.4
25A-B5P0N104	25B-B5P0N104	5.0	4.0	3.2	2.5	5.8	4.6	3.8	2.9
25A-B8P0N104	25B-B8P0N104	8.0	6.4	5.2	4.0	9.5	7.6	6.2	4.8
25A-B011N104	25B-B011N104	11.0	8.8	7.2	5.5	13.8	11.0	9.0	6.9
25A-B017N104	25B-B017N104	17.5	14.0	11.4	8.8	21.1	16.9	13.7	10.6
25A-B024N104	25B-B024N104	24.0	19.2	15.6	12.0	26.6	21.3	17.3	13.3
25A-B032N104	25B-B032N104	32.2	25.8	20.9	16.1	34.8	27.8	22.6	17.4
25A-B048N104	25B-B048N104	48.3	38.6	31.4	24.2	44.0	35.2	28.6	22.0
25A-B062N104	25B-B062N104	62.1	49.7	40.4	31.1	56.0	44.8	36.4	28.0

PowerFlex 520-Series Input Current Scaled By Motor Current

PowerFlex 523	PowerFlex 525	Output				Input			
Catalog Number	Catalog Number	1	2	3	4	5	6	7	8
380...480V AC (-15%, +10%) – 3-Phase Input, 0...460V 3-Phase Output									
25A-D1P4N104	25B-D1P4N104	1.4	1.1	0.9	0.7	1.9	1.5	1.2	1.0
25A-D2P3N104	25B-D2P3N104	2.3	1.8	1.5	1.2	3.2	2.6	2.1	1.6
25A-D4P0N104	25B-D4P0N104	4.0	3.2	2.6	2.0	5.7	4.6	3.7	2.9
25A-D6P0N104	25B-D6P0N104	6.0	4.8	3.9	3.0	7.5	6.0	4.9	3.8
25A-D010N104	25B-D010N104	10.5	8.4	6.8	5.3	13.8	11.0	9.0	6.9
25A-D013N104	25B-D013N104	13.0	10.4	8.5	6.5	15.4	12.3	10.0	7.7
25A-D017N104	25B-D017N104	17.0	13.6	11.1	8.5	18.4	14.7	12.0	9.2
25A-D024N104	25B-D024N104	24.0	19.2	15.6	12.0	26.4	21.1	17.2	13.2
25A-D030N104	25B-D030N104	30.0	24.0	19.5	15.0	33.0	26.4	21.5	16.5
380...480V AC (-15%, +10%) – 3-Phase Input with EMC Filter, 0...460V 3-Phase Output									
25A-D1P4N114	25B-D1P4N114	1.4	1.1	0.9	0.7	1.9	1.5	1.2	1.0
25A-D2P3N114	25B-D2P3N114	2.3	1.8	1.5	1.2	3.2	2.6	2.1	1.6
25A-D4P0N114	25B-D4P0N114	4.0	3.2	2.6	2.0	5.7	4.6	3.7	2.9
25A-D6P0N114	25B-D6P0N114	6.0	4.8	3.9	3.0	7.5	6.0	4.9	3.8
25A-D010N114	25B-D010N114	10.5	8.4	6.8	5.3	13.8	11.0	9.0	6.9
25A-D013N114	25B-D013N114	13.0	10.4	8.5	6.5	15.4	12.3	10.0	7.7
25A-D017N114	25B-D017N114	17.0	13.6	11.1	8.5	18.4	14.7	12.0	9.2
25A-D024N114	25B-D024N114	24.0	19.2	15.6	12.0	26.4	21.1	17.2	13.2
25A-D030N114	25B-D030N114	30.0	24.0	19.5	15.0	33.0	26.4	21.5	16.5
25A-D037N114	25B-D037N114	37.0	29.6	24.1	18.5	33.7	27.0	21.9	16.9
25A-D043N114	25B-D043N114	43.0	34.4	28.0	21.5	38.9	31.1	25.3	19.5
525...600V AC (-15%, +10%) – 3-Phase Input, 0...575V 3-Phase Output									
25A-E0P9N104	25B-E0P9N104	0.9	0.7	0.6	0.5	1.2	1.0	0.8	0.6
25A-E1P7N104	25B-E1P7N104	1.7	1.4	1.1	0.9	2.3	1.8	1.5	1.2
25A-E3P0N104	25B-E3P0N104	3.0	2.4	2.0	1.5	3.8	3.0	2.5	1.9
25A-E4P2N104	25B-E4P2N104	4.2	3.4	2.7	2.1	5.3	4.2	3.4	2.7
25A-E6P6N104	25B-E6P6N104	6.6	5.3	4.3	3.3	8.0	6.4	5.2	4.0
25A-E9P9N104	25B-E9P9N104	9.9	7.9	6.4	5.0	11.2	9.0	7.3	5.6
25A-E012N104	25B-E012N104	12.0	9.6	7.8	6.0	13.5	10.8	8.8	6.8
25A-E019N104	25B-E019N104	19.0	15.2	12.4	9.5	24.0	19.2	15.6	12.0
25A-E022N104	25B-E022N104	22.0	17.6	14.3	11.0	27.3	21.8	17.7	13.7
25A-E027N104	25B-E027N104	27.0	21.6	17.6	13.5	24.7	19.8	16.1	12.4
25A-E032N104	25B-E032N104	32.0	25.6	20.8	16.0	29.2	23.4	19.0	14.6

Accessories and Dimensions

Product Selection

Catalog Number Description

25B	-	V	2P5	N	1	0	4
Drive		Voltage Rating	Rating	Enclosure	HIM	Emission Class	Version

PowerFlex 520-Series Drive Ratings

Output Ratings					Input Voltage Range	Frame Size	PowerFlex 523 Catalog No.	PowerFlex 525 Catalog No.
Normal Duty		Heavy Duty		Output Current (A)				
HP	kW	HP	kW					
100...120V AC (-15%, +10%) – 1-Phase Input, 0...230V 3-Phase Output								
0.25	0.2	0.25	0.2	1.6	85...132	A	25A-V1P6N104 ⁽²⁾	–
0.5	0.4	0.5	0.4	2.5	85...132	A	25A-V2P5N104	25B-V2P5N104
1.0	0.75	1.0	0.75	4.8	85...132	B	25A-V4P8N104	25B-V4P8N104
1.5	1.1	1.5	1.1	6.0	85...132	B	25A-V6P0N104	25B-V6P0N104
200...240V AC (-15%, +10%) – 1-Phase Input, 0...230V 3-Phase Output								
0.25	0.2	0.25	0.2	1.6	170...264	A	25A-A1P6N104 ⁽²⁾	–
0.5	0.4	0.5	0.4	2.5	170...264	A	25A-A2P5N104	25B-A2P5N104
1.0	0.75	1.0	0.75	4.8	170...264	A	25A-A4P8N104	25B-A4P8N104
2.0	1.5	2.0	1.5	8.0	170...264	B	25A-A8P0N104	25B-A8P0N104
3.0	2.2	3.0	2.2	11.0	170...264	B	25A-A011N104	25B-A011N104
200...240V AC (-15%, +10%) – 1-Phase Input with EMC Filter, 0...230V 3-Phase Output								
0.25	0.2	0.25	0.2	1.6	170...264	A	25A-A1P6N114	–
0.5	0.4	0.5	0.4	2.5	170...264	A	25A-A2P5N114	25B-A2P5N114
1.0	0.75	1.0	0.75	4.8	170...264	A	25A-A4P8N114	25B-A4P8N114
2.0	1.5	2.0	1.5	8.0	170...264	B	25A-A8P0N114	25B-A8P0N114
3.0	2.2	3.0	2.2	11.0	170...264	B	25A-A011N114	25B-A011N114
200...240V AC (-15%, +10%) – 3-Phase Input, 0...230V 3-Phase Output								
0.25	0.2	0.25	0.2	1.6	170...264	A	25A-B1P6N104 ⁽²⁾	–
0.5	0.4	0.5	0.4	2.5	170...264	A	25A-B2P5N104	25B-B2P5N104
1.0	0.75	1.0	0.75	5.0	170...264	A	25A-B5P0N104	25B-B5P0N104
2.0	1.5	2.0	1.5	8.0	170...264	A	25A-B8P0N104	25B-B8P0N104
3.0	2.2	3.0	2.2	11.0	170...264	A	25A-B011N104	25B-B011N104
5.0	4.0	5.0	4.0	17.5	170...264	B	25A-B017N104	25B-B017N104
7.5	5.5	7.5	5.5	24.0	170...264	C	25A-B024N104	25B-B024N104
10.0	7.5	10.0	7.5	32.2	170...264	D	25A-B032N104	25B-B032N104
15.0	11.0	10.0	7.5	48.3	170...264	E	25A-B048N104	25B-B048N104
20.0	15.0	15.0	11.0	62.1	170...264	E	25A-B062N104	25B-B062N104
380...480V AC (-15%, +10%) – 3-Phase Input, 0...460V 3-Phase Output⁽¹⁾								
0.5	0.4	0.5	0.4	1.4	323...528	A	25A-D1P4N104 ⁽²⁾	25B-D1P4N104 ⁽²⁾
1.0	0.75	1.0	0.75	2.3	323...528	A	25A-D2P3N104	25B-D2P3N104
2.0	1.5	2.0	1.5	4.0	323...528	A	25A-D4P0N104	25B-D4P0N104
3.0	2.2	3.0	2.2	6.0	323...528	A	25A-D6P0N104	25B-D6P0N104
5.0	4.0	5.0	4.0	10.5	323...528	B	25A-D010N104	25B-D010N104

PowerFlex 520-Series Drive Ratings

Output Ratings					Input Voltage Range	Frame Size	PowerFlex 523 Catalog No.	PowerFlex 525 Catalog No.
Normal Duty		Heavy Duty		Output Current (A)				
HP	kW	HP	kW					
7.5	5.5	7.5	5.5	13.0	323...528	C	25A-D013N104	25B-D013N104
10.0	7.5	10.0	7.5	17.0	323...528	C	25A-D017N104	25B-D017N104
15.0	11.0	15.0	11.0	24.0	323...528	D	25A-D024N104	25B-D024N104
20.0	15.0	15.0	11.0	30.0	323...528	D	25A-D030N104	25B-D030N104
380...480V AC (-15%, +10%) – 3-Phase Input with EMC Filter, 0...460V 3-Phase Output								
0.5	0.4	0.5	0.4	1.4	323...528	A	25A-D1P4N114	25B-D1P4N114
1.0	0.75	1.0	0.75	2.3	323...528	A	25A-D2P3N114	25B-D2P3N114
2.0	1.5	2.0	1.5	4.0	323...528	A	25A-D4P0N114	25B-D4P0N114
3.0	2.2	3.0	2.2	6.0	323...528	A	25A-D6P0N114	25B-D6P0N114
5.0	4.0	5.0	4.0	10.5	323...528	B	25A-D010N114	25B-D010N114
7.5	5.5	7.5	5.5	13.0	323...528	C	25A-D013N114	25B-D013N114
10.0	7.5	10.0	7.5	17.0	323...528	C	25A-D017N114	25B-D017N114
15.0	11.0	15.0	11.0	24.0	323...528	D	25A-D024N114	25B-D024N114
20.0	15.0	15.0	11.0	30.0	323...528	D	25A-D030N114	25B-D030N114
25.0	18.5	20.0	15.0	37.0	323...528	E	25A-D037N114	25B-D037N114
30.0	22.0	25.0	18.5	43.0	323...528	E	25A-D043N114	25B-D043N114
525...600V AC (-15%, +10%) – 3-Phase Input, 0...575V 3-Phase Output								
0.5	0.4	0.5	0.4	0.9	446...660	A	25A-E0P9N104 ⁽²⁾	25B-E0P9N104 ⁽²⁾
1.0	0.75	1.0	0.75	1.7	446...660	A	25A-E1P7N104	25B-E1P7N104
2.0	1.5	2.0	1.5	3.0	446...660	A	25A-E3P0N104	25B-E3P0N104
3.0	2.2	3.0	2.2	4.2	446...660	A	25A-E4P2N104	25B-E4P2N104
5.0	4.0	5.0	4.0	6.6	446...660	B	25A-E6P6N104	25B-E6P6N104
7.5	5.5	7.5	5.5	9.9	446...660	C	25A-E9P9N104	25B-E9P9N104
10.0	7.5	10.0	7.5	12.0	446...660	C	25A-E012N104	25B-E012N104
15.0	11.0	15.0	11.0	19.0	446...660	D	25A-E019N104	25B-E019N104
20.0	15.0	15.0	11.0	22.0	446...660	D	25A-E022N104	25B-E022N104
25.0	18.5	20.0	15.0	27.0	446...660	E	25A-E027N104	25B-E027N104
30.0	22.0	25.0	18.5	32.0	446...660	E	25A-E032N104	25B-E032N104

- (1) A non-filtered drive is not available for 380...480V AC 25 HP (18.5 kW) and 30 HP (22.0 kW) ratings. Filtered drives are available, however you must verify that the application will support a filtered drive.
- (2) These drive ratings do not come with a heatsink cooling fan and are in accordance with design specifications.

Dynamic Brake Resistors

Drive Ratings Input Voltage	HP	kW	Minimum Resistance	Resistance	Catalog No. ⁽¹⁾⁽²⁾
			Ω ±10%	Ω ±5%	
100...120V 50/60 Hz 1-Phase	0.25	0.2	56	91	AK-R2-091P500
	0.5	0.4	56	91	AK-R2-091P500
	1.0	0.75	56	91	AK-R2-091P500
	1.5	1.1	41	91	AK-R2-091P500
200...240V 50/60 Hz 1-Phase	0.25	0.2	56	91	AK-R2-091P500
	0.5	0.4	56	91	AK-R2-091P500
	1.0	0.75	56	91	AK-R2-091P500
	2.0	1.5	41	91	AK-R2-091P500
	3.0	2.2	32	47	AK-R2-047P500

Dynamic Brake Resistors

Drive Ratings			Minimum Resistance $\Omega \pm 10\%$	Resistance $\Omega \pm 5\%$	Catalog No. ⁽¹⁾⁽²⁾
Input Voltage	HP	kW			
200...240V 50/60 Hz 3-Phase	0.25	0.2	56	91	AK-R2-091P500
	0.5	0.4	56	91	AK-R2-091P500
	1.0	0.75	56	91	AK-R2-091P500
	2.0	1.5	41	91	AK-R2-091P500
	3.0	2.2	32	47	AK-R2-047P500
	5.0	4.0	18	47	AK-R2-047P500
	7.5	5.5	16	30	AK-R2-030P1K2
	10.0	7.5	14	30	AK-R2-030P1K2
	15.0	11.0	14	15	AK-R2-030P1K2 ⁽³⁾
	20.0	15.0	10	15	AK-R2-030P1K2 ⁽³⁾
380...480V 50/60 Hz 3-Phase	0.5	0.4	89	360	AK-R2-360P500
	1.0	0.75	89	360	AK-R2-360P500
	2.0	1.5	89	360	AK-R2-360P500
	3.0	2.2	89	120	AK-R2-120P1K2
	5.0	4.0	47	120	AK-R2-120P1K2
	7.5	5.5	47	120	AK-R2-120P1K2
	10.0	7.5	47	120	AK-R2-120P1K2
	15.0	11.0	43	60	AK-R2-120P1K2 ⁽³⁾
	20.0	15.0	43	60	AK-R2-120P1K2 ⁽³⁾
	25.0	18.5	27	40	AK-R2-120P1K2 ⁽⁴⁾
525...600V 50/60 Hz 3-Phase	0.5	0.4	112	360	AK-R2-360P500
	1.0	0.75	112	360	AK-R2-360P500
	2.0	1.5	112	360	AK-R2-360P500
	3.0	2.2	112	120	AK-R2-120P1K2
	5.0	4.0	86	120	AK-R2-120P1K2
	7.5	5.5	59	120	AK-R2-120P1K2
	10.0	7.5	59	120	AK-R2-120P1K2
	15.0	11.0	59	60	AK-R2-120P1K2 ⁽³⁾
	20.0	15.0	59	60	AK-R2-120P1K2 ⁽³⁾
	25.0	18.5	53	60	AK-R2-120P1K2 ⁽³⁾
30.0	22.0	34	40	AK-R2-120P1K2 ⁽⁴⁾	

(1) The resistors listed in this tables are rated for 5% duty cycle.

(2) Use of Rockwell Automation resistors is always recommended. The resistors listed have been carefully selected for optimizing performance in a variety of applications. Alternative resistors may be used, however, care must be taken when making a selection. See the PowerFlex Dynamic Braking Resistor Calculator, publication PFLEX-AT001.

(3) Requires two resistors wired in parallel.

(4) Requires three resistors wired in parallel.

EMC Line Filters

Drive Ratings				Frame Size	Catalog No.
Input Voltage	HP	kW	Current (A)		
100...120V 50/60 Hz 1-Phase	0.25	0.2	1.6	A	25-RF011-AL
	0.5	0.4	2.5	A	25-RF011-AL
	1.0	0.75	4.8	B	25-RF023-BL
	1.5	1.1	6.0	B	25-RF023-BL

EMC Line Filters

Drive Ratings				Frame Size	Catalog No.
Input Voltage	HP	kW	Current (A)		
200...240V 50/60 Hz 1-Phase	0.25	0.2	1.6	A	25-RF011-AL
	0.5	0.4	2.5	A	25-RF011-AL
	1.0	0.75	4.8	A	25-RF011-AL
	2.0	1.5	8.0	B	25-RF023-BL
	3.0	2.2	11.0	B	25-RF023-BL
200...240V 50/60 Hz 3-Phase	0.25	0.2	1.6	A	25-RF014-AL
	0.5	0.4	2.5	A	25-RF014-AL
	1.0	0.75	5.0	A	25-RF014-AL
	2.0	1.5	8.0	A	25-RF014-AL
	3.0	2.2	11.0	A	25-RF014-AL
	5.0	4.0	17.5	B	25-RF021-BL
	7.5	5.5	24.0	C	25-RF027-CL
	10.0	7.5	32.2	D	25-RF035-DL
	15.0	11.0	48.3	E	25-RF056-EL
20.0	15.0	62.1	E	25-RF056-EL	
380...480V 50/60 Hz 3-Phase	0.5	0.4	1.4	A	25-RF7P5-AL
	1.0	0.75	2.3	A	25-RF7P5-AL
	2.0	1.5	4.0	A	25-RF7P5-AL
	3.0	2.2	6.0	A	25-RF7P5-AL
	5.0	4.0	10.5	B	25-RF014-BL
	7.5	5.5	13.0	C	25-RF018-CL
	10.0	7.5	17.0	C	25-RF018-CL
	15.0	11.0	24.0	D	25-RF033-DL
	20.0	15.0	30.0	D	25-RF033-DL
	25.0	18.5	37.0	E	25-RF039-EL
30.0	22.0	43.0	E	25-RF039-EL ⁽¹⁾	
525...600V 50/60 Hz 3-Phase	0.5	0.4	0.9	A	25-RF8P0-BL ⁽²⁾
	1.0	0.75	1.7	A	25-RF8P0-BL ⁽²⁾
	2.0	1.5	3.0	A	25-RF8P0-BL ⁽²⁾
	3.0	2.2	4.2	A	25-RF8P0-BL ⁽²⁾
	5.0	4.0	6.6	B	25-RF8P0-BL
	7.5	5.5	9.9	C	25-RF014-CL
	10.0	7.5	12.0	C	25-RF014-CL
	15.0	11.0	19.0	D	25-RF027-DL
	20.0	15.0	22.0	D	25-RF027-DL
	25.0	18.5	27.0	E	25-RF029-EL
30.0	22.0	32.0	E	25-RF029-EL ⁽¹⁾	

(1) EMC Line Filter size is based on the input current of the drive. See the tables on [page 25](#) and [page 26](#) for more information.

(2) This 600V drive rating needs to be matched with a frame B EMC Line Filter.

EMC Plates

Item	Description	Frame Size	Catalog No.
EMC Plate	Optional grounding plate for shielded cables.	A	25-EMC1-FA
		B	25-EMC1-FB
		C	25-EMC1-FC
		D	25-EMC1-FD
		E	25-EMC1-FE

Human Interface Module (HIM) Option Kits and Accessories

Item	Description	Catalog No.
LCD Display, Remote Panel Mount	Digital speed control CopyCat capable IP66 (NEMA Type 4X/12) indoor use only Includes 2.9 meter cable	22-HIM-C2S
LCD Display, Remote Handheld	Digital speed control Full numeric keyboard CopyCat capable IP 30 (NEMA Type 1) Includes 1.0 meter cable Panel mount with optional Bezel Kit	22-HIM-A3
Bezel Kit	Panel mount for LCD Display, Remote Handheld unit, IP 30 (NEMA Type 1) Includes 2.0 m DSI cable	22-HIM-B1
DSI HIM Cable (DSI HIM to RJ45 cable)	1.0 m (3.3 ft)	22-HIM-H10
	2.9 m (9.51 ft)	22-HIM-H30

IP 30/NEMA 1/UL Type 1 Kit

Item	Description	Frame Size	Catalog No.
IP 30/NEMA 1/UL Type 1 Kit	Field installed kit. Converts drive to IP 30/NEMA 1/UL Type 1 enclosure. Includes conduit box with mounting screws and plastic top panel.	A	25-JBAA
		B	25-JBAB
		C	25-JBAC
		D	25-JBAD
		E	25-JBAE

Control Module Fan Kit

Item	Description	Frame Size	Catalog No.
Control Module Fan Kit	For use with drive in environments with ambient temperatures up to 70 °C or horizontal mounting.	A...D	25-FAN1-70C
		E	25-FAN2-70C

Incremental Encoder Input Option

Item	Description	Catalog No.
Incremental Encoder	Incremental encoder input option board.	25-ENC-1

Bulletin 160 to PowerFlex 520-Series Mounting Adapter Plate

Item	Description	B160 Frame Size	Catalog No.
Mounting Adapter Plate	For use with drive when replacing Bulletin 160 drives in existing installations to a PowerFlex 520-Series drive. Select the catalog number based on the frame size of your Bulletin 160 drive.	A	25-MAP-FA
		B	25-MAP-FB

Replacement Parts

PowerFlex 520-Series Power Module

Item	Description
PowerFlex 520-Series Power Module	Replacement power module for use with PowerFlex 520-Series drives. Includes: <ul style="list-style-type: none"> • Power Module • Power Module Front Cover • Power Terminal Guard • Heatsink Fan

Output Ratings					Input Voltage Range	Frame Size	Catalog No.
Normal Duty		Heavy Duty		Output Current (A)			
HP	kW	HP	kW				
100...120V AC (-15%, +10%) – 1-Phase Input, 0...230V 3-Phase Output							
0.25	0.2	0.25	0.2	1.6	85...132	A	25-PM1-V1P6
0.5	0.4	0.5	0.4	2.5	85...132	A	25-PM1-V2P5
1.0	0.75	1.0	0.75	4.8	85...132	B	25-PM1-V4P8
1.5	1.1	1.5	1.1	6.0	85...132	B	25-PM1-V6P0
200...240V AC (-15%, +10%) – 1-Phase Input, 0...230V 3-Phase Output							
0.25	0.2	0.25	0.2	1.6	170...264	A	25-PM1-A1P6
0.5	0.4	0.5	0.4	2.5	170...264	A	25-PM1-A2P5
1.0	0.75	1.0	0.75	4.8	170...264	A	25-PM1-A4P8
2.0	1.5	2.0	1.5	8.0	170...264	B	25-PM1-A8P0
3.0	2.2	3.0	2.2	11.0	170...264	B	25-PM1-A011
200...240V AC (-15%, +10%) – 1-Phase Input with EMC Filter, 0...230V 3-Phase Output							
0.25	0.2	0.25	0.2	1.6	170...264	A	25-PM2-A1P6
0.5	0.4	0.5	0.4	2.5	170...264	A	25-PM2-A2P5
1.0	0.75	1.0	0.75	4.8	170...264	A	25-PM2-A4P8
2.0	1.5	2.0	1.5	8.0	170...264	B	25-PM2-A8P0
3.0	2.2	3.0	2.2	11.0	170...264	B	25-PM2-A011
200...240V AC (-15%, +10%) – 3-Phase Input, 0...230V 3-Phase Output							
0.25	0.2	0.25	0.2	1.6	170...264	A	25-PM1-B1P6
0.5	0.4	0.5	0.4	2.5	170...264	A	25-PM1-B2P5
1.0	0.75	1.0	0.75	5.0	170...264	A	25-PM1-B5P0
2.0	1.5	2.0	1.5	8.0	170...264	A	25-PM1-B8P0
3.0	2.2	3.0	2.2	11.0	170...264	A	25-PM1-B011
5.0	4.0	5.0	4.0	17.5	170...264	B	25-PM1-B017
7.5	5.5	7.5	5.5	24.0	170...264	C	25-PM1-B024
10.0	7.5	10.0	7.5	32.2	170...264	D	25-PM1-B032
15.0	11.0	10.0	7.5	48.3	170...264	E	25-PM1-B048
20.0	15.0	15.0	11.0	62.1	170...264	E	25-PM1-B062
380...480V AC (-15%, +10%) – 3-Phase Input, 0...460V 3-Phase Output							
0.5	0.4	0.5	0.4	1.4	323...528	A	25-PM1-D1P4
1.0	0.75	1.0	0.75	2.3	323...528	A	25-PM1-D2P3
2.0	1.5	2.0	1.5	4.0	323...528	A	25-PM1-D4P0
3.0	2.2	3.0	2.2	6.0	323...528	A	25-PM1-D6P0
5.0	4.0	5.0	4.0	10.5	323...528	B	25-PM1-D010
7.5	5.5	7.5	5.5	13.0	323...528	C	25-PM1-D013
10.0	7.5	10.0	7.5	17.0	323...528	C	25-PM1-D017
15.0	11.0	15.0	11.0	24.0	323...528	D	25-PM1-D024
20.0	15.0	15.0	11.0	30.0	323...528	D	25-PM1-D030

Output Ratings					Input Voltage Range	Frame Size	Catalog No.
Normal Duty		Heavy Duty		Output Current (A)			
HP	kW	HP	kW				
380...480V AC (-15%, +10%) – 3-Phase Input with EMC Filter, 0...460V 3-Phase Output							
0.5	0.4	0.5	0.4	1.4	323...528	A	25-PM2-D1P4
1.0	0.75	1.0	0.75	2.3	323...528	A	25-PM2-D2P3
2.0	1.5	2.0	1.5	4.0	323...528	A	25-PM2-D4P0
3.0	2.2	3.0	2.2	6.0	323...528	A	25-PM2-D6P0
5.0	4.0	5.0	4.0	10.5	323...528	B	25-PM2-D010
7.5	5.5	7.5	5.5	13.0	323...528	C	25-PM2-D013
10.0	7.5	10.0	7.5	17.0	323...528	C	25-PM2-D017
15.0	11.0	15.0	11.0	24.0	323...528	D	25-PM2-D024
20.0	15.0	15.0	11.0	30.0	323...528	D	25-PM2-D030
25.0	18.5	20.0	15.0	37.0	323...528	E	25-PM2-D037
30.0	22.0	25.0	18.5	43.0	323...528	E	25-PM2-D043
525...600V AC (-15%, +10%) – 3-Phase Input, 0...575V 3-Phase Output							
0.5	0.4	0.5	0.4	0.9	446...660	A	25-PM1-E0P9
1.0	0.75	1.0	0.75	1.7	446...660	A	25-PM1-E1P7
2.0	1.5	2.0	1.5	3.0	446...660	A	25-PM1-E3P0
3.0	2.2	3.0	2.2	4.2	446...660	A	25-PM1-E4P2
5.0	4.0	5.0	4.0	6.6	446...660	B	25-PM1-E6P6
7.5	5.5	7.5	5.5	9.9	446...660	C	25-PM1-E9P9
10.0	7.5	10.0	7.5	12.0	446...660	C	25-PM1-E012
15.0	11.0	15.0	11.0	19.0	446...660	D	25-PM1-E019
20.0	15.0	15.0	11.0	22.0	446...660	D	25-PM1-E022
25.0	18.5	20.0	15.0	27.0	446...660	E	25-PM1-E027
30.0	22.0	25.0	18.5	32.0	446...660	E	25-PM1-E032

PowerFlex 520-Series Control Module

Item	Description	Frame Size	Catalog No.
PowerFlex 523 Control Module	Replacement control module for use with PowerFlex 520-Series drives. Includes:	A...E	25A-CTM1
PowerFlex 525 Control Module	<ul style="list-style-type: none"> Control Module Control Module Front Cover 		25B-CTM1

Other Parts

Item	Description	Frame Size	Catalog No.
PowerFlex 523 Control Module Front Cover	Replacement cover for the control module I/O terminals, EtherNet/IP and DSI ports.	A...E	25A-CTMFC1
PowerFlex 525 Control Module Front Cover			25B-CTMFC1
PowerFlex 520-Series Power Module Front Cover	Replacement cover for the PowerFlex 520-Series power module.	B	25-PMFC-FB
		C	25-PMFC-FC
		D	25-PMFC-FD
		E	25-PMFC-FE
PowerFlex 520-Series Power Terminal Guard	Replacement finger guard for power terminals.	A	25-PTG1-FA
		B	25-PTG1-FB
		C	25-PTG1-FC
		D	25-PTG1-FD
		E	25-PTG1-FE

Other Parts

Item	Description	Frame Size	Catalog No.
PowerFlex 520-Series Heatsink Fan Kit	Replacement fan for drive power module.	A	25-FAN1-FA
		B	25-FAN1-FB
		C	25-FAN1-FC
		D	25-FAN1-FD
		E	25-FAN1-FE
PowerFlex 520-Series EMC Cores	Replacement EMC cores	A	25-CORE-A
			25-CORE-RF-A
		B	25-CORE-B
			25-CORE-RF-B
		C	25-CORE-C
			25-CORE-RF-C
		D	25-CORE-D
			25-CORE-RF-D
		E	25-CORE-E
			25-CORE-RF-E

Communication Option Kits and Accessories

Item	Description	Catalog No.
Communication Adapters	Embedded communication options for use with the PowerFlex 520-Series drives: <ul style="list-style-type: none"> • DeviceNet™ • Dual Port EtherNet/IP™ • PROFIBUS™ DP-V1 	25-COMM-D 25-COMM-E2P 25-COMM-P
Compact I/O Module	Three channel	1769-SM2
Universal Serial Bus™ (USB) Converter Module	Provides serial communication with DF1 protocol for use with Connected Components Workbench software. Includes: <ul style="list-style-type: none"> • 2 m USB cable (1) • 20-HIM-H10 cable (1) • 22-HIM-H10 cable (1) 	1203-USB
Serial Converter Module (RS485 to RS232)	Provides serial communication with DF1 protocol for use with Connected Components Workbench software. Includes: <ul style="list-style-type: none"> • DSI to RS232 serial converter (1) • 1203-SFC serial cable (1) • 22-RJ45CBL-C20 cable (1) 	22-SCM-232
DSI Cable	2.0 m RJ45 to RJ45 cable, male to male connectors.	22-RJ45CBL-C20
Serial Cable	2.0 m serial cable with a locking low profile connector to connect to the serial converter and a 9-pin sub-miniature D female connector to connect to a computer.	1203-SFC
Splitter Cable	RJ45 one to two port splitter cable (Modbus only)	AK-U0-RJ45-SC1
Terminating Resistors	RJ45 120 Ohm resistors (2 pieces)	AK-U0-RJ45-TR1
Terminal Block	RJ45 Two position terminal block (5 pieces)	AK-U0-RJ45-TB2P
Connected Components Workbench Software (Download or DVD-ROM)	Windows-based software packages for programming and configuring Allen-Bradley drives and other Rockwell Automation products. Compatibility: Windows XP, Windows Vista and Windows 7	http://ab.rockwellautomation.com/programmable-controllers/connected-components-workbench-software

Bulletin 1321-3R Series Line Reactors

Output Ratings ⁽¹⁾				Input Line Reactor ⁽³⁾⁽⁴⁾		Output Line Reactor ⁽³⁾⁽⁴⁾	
Normal Duty		Heavy Duty		IP00 (Open Style)	IP11 (NEMA/UL Type 1)	IP00 (Open Style)	IP11 (NEMA/UL Type 1)
HP	kW	HP	kW	Catalog No.	Catalog No.	Catalog No.	Catalog No.
200...240V 50/60 Hz 1-Phase⁽²⁾							
0.25	0.2	0.25	0.2	1321-3R4-A	1321-3RA4-A	1321-3R2-D	1321-3RA2-D
0.5	0.4	0.5	0.4	1321-3R8-A	1321-3RA8-A	1321-3R2-D	1321-3RA2-D
1.0	0.75	1.0	0.75	1321-3R8-A	1321-3RA8-A	1321-3R4-A	1321-3RA4-A
2.0	1.5	2.0	1.5	1321-3R18-A	1321-3RA18-A	1321-3R8-A	1321-3RA8-A
3.0	2.2	3.0	2.2	1321-3R18-A	1321-3RA18-A	1321-3R12-A	1321-3RA12-A
200...240V 50/60 Hz 3-Phase							
0.25	0.2	0.25	0.2	1321-3R2-D	1321-3RA2-D	1321-3R2-D	1321-3RA2-D
0.5	0.4	0.5	0.4	1321-3R2-D	1321-3RA2-D	1321-3R2-D	1321-3RA2-D
1.0	0.75	1.0	0.75	1321-3R4-A	1321-3RA4-A	1321-3R4-A	1321-3RA4-A
2.0	1.5	2.0	1.5	1321-3R8-A	1321-3RA8-A	1321-3R8-A	1321-3RA8-A
3.0	2.2	3.0	2.2	1321-3R12-A	1321-3RA12-A	1321-3R12-A	1321-3RA12-A
5.0	4.0	5.0	4.0	1321-3R18-A	1321-3RA18-A	1321-3R18-A	1321-3RA18-A
7.5	5.5	7.5	5.5	1321-3R25-A	1321-3RA25-A	1321-3R25-A	1321-3RA25-A
10.0	7.5	10.0	7.5	1321-3R35-A	1321-3RA35-A	1321-3R35-A	1321-3RA35-A
15.0	11.0	10.0	7.5	1321-3R45-A	1321-3RA45-A	1321-3R45-A	1321-3RA45-A
20.0	15.0	15.0	11.0	1321-3R55-A (ND) 1321-3R45-A (HD)	1321-3RA55-A (ND) 1321-3RA45-A (HD)	1321-3R55-A (ND) 1321-3R45-A (HD)	1321-3RA55-A (ND) 1321-3RA45-A (HD)
380...480V 50/60 Hz 3-Phase							
0.5	0.4	0.5	0.4	1321-3R2-B	1321-3RA2-B	1321-3R2-B	1321-3RA2-B
1.0	0.75	1.0	0.75	1321-3R4-C	1321-3RA4-C	1321-3R4-C	1321-3RA4-C
2.0	1.5	2.0	1.5	1321-3R4-B	1321-3RA4-B	1321-3R4-B	1321-3RA4-B
3.0	2.2	3.0	2.2	1321-3R8-C	1321-3RA8-C	1321-3R8-C	1321-3RA8-C
5.0	4.0	5.0	4.0	1321-3R12-B	1321-3RA12-B	1321-3R12-B	1321-3RA12-B
7.5	5.5	7.5	5.5	1321-3R12-B	1321-3RA12-B	1321-3R12-B	1321-3RA12-B
10.0	7.5	10.0	7.5	1321-3R18-B	1321-3RA18-B	1321-3R18-B	1321-3RA18-B
15.0	11.0	15.0	11.0	1321-3R25-B	1321-3RA25-B	1321-3R25-B	1321-3RA25-B
20.0	15.0	15.0	11.0	1321-3R35-B (ND) 1321-3R25-B (HD)	1321-3RA35-B (ND) 1321-3RA25-B (HD)	1321-3R35-B (ND) 1321-3R25-B (HD)	1321-3RA35-B (ND) 1321-3RA25-B (HD)
25.0	18.5	20.0	15.0	1321-3R35-B	1321-3RA35-B	1321-3R35-B	1321-3RA35-B
30.0	22.0	25.0	18.5	1321-3R45-B (ND) 1321-3R35-B (HD)	1321-3RA45-B (ND) 1321-3RA35-B (HD)	1321-3R45-B (ND) 1321-3R35-B (HD)	1321-3RA45-B (ND) 1321-3RA35-B (HD)
525...600V 50/60 Hz 3-Phase							
0.5	0.4	0.5	0.4	1321-3R1-C	1321-3RA1-C	1321-3R1-C	1321-3RA1-C
1.0	0.75	1.0	0.75	1321-3R2-B	1321-3RA2-B	1321-3R2-B	1321-3RA2-B
2.0	1.5	2.0	1.5	1321-3R4-C	1321-3RA4-C	1321-3R4-C	1321-3RA4-C
3.0	2.2	3.0	2.2	1321-3R4-B	1321-3RA4-B	1321-3R4-B	1321-3RA4-B
5.0	4.0	5.0	4.0	1321-3R8-C	1321-3RA8-C	1321-3R8-C	1321-3RA8-C
7.5	5.5	7.5	5.5	1321-3R12-B	1321-3RA12-B	1321-3R12-B	1321-3RA12-B
10.0	7.5	10.0	7.5	1321-3R12-B	1321-3RA12-B	1321-3R12-B	1321-3RA12-B
15.0	11.0	15.0	11.0	1321-3R18-B	1321-3RA18-B	1321-3R18-B	1321-3RA18-B
20.0	15.0	15.0	11.0	1321-3R25-B (ND) 1321-3R18-B (HD)	1321-3RA25-B (ND) 1321-3RA18-B (HD)	1321-3R25-B (ND) 1321-3R18-B (HD)	1321-3RA25-B (ND) 1321-3RA18-B (HD)
25.0	18.5	20.0	15.0	1321-3R35-C (ND) 1321-3R25-C (HD)	1321-3RA35-C (ND) 1321-3RA25-C (HD)	1321-3R35-C (ND) 1321-3R25-C (HD)	1321-3RA35-C (ND) 1321-3RA25-C (HD)
30.0	22.0	25.0	18.5	1321-3R35-C (ND) 1321-3R25-B (HD)	1321-3RA35-C (ND) 1321-3RA25-B (HD)	1321-3R35-C (ND) 1321-3R25-B (HD)	1321-3RA35-C (ND) 1321-3RA25-B (HD)

- (1) Normal Duty and Heavy Duty ratings for 15 HP (11 kW) and below are identical except for 200...240V 3-Phase 15 HP (11 kW) drive.
- (2) Standard 3-phase reactors can be used for 1-phase applications by routing each of the two supply conductors through an outside coil and leaving the center open.
- (3) Catalog numbers listed are for 3% impedance at 60 Hz. 5% impedance reactor types are also available. See publication [1321-TD001](#).
- (4) Input line reactors were sized based on the NEC fundamental motor amps. Output line reactors were sized based on the VFD rated output currents.

Product Dimensions

The PowerFlex 520-series drive is available in five frame sizes. See the [PowerFlex 520-Series Drive Ratings on page 163](#) for information on power ratings.

PowerFlex 520-Series Drive Weight

Frame Size	Weight (kg/lb)
A	1.1 / 2.4
B	1.6 / 3.5
C	2.3 / 5.0
D	3.9 / 8.6
E	12.9 / 28.4

IP 20/Open Type – Frame A

Dimensions are in millimeters and (inches)

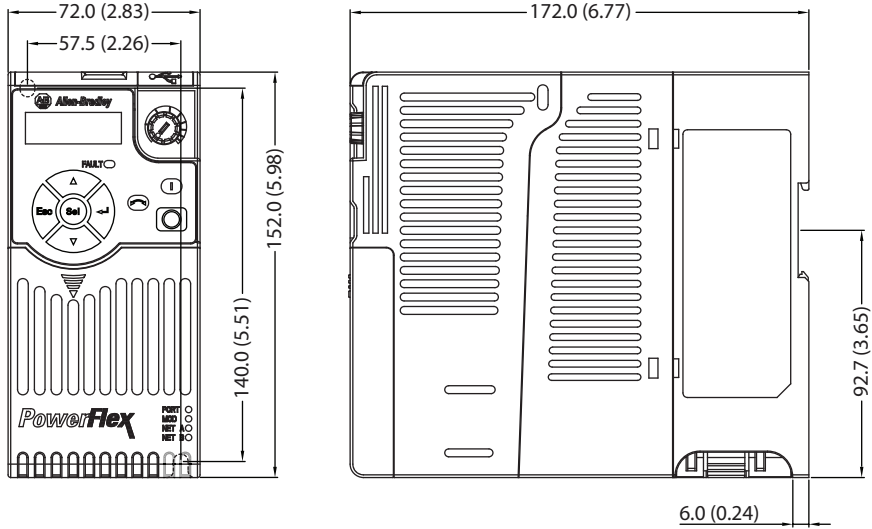

IP 20/Open Type – Frame B

Dimensions are in millimeters and (inches)

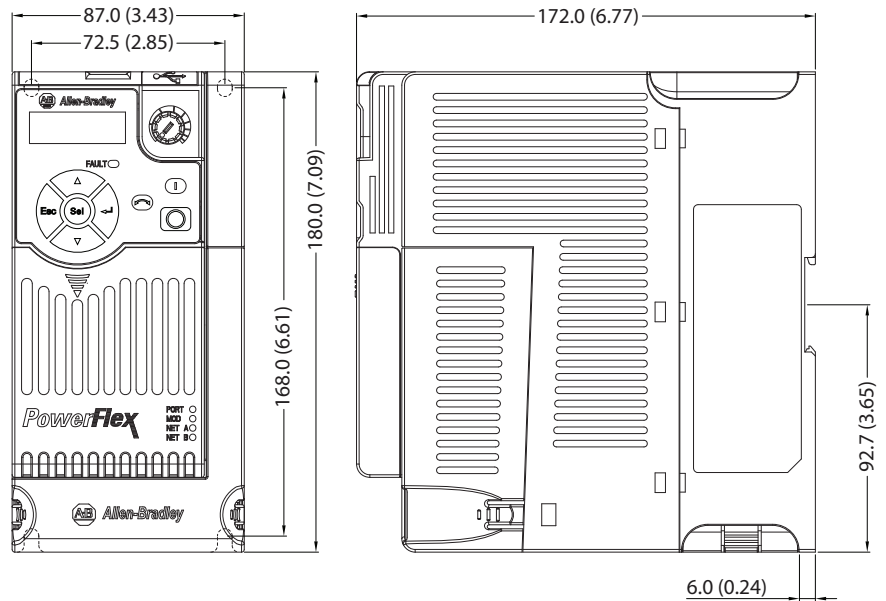

IP 20/Open Type – Frame C

Dimensions are in millimeters and (inches)

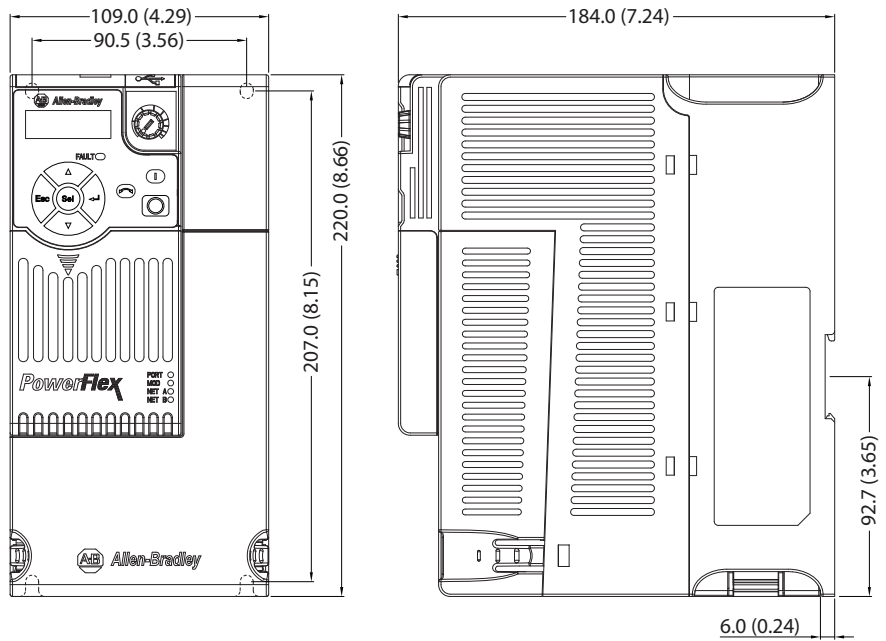

IP 20/Open Type – Frame D

Dimensions are in millimeters and (inches)

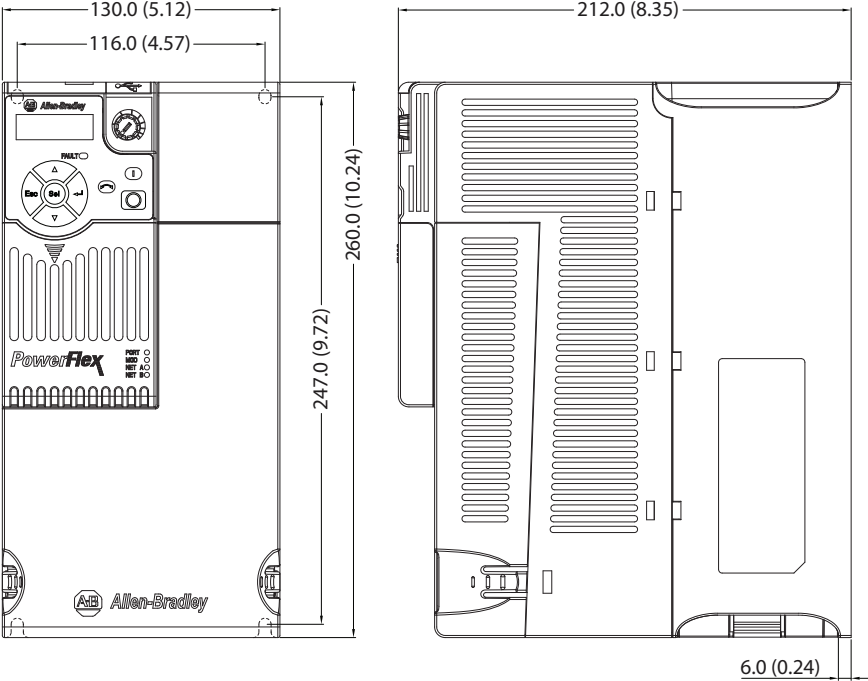

IP 20/Open Type – Frame E

Dimensions are in millimeters and (inches)

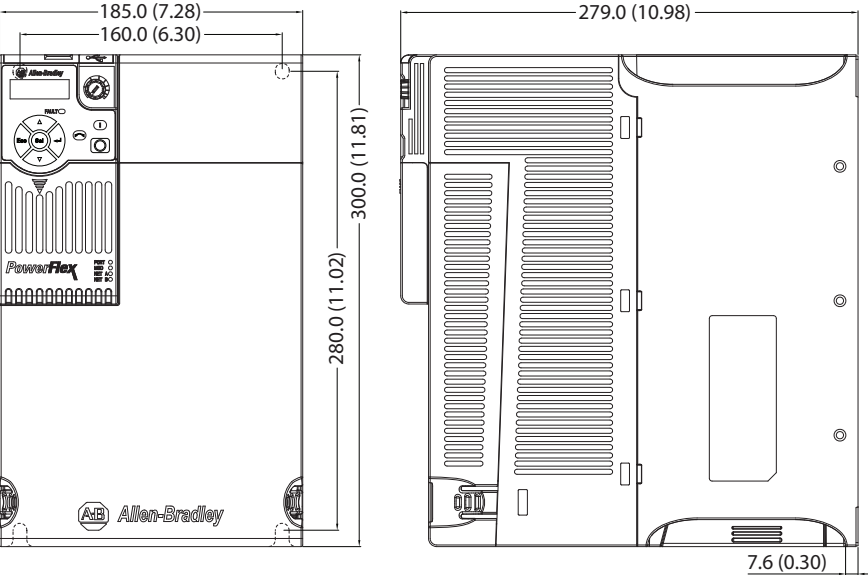

Control Module Fan Kit

25-FAN1-70C

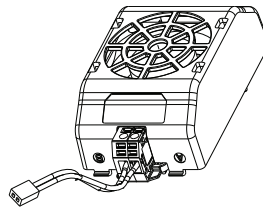

25-FAN2-70C

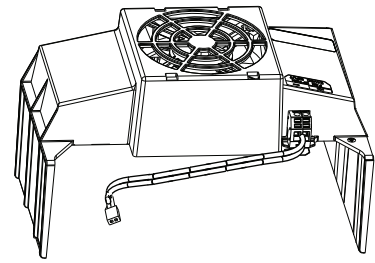

Specifications	25-FAN1-70C	25-FAN2-70C
Rated Voltage	24V DC	
Operation Voltage	14...27.6V DC	
Input Current	0.1 A	0.15 A
Speed (Reference)	7000 rpm	4500 ± 10% rpm
Maximum Air Flow (At zero static pressure)	0.575 m ³ /min	1.574 m ³ /min
Maximum Air Pressure (At zero air flow)	7.70 mmH ₂ O	9.598 mmH ₂ O
Acoustical Noise	40.5 dB-A	46.0 dB-A
Insulation Type	UL Class A	
Frame Size	Frame A...D	Frame E
Wire Size	0.32 mm ² (22 AWG)	
Torque	0.29...0.39 Nm (2.6...3.47 lb-in.)	

IP 20/Open Type with Control Module Fan Kit – Frame A...C

Dimensions are in millimeters and (inches)

Frame A

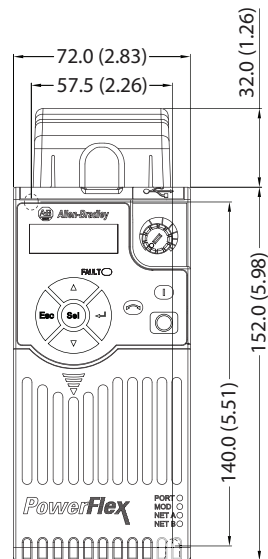

Frame B

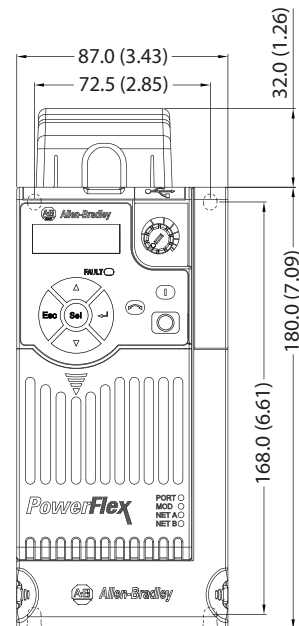

Frame C

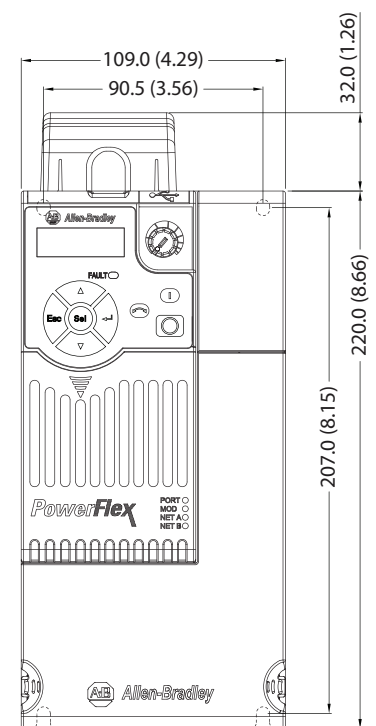

IMPORTANT An external 24V DC power source is required when using the Control Module Fan Kit with drive frames A, B, and C.

IP 20/Open Type with Control Module Fan Kit – Frame D...E

Dimensions are in millimeters and (inches)

Frame D

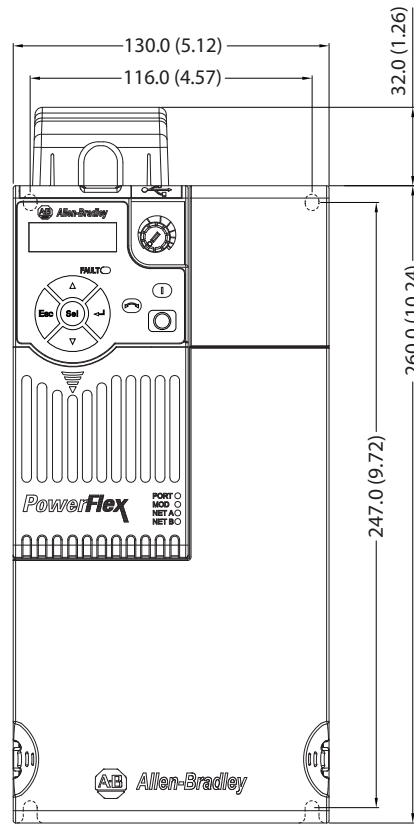

Frame E

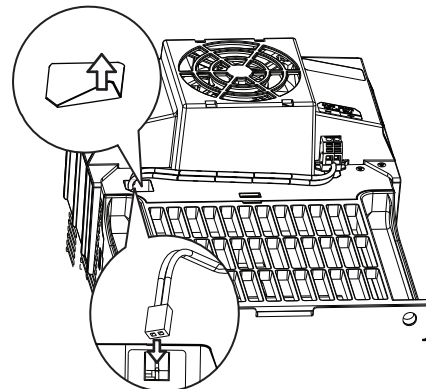
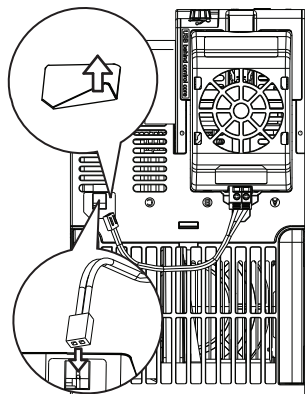
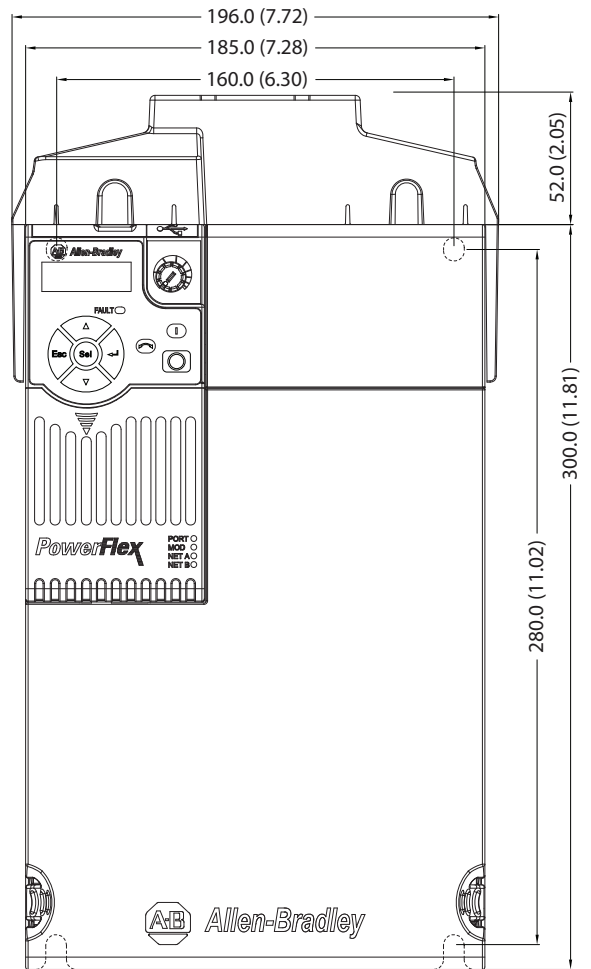

IMPORTANT Remove the label to access the built-in 24V supply on drive frames D and E for use with the Control Module Fan Kit.

IP 30/NEMA 1/UL Type 1 – Frame A

Dimensions are in millimeters and (inches)

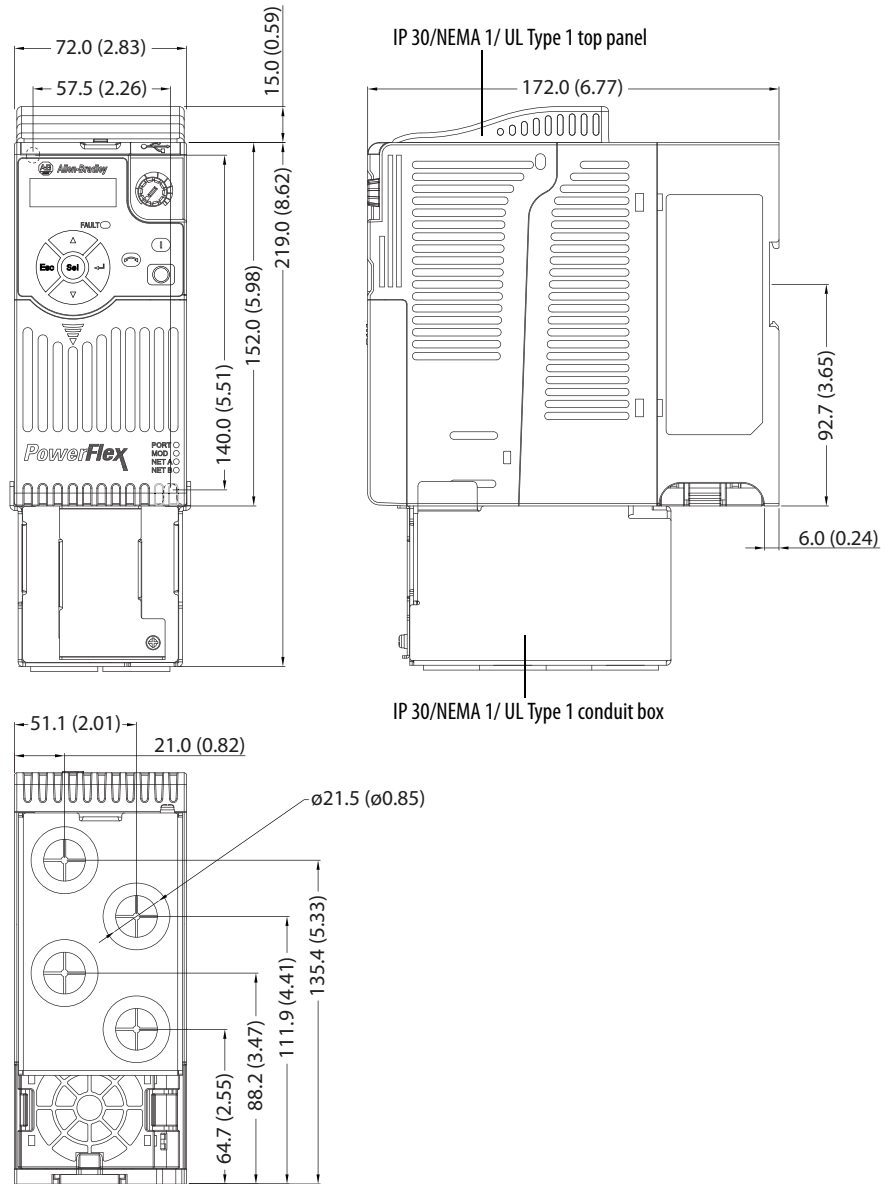

IP 30/NEMA 1/UL Type 1 – Frame B

Dimensions are in millimeters and (inches)

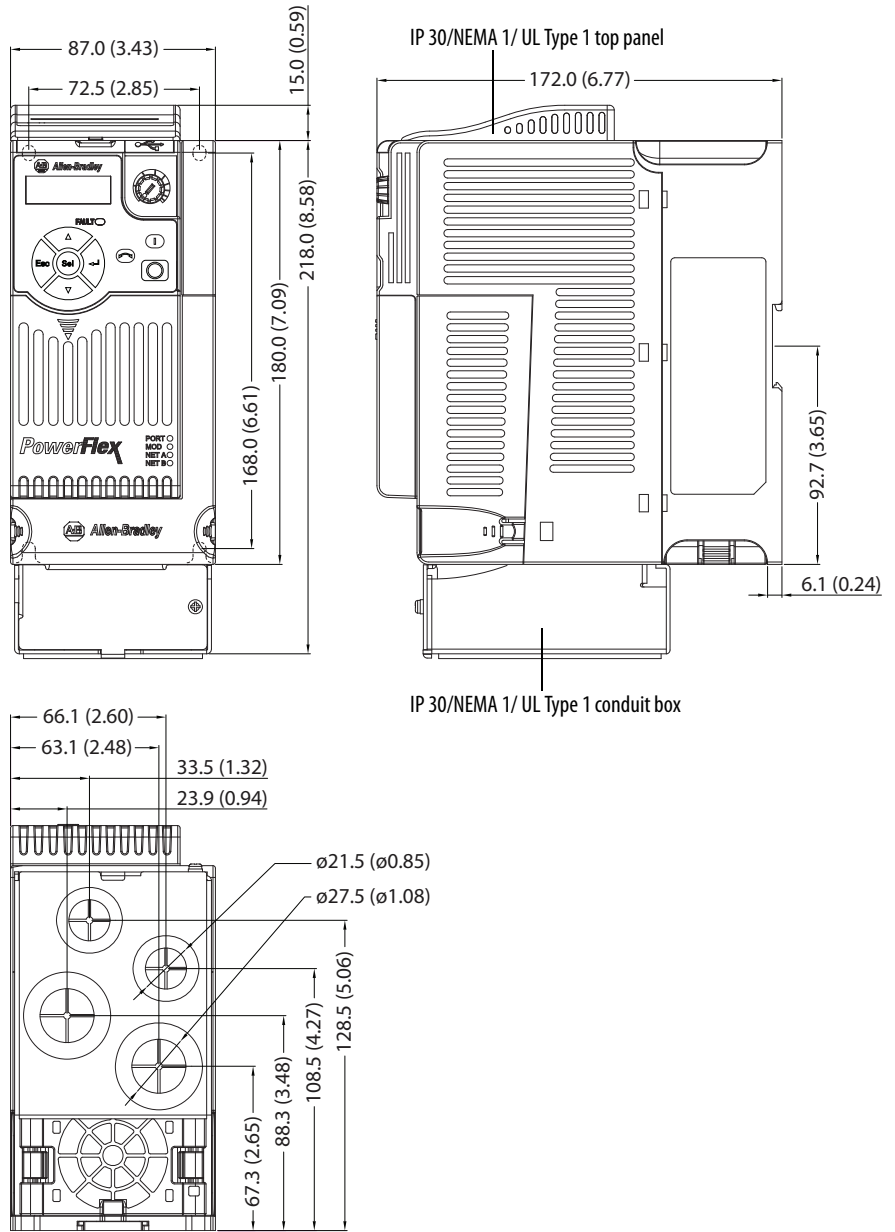

IP 30/NEMA 1/UL Type 1 – Frame C

Dimensions are in millimeters and (inches)

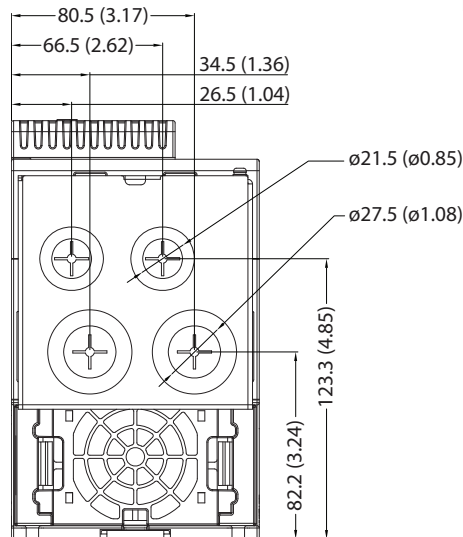
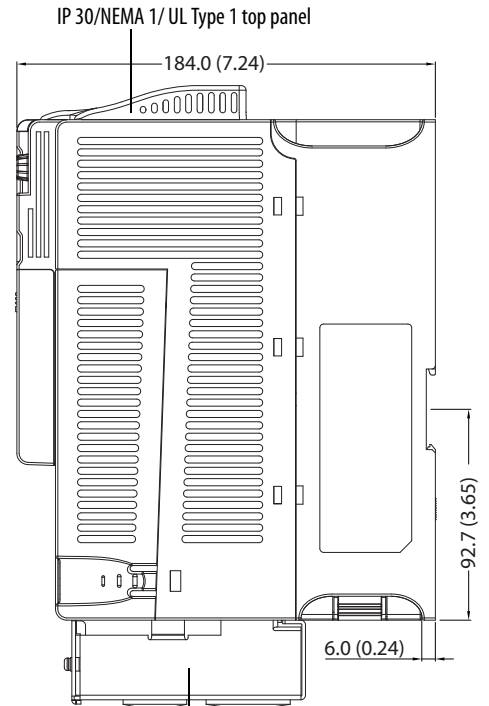
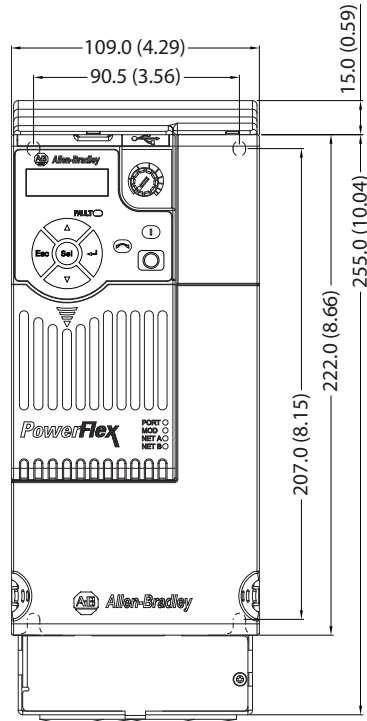

IP 30/NEMA 1/UL Type 1 – Frame D

Dimensions are in millimeters and (inches)

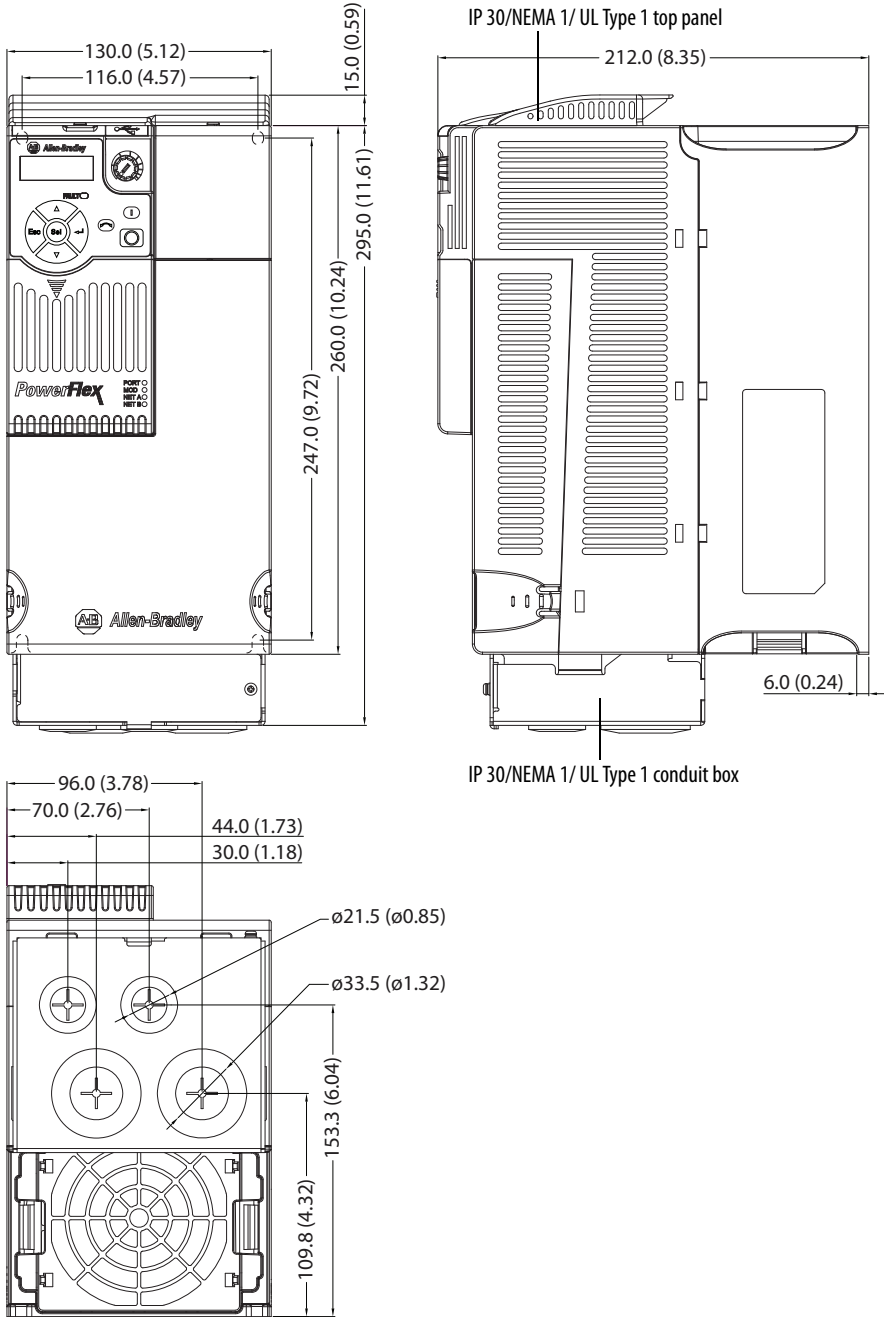

IP 30/NEMA 1/UL Type 1 – Frame E

Dimensions are in millimeters and (inches)

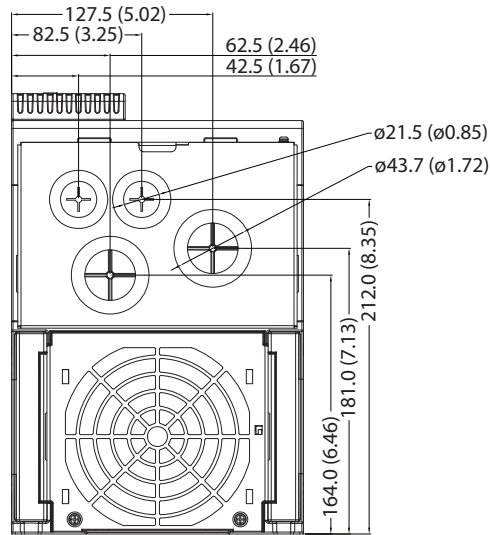
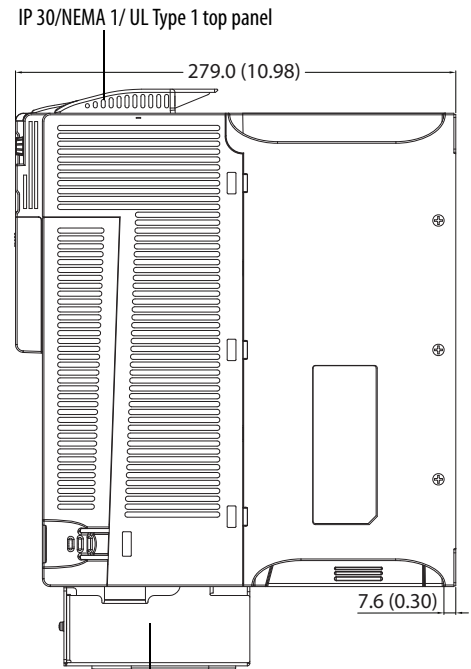
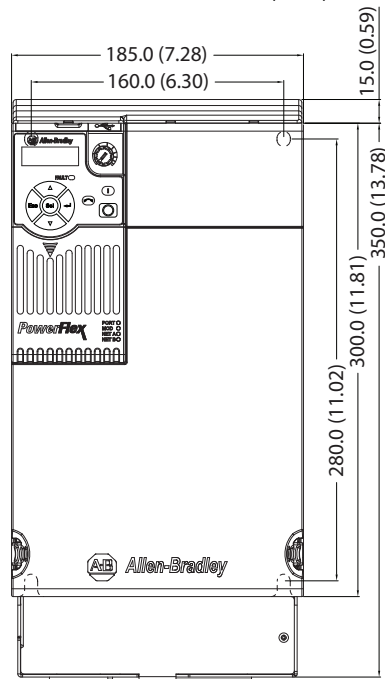

EMC Line Filter – Frame A

Dimensions are in millimeters and (inches)

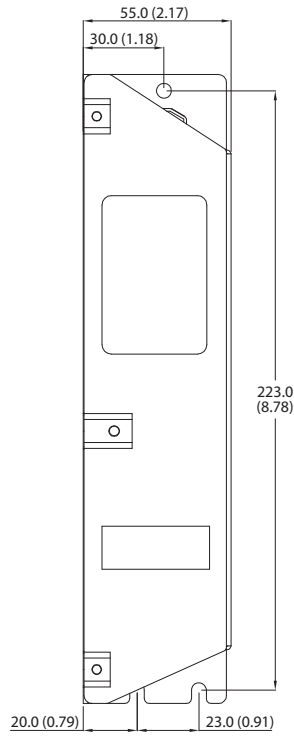

Filter can be mounted onto the back of the drive.

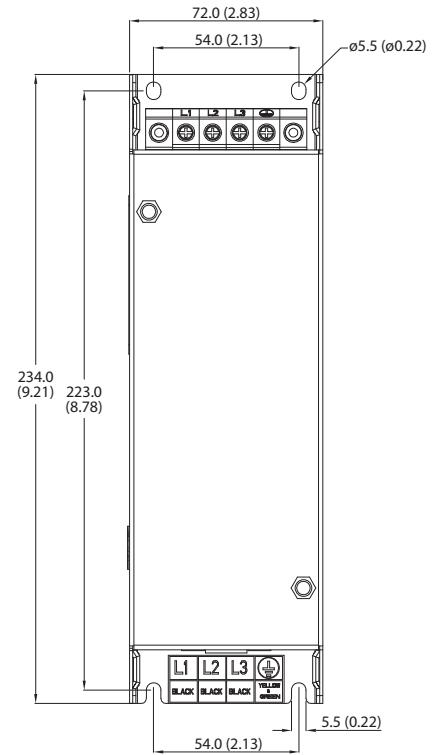

EMC Line Filter – Frame B

Dimensions are in millimeters and (inches)

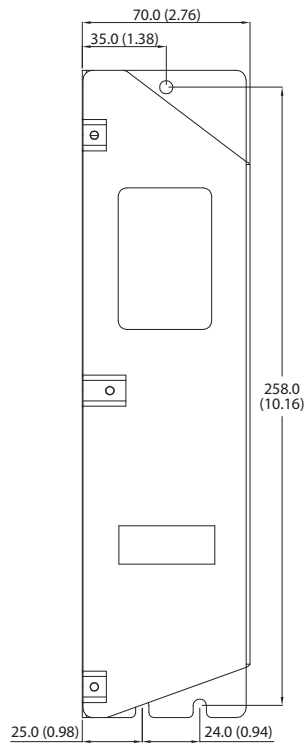

Filter can be mounted onto the back of the drive.

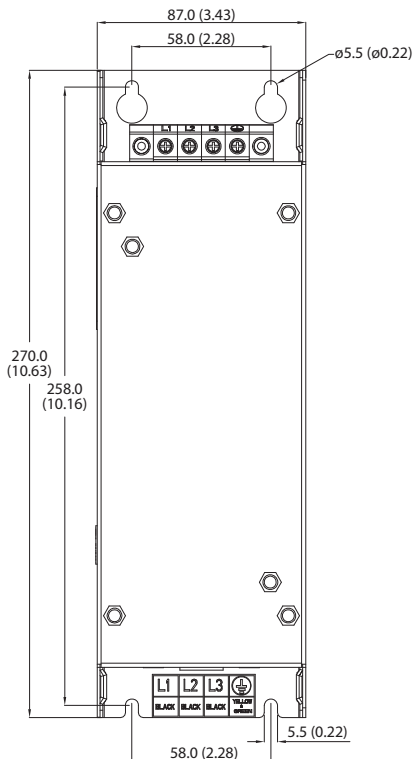

EMC Line Filter – Frame C

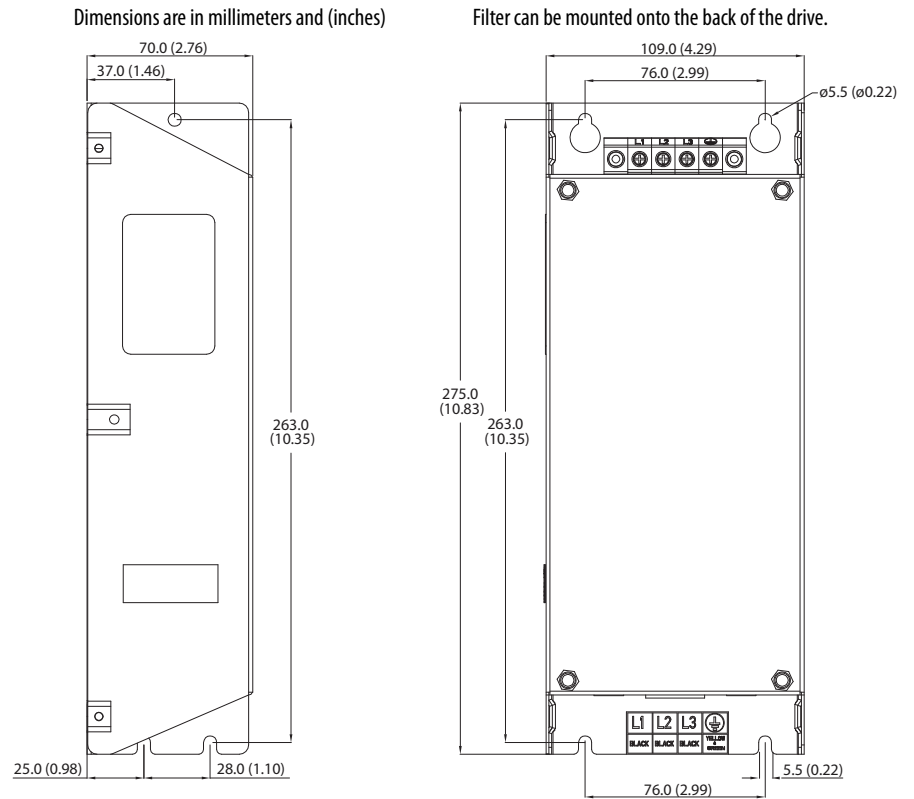

EMC Line Filter – Frame D

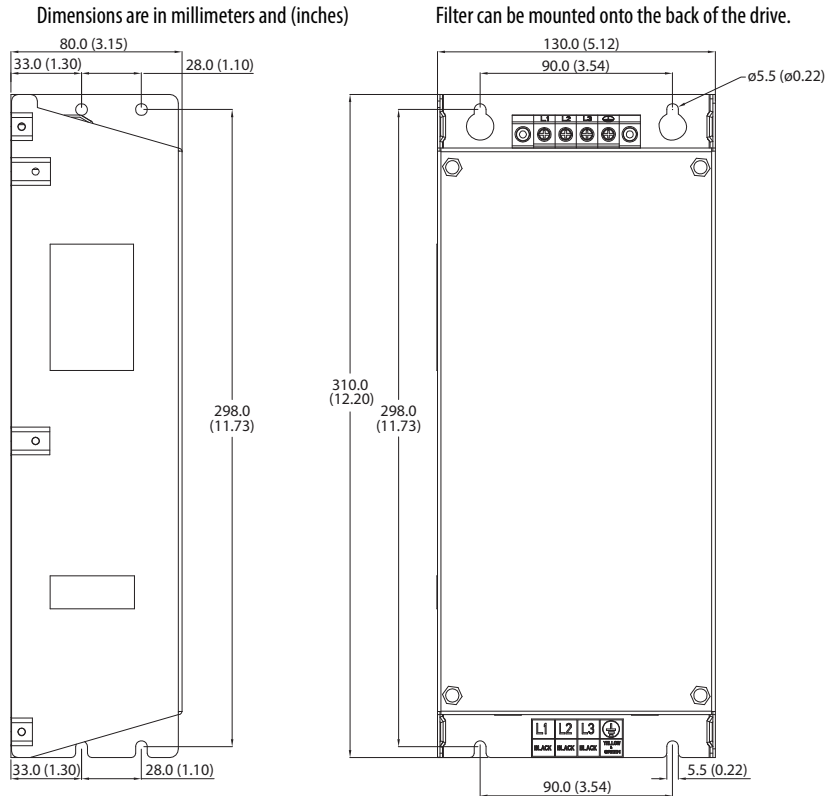

EMC Line Filter – Frame E

Dimensions are in millimeters and (inches)

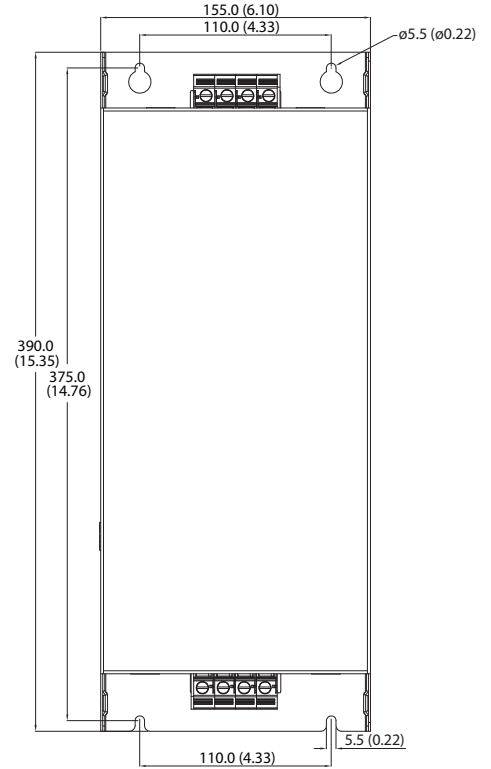
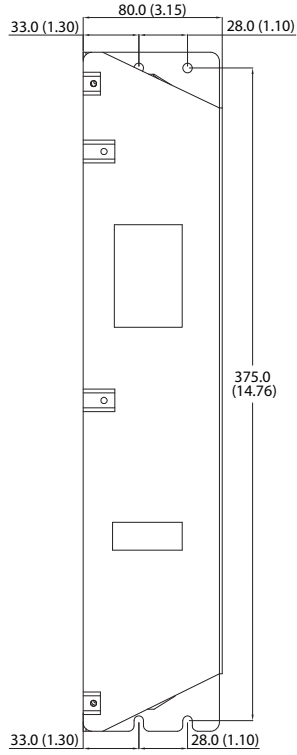

Optional Accessories and Kits Installing a Communication Adapter

1. Insert the communication adapter interface connector into the Control Module. Make sure the indicator line on the connector is aligned with the surface of the Control Module.

For PowerFlex 523

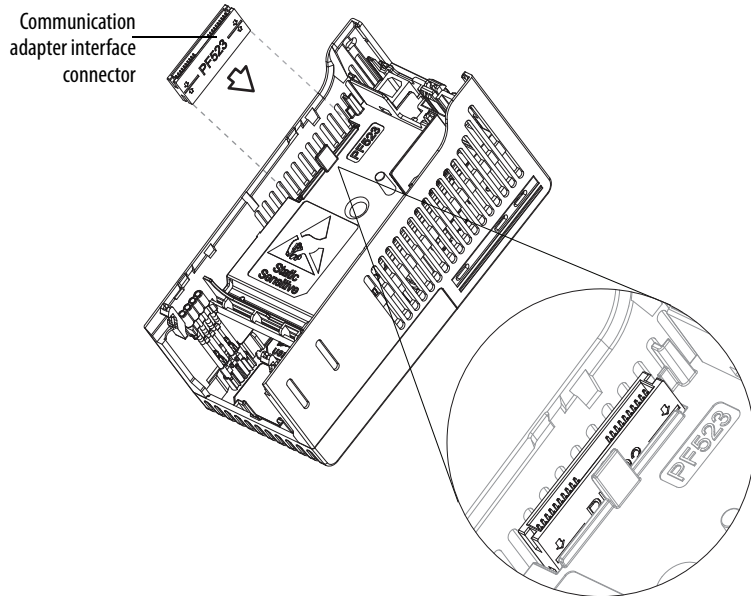

For PowerFlex 525

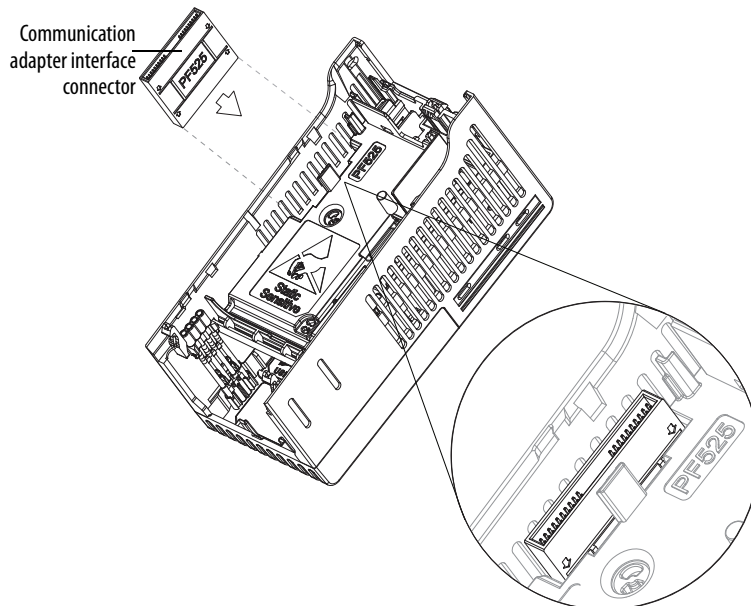

2. Align the connectors on the communication adapter to the communication adapter interface connector, then push the back cover down.

3. Press along the edges of the back cover until it snaps firmly into place.

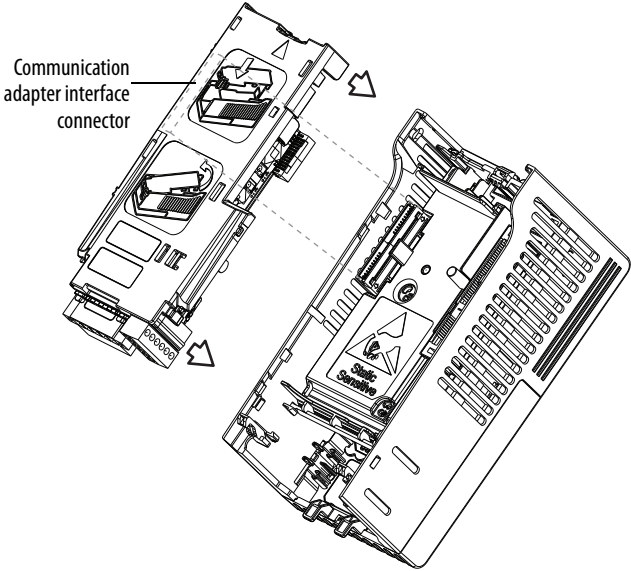

Removing a Communication Adapter

1. Insert a finger into the slot at the top of the back cover. Lift to separate the back cover from the Control Module.

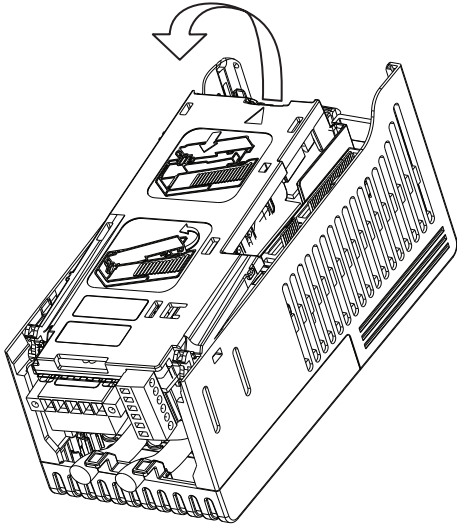

Notes:

RS485 (DSI) Protocol

PowerFlex 520-series drives support the RS485 (DSI) protocol to allow efficient operation with Rockwell Automation peripherals. In addition, some Modbus functions are supported to allow simple networking. PowerFlex 520-series drives can be multi-dropped on an RS485 network using Modbus protocol in RTU mode.

PowerFlex 520-Series Drive Network

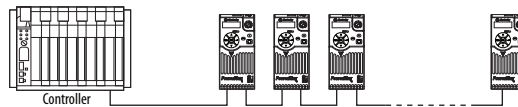

For information regarding EtherNet/IP or other communication protocols, refer to the appropriate user manual.

Network Wiring

Network wiring consists of a shielded 2-conductor cable that is daisy-chained from node to node.



ATTENTION: Never attempt to connect a Power over Ethernet (PoE) cable to the RS485 port. Doing so may damage the circuitry.

Network Wiring Diagram Example

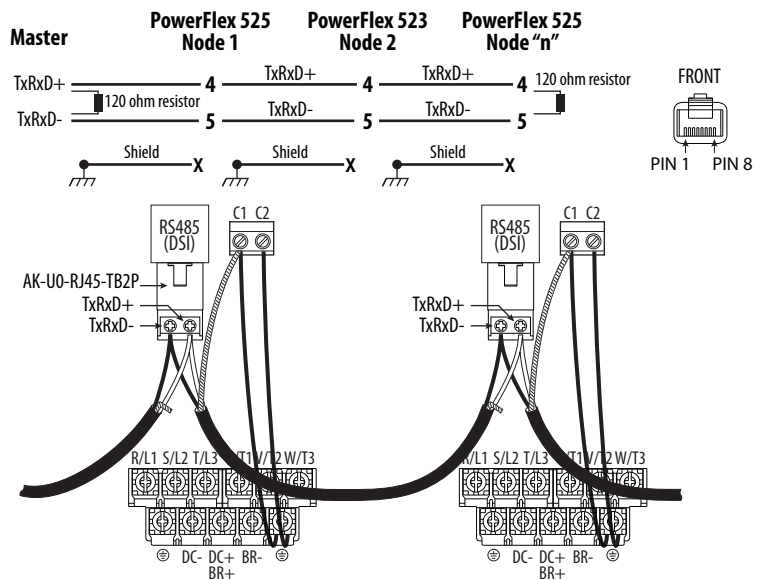

IMPORTANT The shield is connected at **ONLY ONE** end of each cable segment.

Only pins 4 and 5 on the RJ45 plug should be wired. The other pins on the PowerFlex 520-series drive’s RJ45 socket must not be connected because they contain power, etc. for other Rockwell Automation peripheral devices.

Wiring terminations on the master controller will vary depending on the master controller used and “TxRxD+” and “TxRxD-” are shown for illustration purposes only. Refer to the master controller’s user manual for network terminations. Note that there is no standard for the “+” and “-” wires, and consequently Modbus device manufacturers interpret them differently. If you have problems with initially establishing communications, try swapping the two network wires at the master controller.

Standard RS485 wiring practices apply.

- Termination resistors need to be applied at each end of the network cable.
- RS485 repeaters may need to be used for long cable runs, or if greater than 32 nodes are needed on the network.
- Network wiring should be separated from power wires by at least 0.3 meters (1 foot).
- Network wiring should only cross power wires at a right angle.

I/O Terminal C1 (RJ45 Shield) for the Ethernet and DSI network cables on the PowerFlex 520-series drive must also be connected to PE ground (there are two PE terminals on the drive). The shield for the network cables should be connected to PE ground at one end only.

I/O Terminal C2 (Comm Common) is internally tied to Network Common for the network signals, and NOT to RJ45 Shield. Tying I/O Terminal C2 to PE ground may improve noise immunity in some applications.

See I/O Control Terminal Designations on [page 38](#) and [page 40](#) for more information.

Parameter Configuration

The following PowerFlex 520-series drive parameters are used to configure the drive to operate on a DSI network.

Configuring Parameters for DSI Network

Parameter	Details	Reference
P046 [Start Source 1]	Set to 3 “Serial/DSI” if Start is controlled from the network.	page 80
P047 [Speed Reference1]	Set to 3 “Serial/DSI” if the Speed Reference is controlled from the network.	page 80
C123 [RS485 Data Rate]	Sets the data rate for the RS485 (DSI) Port. All nodes on the network must be set to the same data rate.	page 94
C124 [RS485 Node Addr]	Sets the node address for the drive on the network. Each device on the network requires a unique node address.	page 94
C125 [Comm Loss Action]	Selects the drive’s response to communication problems.	page 94
C126 [Comm Loss Time]	Sets the time that the drive will remain in communication loss before the drive implements C125 [Comm Loss Action].	page 94
C127 [Comm Format]	Sets the transmission mode, data bits, parity and stop bits for the RS485 (DSI) Port. All nodes on the network must be set to the same setting.	page 95
C121 [Comm Write Mode]	Set to 0 “Save” when programming drive. Set to 1 “RAM only” to only write to volatile memory.	page 94

Supported Modbus Function Codes

The peripheral interface (DSI) used on PowerFlex 520-series drives supports some of the Modbus function codes.

Supported Modbus Function Codes

Modbus Function Code (Decimal)	Command
03	Read Holding Registers
06	Preset (Write) Single Register
16 (10 Hexadecimal)	Preset (Write) Multiple Registers

IMPORTANT Modbus devices can be 0-based (registers are numbered starting at 0) or 1-based (registers are numbered starting at 1). Depending on the Modbus Master used, the register addresses listed on the following pages may need to be offset by +1. For example, Logic Command may be register address 8192 for some master devices (e.g. ProSoft 3150-MCM SLC Modbus scanner) and 8193 for others (e.g. PanelViews).

Writing (06) Logic Command Data

The PowerFlex 520-series drive can be controlled through the network by sending Function Code 06 writes to register address 2000H (Logic Command). [P046](#) [Start Source 1] must be set to 3 “Serial/DSI” in order to accept the commands. PowerFlex 523 drives support only Velocity bit definitions. PowerFlex 525 drives can use Parameter [C122](#) [Cmd Stat Select] to select either Velocity or Position bit definitions.

TIP Powerup/Reset the drive after selecting an option for C122 [Cmd Stat Select] for the change to take effect.

Velocity Bit Definitions

Comm Logic Command – C122 = 0 “Velocity”			
Address (Decimal)	Bit(s)	Description	
2000H (8192)	0	1 = Stop, 0 = Not Stop	
	1	1 = Start, 0 = Not Start	
	2	1 = Jog, 0 = No Jog	
	3	1 = Clear Faults, 0 = Not Clear Faults	
	5, 4	00	No Command
		01	Forward Command
		10	Reverse Command
		11	No Command
	6	1 = Force Keypad Control, 0 = Not Force Keypad Control	
	7	1 = MOP Increment, 0 = Not Increment	
	9, 8	00	No Command
		01	Accel Rate 1 Enable
		10	Accel Rate 2 Enable
		11	Hold Accel Rate Selected
	11, 10	00	No Command
01		Decel Rate 1 Enable	
10		Decel Rate 2 Enable	
11		Hold Decel Rate Selected	
14, 13, 12	000	No Command	
	001	Freq. Source = P047 [Speed Reference1]	
	010	Freq. Source = P049 [Speed Reference2]	
	011	Freq. Source = P051 [Speed Reference3]	
	100	A410 [Preset Freq 0]	
	101	A411 [Preset Freq 1]	
	110	A412 [Preset Freq 2]	
111	A413 [Preset Freq 3]		
15	1 = MOP Decrement, 0 = Not Decrement		

Position Bit Definitions

Comm Logic Command – C122 = 1 “Position”			
Address (Decimal)	Bit(s)	Description	
2000H (8192)	0	1 = Stop, 0 = Not Stop	
	1	1 = Start, 0 = Not Start	
	2	1 = Jog, 0 = No Jog	
	3	1 = Clear Faults, 0 = Not Clear Faults	
	5, 4	00	No Command
		01	Forward Command
		10	Reverse Command
		11	No Command
	6	1 = Logic In 1	
	7	1 = Logic In 2	
	10, 9, 8	000	Freq. and Position Step 0
		001	Freq. and Position Step 1
		010	Freq. and Position Step 2
		011	Freq. and Position Step 3
		100	Freq. and Position Step 4
		101	Freq. and Position Step 5
110		Freq. and Position Step 6	
111		Freq. and Position Step 7	
11	1 = Find Home		
12	1 = Hold Step		
13	1 = Pos Redefine		
14	1 = Sync Enable		
15	1 = Traverse Disable		

Writing (06) Comm Frequency Command

The PowerFlex 520-series drive Comm Frequency Command can be controlled through the network by sending Function Code 06 writes to register address 2001H (Comm Frequency Command).

Comm Frequency Command

Reference	
Address (Decimal)	Description
2001H (8193)	Used by internal comm modules to control the reference of the drive. In units of 0.01 Hz.

Reading (03) Logic Status Data

The PowerFlex 520-series drive Logic Status data can be read through the network by sending Function Code 03 reads to register address 2100H (Logic Status). PowerFlex 523 drives support only Velocity bit definitions. PowerFlex 525 drives can use Parameter [C122](#) [Cmd Stat Select] to select either Velocity or Position bit definitions.

Velocity Bit Definitions

Comm Logic Status – C122 = 0 “Velocity”		
Address (Decimal)	Bit(s)	Description
2100H (8448)	0	1 = Ready, 0 = Not Ready
	1	1 = Active (Running), 0 = Not Active
	2	1 = Cmd Forward, 0 = Cmd Reverse
	3	1 = Rotating Forward, 0 = Rotating Reverse
	4	1 = Accelerating, 0 = Not Accelerating
	5	1 = Decelerating, 0 = Not Decelerating
	6	Not Used
	7	1 = Faulted, 0 = Not Faulted
	8	1 = At Reference, 0 = Not At Reference
	9	1 = Main Freq Controlled by Active Comm
	10	1 = Operation Cmd Controlled by Active Comm
	11	1 = Parameters have been locked
	12	Digital Input 1 Status
	13	Digital Input 2 Status
	14	Digital Input 3 Status
15	Digital Input 4 Status	

Position Bit Definitions

Comm Logic Status – C122 = 1 “Position”		
Address (Decimal)	Bit(s)	Description
2100H (8448)	0	1 = Ready, 0 = Not Ready
	1	1 = Active (Running), 0 = Not Active
	2	1 = Cmd Forward, 0 = Cmd Reverse
	3	1 = Rotating Forward, 0 = Rotating Reverse
	4	1 = Accelerating, 0 = Not Accelerating
	5	1 = Decelerating, 0 = Not Decelerating
	6	1 = Forward Travel Position, 0 = Reverse Travel Position
	7	1 = Faulted, 0 = Not Faulted
	8	1 = At Reference, 0 = Not At Reference
	9	1 = At Position, 0 = Not At Position
	10	1 = At Home, 0 = Not At Home
	11	1 = Drive Homed, 0 = Not Drive Homed
	12	1 = Sync Hold, 0 = Not Sync Hold
	13	1 = Sync Ramp, 0 = Not Sync Ramp
	14	1 = Traverse On, 0 = Traverse Off
15	1 = Traverse Decel, 0 = Not Traverse Decel	

Reading (03) Drive Error Codes

The PowerFlex 520-series Error Code data can be read through the network by sending Function Code 03 reads to register address 2101H (Drive Error Codes).

Drive Error Codes

Logic Status		
Address (Decimal)	Value (Decimal)	Description
2101H (8449)	0	No Fault
	2	Auxiliary Input
	3	Power Loss
	4	Undervoltage
	5	Overvoltage
	6	Motor Stalled
	7	Motor Overload
	8	Heatsink Overtemperature
	9	Control Module Overtemperature
	12	HW Overcurrent (300%)
	13	Ground Fault
	15	Load Loss
	21	Output Phase Loss
	29	Analog Input Loss
	33	Auto Restart Tries
	38	Phase U to Ground Short
	39	Phase V to Ground Short
	40	Phase W to Ground Short
	41	Phase UV Short
	42	Phase UW Short
	43	Phase VW Short
	48	Parameters Defaulted
	59	Safety Open
	63	Software Overcurrent
	64	Drive Overload
	70	Power Unit Fail
	71	DSI Network Loss
	72	Option Card Network Loss
	73	Embedded EtherNet/IP Adapter Network Loss
	80	AutoTune Fail
	81	DSI Communication Loss
	82	Option Card Communication Loss
	83	Embedded EtherNet/IP Adapter Communication Loss
91	Encoder Loss	
94	Function Loss	
100	Parameter Checksum Error	
101	External Storage	
105	Control Module Connect Error	
106	Incompatible Control-Power Module	
107	Unrecognized Control-Power Module	
109	Mismatched Control-Power Module	
110	Keypad Membrane	
111	Safety Hardware	
114	Microprocessor Failure	
122	I/O Board Fail	

Drive Error Codes

Logic Status		
Address (Decimal)	Value (Decimal)	Description
2101H (8449)	125	Flash Update Required
	126	Non Recoverable Error
	127	DSI Flash Update Required

Reading (03) Drive Operational Values

The PowerFlex 520-series Drive Operational Values can be read through the network by sending Function Code 03 reads to register addresses 2102H...210AH.

Drive Operational Values

Reference	
Address (Decimal)	Description
2102H (8450)	Frequency Command (xxx.xx Hz)
2103H (8451)	Output Frequency (xxx.xx Hz)
2104H (8452)	Output Current (xxx.xx A)
2105H (8453)	DC-BUS Voltage (xxxV)
2106H (8454)	Output Voltage (xxx.xV)

Reading (03) and Writing (06) Drive Parameters

To access drive parameters, the Modbus register address equals the parameter number. For example, a decimal “1” is used to address Parameter b001 [Output Freq] and decimal “41” is used to address Parameter P041 [Accel Time 1].

Additional Information

See <http://www.ab.com/drives/> for additional information.

Velocity StepLogic, Basic Logic and Timer/Counter Functions

Four PowerFlex 520-series logic functions provide the capability to program simple logic functions without a separate controller.

- Velocity StepLogic™ Function (specific to PowerFlex 525 drives only)

Steps through up to eight preset speeds based on programmed logic. Programmed logic can include conditions that need to be met from digital inputs programmed as “Logic In 1” and “Logic In 2” before stepping from one preset speed to the next. A timer is available for each of the eight steps and is used to program a time delay before stepping from one preset speed to the next. The status of a digital output can also be controlled based on the step being executed.

- Basic Logic Function (specific to PowerFlex 525 drives only)

Up to two digital inputs can be programmed as “Logic In 1” and/or “Logic In 2”. A digital output can be programmed to change state based on the condition of one or both inputs based on basic logic functions such as AND, OR, NOR. The basic logic functions can be used with or without StepLogic.

- Timer Function

A digital input can be programmed for “Timer Start”. A digital output can be programmed as a “Timer Out” with an output level programmed to the desired time. When the timer reaches the time programmed into the output level the output will change state. The timer can be reset with a digital input programmed as “Reset Timer”.

- Counter Function

A digital input can be programmed for “Counter In”. A digital output can be programmed as “Counter Out” with an output level programmed to the desired number of counts. When the counter reaches the count programmed into the output level the output will change state. The counter can be reset with a digital input programmed as “Reset Counter”.

TIP Use the Wizard in Connected Components Workbench to simplify setup instead of manually configuring the parameters.

Velocity StepLogic Using Timed Steps

IMPORTANT This function is specific to PowerFlex 525 drives only.

To activate this function, set one of the three speed reference sources, parameter P047, P049 or P051 [Speed Referencex] to 13 “Step Logic” and activate that speed reference source. Three parameters are used to configure the logic, speed reference and time for each step.

- Logic is defined using parameters L180...L187 [Stp Logic x].
- Preset Speeds are set with parameters A410...A417 [Preset Freq 0...7].
- Time of operation for each step is set with parameters L190...L197 [Stp Logic Time x].

The direction of motor rotation can be forward or reverse.

Using Timed Steps

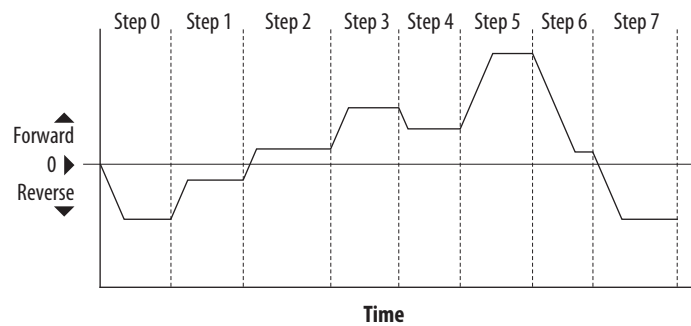

Velocity StepLogic Sequence

- Sequence begins with a valid start command.
- A normal sequence begins with Step 0 and transition to the next step when the corresponding StepLogic time has expired.
- Step 7 is followed by Step 0
- Sequence repeats until a stop is issued or a fault condition occurs.

Velocity StepLogic Using Basic Logic Functions

IMPORTANT This function is specific to PowerFlex 525 drives only.

Digital input and digital output parameters can be configured to use logic to transition to the next step. Logic In 1 and Logic In 2 are defined by programming parameters t062...t063, t065...t068 [DigIn TermBlk xx] to 24 “Logic In 1” or 25 “Logic In 2”.

Example

- Run at Step 0.
- Transition to Step 1 when Logic In 1 is true.
Logic senses the edge of Logic In 1 when it transitions from off to on.
Logic In 1 is not required to remain “on”.

- Transition to Step 2 when both Logic In 1 and Logic In 2 are true. The drive senses the level of both Logic In 1 and Logic In 2 and transitions to Step 2 when both are on.
- Transition to Step 3 when Logic In 2 returns to a false or off state. Inputs are not required to remain in the “on” condition except under the logic conditions used for the transition from Step 2 to Step 3.

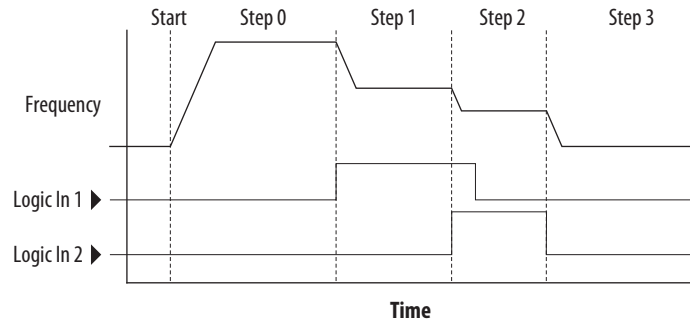

The step time value and the basic logic may be used together to satisfy machine conditions. For instance, the step may need to run for a minimum time period and then use the basic logic to trigger a transition to the next step.

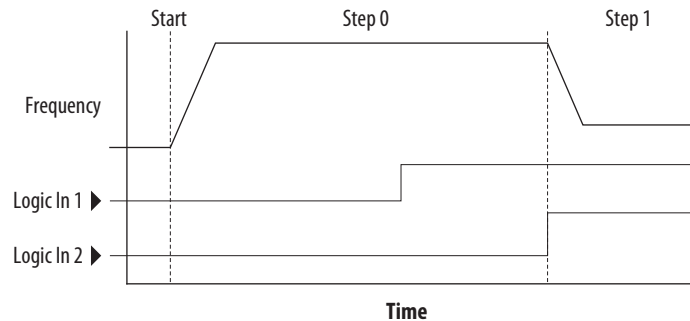

Timer Function

Digital inputs and outputs control the timer function and are configured with parameters t062...t063, t065...t068 [DigIn TermBlk xx] set to 19 “Timer Start” and 21 “Reset Timer”.

Digital outputs (relay and opto type) define a preset level and indicate when the level is reached. Level parameters t077 [Relay Out1 Level], t082 [Relay Out2 Level], t070 [Opto Out1 Level] and t073 [Opto Out2 Level] are used to set the desired time in seconds.

Parameters t076 [Relay Out1 Sel], t081 [Relay Out2 Sel], t069 [Opto Out1 Sel] and t072 [Opto Out2 Sel] are set to 25 “Timer Out” and causes the output to change state when the preset level is reached.

Example

- Drive starts up and accelerates to 30 Hz.
- After 30 Hz has been maintained for 20 seconds, a 4-20 mA analog input becomes the reference signal for speed control.

- The timer function is used to select a preset speed with a 20 second run time that overrides the speed reference while the digital input is active.
- Parameters are set to the following options:
 - P047 [Speed Reference1] = 6 “4-20mA Input”
 - P049 [Speed Reference2] = 7 “Preset Freq”
 - t062 [DigIn TermBlk 02] = 1 “Speed Ref 2”
 - t063 [DigIn TermBlk 03] = 19 “Timer Start”
 - t076 [Relay Out1 Sel] = 25 “Timer Out”
 - t077 [Relay Out1 Level] = 20.0 Secs
 - A411 [Preset Freq 1] = 30.0 Hz
- The control terminal block is wired such that a start command will also trigger the timer start.
- The relay output is wired to I/O Terminal 02 (DigIn TermBlk 02) so that it forces the input on when the timer starts.
- After the timer is complete, the output is turned off releasing the preset speed command. The drive defaults to following the analog input reference as programmed.

Note that a “Reset Timer” input is not required for this example since the “Timer Start” input both clears and starts the timer.

Counter Function

Digital inputs and outputs control the counter function and are configured with parameters t062...t063, t065...t068 [DigIn TermBlk xx] set to 20 “Counter In” and 22 “Reset Countr”.

Digital outputs (relay and opto type) define a preset level and indicate when the level is reached. Level parameters t077 [Relay Out1 Level], t082 [Relay Out2 Level], t070 [Opto Out1 Level] and t073 [Opto Out2 Level] are used to set the desired count value.

Parameters t076 [Relay Out1 Sel], t081 [Relay Out2 Sel], t069 [Opto Out1 Sel] and t072 [Opto Out2 Sel] are set to 26 “Counter Out” which causes the output to change state when the level is reached.

Example

- A photo eye is used to count packages on a conveyor line.
- An accumulator holds the packages until 5 are collected.
- A diverter arm redirects the group of 5 packages to a bundling area.
- The diverter arm returns to its original position and triggers a limit switch that resets the counter.
- Parameters are set to the following options:
 - t065 [DigIn TermBlk 05] = 20 “Counter In”
 - t066 [DigIn TermBlk 06] = 22 “Reset Countr”
 - t076 [Relay Out1 Sel] = 26 “Counter Out”
 - t077 [Relay Out1 Level] = 5.0 Counts

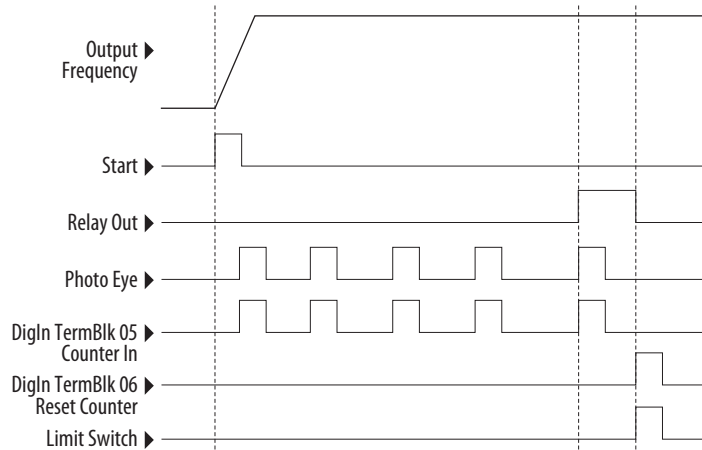

Velocity StepLogic Parameters

Code Descriptions for Parameters L180...L187

Digit 4	Digit 3	Digit 2	Digit 1
0	0	F	1

Digit 4 – Defines the action during the step currently executing

Setting	Accel/Decel Parameter Used	StepLogic Output State	Commanded Direction
0	1	Off	FWD
1	1	Off	REV
2	1	Off	No Output
3	1	On	FWD
4	1	On	REV
5	1	On	No Output
6	2	Off	FWD
7	2	Off	REV
8	2	Off	No Output
9	2	On	FWD
A	2	On	REV
b	2	On	No Output

Digit 3 – Defines what step to jump to or how to end program when the logic conditions specified in Digit 2 are met.

Setting	Logic
0	Jump to Step 0
1	Jump to Step 1
2	Jump to Step 2
3	Jump to Step 3
4	Jump to Step 4
5	Jump to Step 5
6	Jump to Step 6
7	Jump to Step 7
8	End Program (Normal Stop)
9	End Program (Coast to Stop)
A	End Program and Fault (F002)

Digit 2 – Defines what logic must be met to jump to a step other than the very next step.

Setting	Description	Logic
0	Skip Step (jump immediately)	SKIP
1	Step based on the time programmed in the respective [Stp Logic Time x] parameter.	TIMED
2	Step if "Logic In 1" is active (logically true)	TRUE
3	Step if "Logic In 2" is active (logically true)	TRUE
4	Step if "Logic In 1" is not active (logically false)	FALSE
5	Step if "Logic In 2" is not active (logically false)	FALSE
6	Step if either "Logic In 1" or "Logic In 2" is active (logically true)	OR
7	Step if both "Logic In 1" and "Logic In 2" is active (logically true)	AND
8	Step if neither "Logic In 1" or "Logic In 2" is active (logically true)	NOR
9	Step if "Logic In 1" is active (logically true) and "Logic In 2" is not active (logically false)	XOR
A	Step if "Logic In 2" is active (logically true) and "Logic In 1" is not active (logically false)	XOR
b	Step after [Stp Logic Time x] and "Logic In 1" is active (logically true)	TIMED AND
C	Step after [Stp Logic Time x] and "Logic In 2" is active (logically true)	TIMED AND
d	Step after [Stp Logic Time x] and "Logic In 1" is not active (logically false)	TIMED OR
E	Step after [Stp Logic Time x] and "Logic In 2" is not active (logically false)	TIMED OR
F	Do not step OR no "jump to", so use Digit 0 logic	IGNORE

Digit 1 – Defines what logic must be met to jump to the very next step.

Setting	Description	Logic
0	Skip Step (jump immediately)	SKIP
1	Step based on the time programmed in the respective [Stp Logic Time x] parameter.	TIMED
2	Step if "Logic In 1" is active (logically true)	TRUE
3	Step if "Logic In 2" is active (logically true)	TRUE
4	Step if "Logic In 1" is not active (logically false)	FALSE
5	Step if "Logic In 2" is not active (logically false)	FALSE
6	Step if either "Logic In 1" or "Logic In 2" is active (logically true)	OR
7	Step if both "Logic In 1" and "Logic In 2" is active (logically true)	AND
8	Step if neither "Logic In 1" or "Logic In 2" is active (logically true)	NOR
9	Step if "Logic In 1" is active (logically true) and "Logic In 2" is not active (logically false)	XOR
A	Step if "Logic In 2" is active (logically true) and "Logic In 1" is not active (logically false)	XOR
b	Step after [Stp Logic Time x] and "Logic In 1" is active (logically true)	TIMED AND
C	Step after [Stp Logic Time x] and "Logic In 2" is active (logically true)	TIMED AND
d	Step after [Stp Logic Time x] and "Logic In 1" is not active (logically false)	TIMED OR
E	Step after [Stp Logic Time x] and "Logic In 2" is not active (logically false)	TIMED OR
F	Use logic programmed in Digit 1	IGNORE

Encoder/Pulse Train Usage and Position StepLogic Application

Encoder and Pulse Train Usage

The PowerFlex 520-series drives include a pulse train input built into the terminal block. PowerFlex 525 drives also support an optional encoder card. The pulse train and encoder can be used for many of the same functions, but the pulse train supports up to 100 kHz at 24V, and uses the drive built-in terminal block. The encoder supports up to 250 kHz dual channel at 5, 12 or 24V and requires the optional encoder board to be installed. When [A535](#) [Motor Fdbk Type] is set to a value other than zero, the drive is set to use an encoder or pulse train. The drive will use the encoder or pulse train in several ways depending on the settings of other parameters. The drive will use the encoder or pulse train as shown below (listed in order of priority):

1. If enabled by [P047](#), [P049](#), or [P051](#) [Speed Referencex], the encoder or pulse train will be used directly as a commanded speed (normally used with a pulse train) or as a position reference (normally used with a quadrature encoder).
2. If not enabled by the Speed Reference parameters, the encoder or pulse train can be used with the PID function if enabled by [A459](#) or [A471](#) [PID x Ref Sel], or [A460](#) or [A472](#) [PID x Fdbk Sel].
3. If not enabled by the Speed Reference or PID function parameters, the encoder or pulse train can be used with [A535](#) [Motor Fdbk Type] for direct feedback and trim of the speed command. The normal slip compensation is not used in this case. Instead the drive will use the encoder or pulse train to determine actual output frequency and adjust the output frequency to match the command. Parameters [A538](#) [Ki Speed Loop] and [A539](#) [Kp Speed Loop] are used in this control loop. The primary benefit of this mode is increased speed accuracy when compared to open-loop slip compensation. It does not provide speed bandwidth improvement.

IMPORTANT The encoder usage, and position StepLogic application covered in this chapter is specific to PowerFlex 525 drives only.

Encoder Interface

The incremental encoder option card can source 5 or 12 volt power and accept 5, 12 or 24 volt single ended or differential inputs. See [Appendix B](#) for ordering information.

No.	Signal	Description
+V	5...12V Power ⁽¹⁾⁽²⁾	Internal power source 250 mA (isolated).
Cm	Power Return	
B-	Encoder B (NOT)	Quadrature B input.
B	Encoder B	
A-	Encoder A (NOT)	Single channel, pulse train or quadrature A input.
A	Encoder A	
①	Output	DIP switch selects 12 or 5 volt power supplied at terminals "+V" and "Cm" for the encoder.

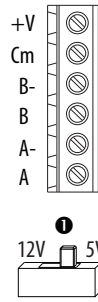

- (1) When using 12V Encoder power, 24V I/O power, maximum output current at I/O Terminal 11 is 50 mA.
- (2) If Encoder requires 24V power, it must be supplied by an external power source.

Encoder Wiring Examples

I/O	Connection Example	I/O	Connection Example
Encoder Power – Internal Drive Power Internal (drive) 12V DC, 250mA		Encoder Power – External Power Source	
Encoder Signal – Single-Ended, Dual Channel		Encoder Signal – Differential, Dual Channel	

Wiring Notes

The encoder option card can supply 5V or 12V power (250 mA maximum) for an encoder. Be sure the DIP switch is set properly for the encoder. In general, 12V will provide higher noise immunity.

The encoder can handle 5V, 12V, or 24V inputs, but the pulse train can handle only 24V inputs. The inputs will automatically adjust to the voltage applied and no additional drive adjustment is necessary. If a single-channel input is used, it must be wired between the A (signal) and A- (signal common) channels.

IMPORTANT

A quadrature encoder provides rotor speed and direction. Therefore, the encoder must be wired such that the forward direction matches the motor forward direction. If the drive is reading encoder speed but the position regulator or other encoder function is not working properly, remove power to the drive, then do one of the following:

- Swap the A and A (NOT) encoder channels.
- Swap the B and B (NOT) encoder channels.
- Swap any two motor leads.

Drives will fault when an encoder is incorrectly wired and [A535](#) [Motor Fdbk Type] is set to 5 "Quad Check".

Positioning Overview

The PowerFlex 525 drive includes a simple position regulator which can be used in a variety of position applications without the need for multiple limit switches or photo-eyes. This can be used as a stand-alone controller for simple applications (up to 8 positions) or in conjunction with a controller for more flexibility.

Please note that this is not intended to replace high end servo controllers or any application that needs high bandwidth or very high torque at low speeds.

Common Guidelines for All Applications

The position regulator can be configured for operation appropriate for a variety of applications. Certain parameters will need to be adjusted in all cases.

[P047](#) [Speed Reference1] must be set to 16 “Positioning”.

[A535](#) [Motor Fdbk Type] must be set to match the feedback device. Positioning mode must use [A535](#) [Motor Fdbk Type] option 4.

[A535](#) [Motor Fdbk Type] Options

0 “None” indicates no encoder is used. This can not be used for positioning.

1 “Pulse Train” is a single channel input, no direction, speed feedback only. This should not be used for positioning. The Single Channel selection is similar to a Pulse Train, but uses the standard encoder scaling parameters.

2 “Single Chan” is a single channel input, no direction, speed feedback only. This should not be used for positioning. Single channel uses the standard encoder scaling parameters.

3 “Single Check” is a single channel input with encoder signal loss detection. The drive will fault if it detects that the input pulses do not match the expected motor speed. This should not be used for positioning.

4 “Quadrature” is a dual channel encoder input with direction and speed from the encoder. This may be used for positioning control.

5 “Quad Check” is a dual channel encoder with encoder signal loss detection. The drive will fault if it detects that the encoder speed does not match the expected motor speed.

[A544](#) [Reverse Disable] should be set to 0 “Rev Enabled” to allow bidirectional movement necessary for position control.

[P039](#) [Torque Perf Mode] default setting is 1 “SVC”. However, any mode can be used to improve the low speed torque for positioning applications. For best results, tune the application first. The autotune routine can be completed to further improve the drive-motor performance.

[A550](#) [Bus Reg Enable] default setting is 1 “Enabled”. If the deceleration time is too short, the drive may overshoot the desired position. For best results, a longer deceleration time may be necessary. [A550](#) [Bus Reg Enable] can be disabled to provide precise stopping movements, but the deceleration time will need to be manually tuned so that it is long enough to avoid F005 “OverVoltage” faults.

[A437](#) [DB Resistor Sel] default setting is 0 “Disabled”. If improved deceleration performance is required a Dynamic Brake resistor can be used. If used, this parameter should be set to the appropriate setting for the resistor selected.

[P035](#) [Motor NP Poles] must be set to match the number of motor poles on the motor driven by the PowerFlex 520-series drive.

[A536](#) [Encoder PPR] must be set to match the number of pulses per revolution of the encoder used (i.e., 1024 PPR Encoder).

[A559](#) [Counts Per Unit] sets the number of encoder counts that will be used to define one position unit. This allows the encoder positions to be defined in terms of units important to the application. For example, if 1cm of travel on a conveyor belt requires 0.75 turns of the motor, the motor encoder is 1024 PPR, and the Motor Feedback type is set to Quadrature, then this parameter would need to be set to $(4 \times 1024 \times 0.75) = 3072$ counts for one cm of travel. Then all other positions could be setup in units of “cm”.

[A564](#) [Encoder Pos Tol] indicates the desired position tolerance for the system. This will determine how close the drive must be to the commanded position before the drive will indicate “At Home” or “At Position” in units of raw encoder pulses. This has no effect on the actual positioning control of the motor.

Positioning Operation

Parameter [A558](#) [Positioning Mode] must be set to properly match the desired operation of the positioning function.

[A558](#) [Positioning Mode] Options

0 “Time Steps” uses Step Logic times. This mode ignores the Step Logic settings and moves through the steps (Step 0 to Step 7 and back to Step 0) based on the times programmed into [L190...L197](#) [Stp Logic Time x]. This can be used when the desired position is based only on time. In addition, this mode only accepts absolute positions in a positive direction from “home”. This option provides an easy way to implement a simple positioning program or to test the basic positioning setup. For additional flexibility one of the other settings should be used.

1 “Preset Input” directly commands movement to any step based on the status of the digital inputs programmed for “Preset Freq”. This setting ignores the Step Logic Commands settings and instead the drive will move directly to whatever step is currently commanded by [A410...A425](#) [Preset Freq x] and [L200...L214](#) [Step Units x]. This is useful when an application

needs direct access to any position step based on discrete inputs. This mode moves in the forward direction from Home and is an absolute move.

IMPORTANT Advanced Step Logic options such as incremental move are not available in this mode.

2 “Step Logic” provides a highly flexible mode of operation. This can be used to move through the steps (Step 0 to Step 7 and back to Step 0) or can jump to a different step at any time based on time or the status of digital inputs or communication commands. In this mode the drive always starts at Step 0 of the Step Logic profile.

3 “Preset StpL” is identical to 2 “Step Logic” except the drive will use the current status of the Preset Inputs to determine which Step Logic step to begin. This only affects the initial step. After start, the drive will move through the steps in the same manner as if setting 2 was selected.

4 “StpLogic-Lst” is identical to 2 “Step Logic” except the drive will use the step prior to its last stop command to determine which Step Logic step to begin. This only affects the initial step. After start, the drive will move through the steps in the same manner as if setting 2 was selected. This allows a process to be stopped and then restarted at the position where it stopped.

In all position modes, the following parameters will control the characteristics at each step:

[L200](#), [L202](#), [L204](#), [L206](#), [L208](#), [L210](#), [L212](#) and [L214](#) [Step Units x] are the number value to the left of the decimal (whole number) of the 8 positions desired for an application, beginning with Step 0 (L200) and continuing with each step until Step 7 (L214). For example, enter 2 into this parameter if you would like a commanded position of 2.77.

L201, L203, L205, L207, L209, L211, L213 and L215 [Step Units F x] are the number value to the right of the decimal (the portion less than 1) of the 8 positions desired for an application, beginning with Step 0 (L201) and continuing with each step until Step 7 (L215). For example, enter 0.77 into this parameter if you would like a commanded position of 2.77.

[A410...A417](#) [Preset Freq x] are the parameters that define the maximum frequency the drive will run at during the corresponding step. For example, if [Preset Freq 2] is set to 40 Hz, the drive will accelerate to 40 Hz maximum when moving to Position 2.

Frequency Source	Step Source	Position Source
A410 [Preset Freq 0]	L180 [Stp Logic 0]	L200 [Step Units 0]
A411 [Preset Freq 1]	L181 [Stp Logic 1]	L202 [Step Units 1]
A412 [Preset Freq 2]	L182 [Stp Logic 2]	L204 [Step Units 2]
A413 [Preset Freq 3]	L183 [Stp Logic 3]	L206 [Step Units 3]
A414 [Preset Freq 4]	L184 [Stp Logic 4]	L208 [Step Units 4]

Frequency Source	Step Source	Position Source
A415 [Preset Freq 5]	L185 [Stp Logic 5]	L210 [Step Units 5]
A416 [Preset Freq 6]	L186 [Stp Logic 6]	L212 [Step Units 6]
A417 [Preset Freq 7]	L187 [Stp Logic 7]	L214 [Step Units 7]

IMPORTANT The default value for [A410](#) [Preset Freq 0] is 0.00 Hz. This value needs to be changed or the drive will not be able to move during Step 0.

[L190...L197](#) [Stp Logic Time x] are the parameters that define the time the drive will remain in each corresponding step if that step is time-based. For example, if [L192](#) [Stp Logic Time 2] is set to 5.0 seconds and that step is time-based, the drive will remain in Step 2 for 5.0 seconds. Note that this is the total time in that step, not the time at that position. Therefore, it will include the time needed to accelerate, run, and decelerate to that position.

[L180...L187](#) [Stp Logic x] are the parameters that allow additional flexibility and control various aspects of each step when a positioning mode is selected that utilizes the Step Logic functions. Note that in Positioning mode these parameters have a different function than when used for normal velocity Step Logic. Each of the 4 digits controls one aspect of the each position step. The following is a listing of the available settings for each digit:

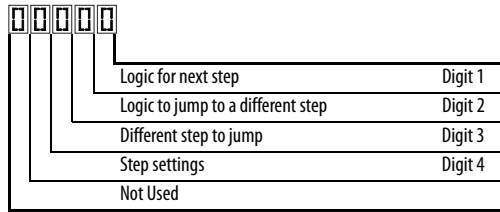
**Velocity Control Settings (Digit 4)**

Required Setting	Accel/Decel Param. Used	StepLogic Output State	Commanded Direction
0	Accel/Decel 1	Off	FWD
1	Accel/Decel 1	Off	REV
2	Accel/Decel 1	Off	No Output
3	Accel/Decel 1	On	FWD
4	Accel/Decel 1	On	REV
5	Accel/Decel 1	On	No Output
6	Accel/Decel 2	Off	FWD
7	Accel/Decel 2	Off	REV
8	Accel/Decel 2	Off	No Output
9	Accel/Decel 2	On	FWD
A	Accel/Decel 2	On	REV
b	Accel/Decel 2	On	No Output

Positioning Settings (Digit 4)

Required Setting	Accel/Decel Param. Used	StepLogic Output State	Direction From Home	Type of Command
0	Accel/Decel 1	Off	FWD	Absolute
1	Accel/Decel 1	Off	FWD	Incremental
2	Accel/Decel 1	Off	REV	Absolute
3	Accel/Decel 1	Off	REV	Incremental
4	Accel/Decel 1	On	FWD	Absolute
5	Accel/Decel 1	On	FWD	Incremental
6	Accel/Decel 1	On	REV	Absolute
7	Accel/Decel 1	On	REV	Incremental
8	Accel/Decel 2	Off	FWD	Absolute
9	Accel/Decel 2	Off	FWD	Incremental
A	Accel/Decel 2	Off	REV	Absolute
b	Accel/Decel 2	Off	REV	Incremental
C	Accel/Decel 2	On	FWD	Absolute
d	Accel/Decel 2	On	FWD	Incremental
E	Accel/Decel 2	On	REV	Absolute
F	Accel/Decel 2	On	REV	Incremental

Settings (Digit 3)

Setting	Description
0	Jump to Step 0
1	Jump to Step 1
2	Jump to Step 2
3	Jump to Step 3
4	Jump to Step 4
5	Jump to Step 5
6	Jump to Step 6
7	Jump to Step 7
8	End Program (Normal Stop)
9	End Program (Coast to Stop)
A	End Program and Fault (F2)

Settings (Digit 2 and 1)

Setting	Description
0	Skip Step (Jump Immediately)
1	Step Based on [Stp Logic Time x]
2	Step if "Logic In 1" is Active
3	Step if "Logic In 2" is Active
4	Step if "Logic In 1" is Not Active
5	Step if "Logic In 2" is Not Active
6	Step if either "Logic In 1" or "Logic In 2" is Active
7	Step if both "Logic In 1" and "Logic In 2" are Active
8	Step if neither "Logic In 1" nor "Logic In 2" is Active
9	Step if "Logic In 1" is Active and "Logic In 2" is Not Active
A	Step if "Logic In 2" is Active and "Logic In 1" is Not Active
b	Step after [Stp Logic Time x] and "Logic In 1" is Active
C	Step after [Stp Logic Time x] and "Logic In 2" is Active
d	Step after [Stp Logic Time x] and "Logic In 1" is Not Active
E	Step after [Stp Logic Time x] and "Logic In 2" is Not Active
F	Do Not Step/Ignore Digit 2 Settings

TIP Use the Wizard in Connected Components Workbench to simplify setup instead of manually configuring the parameters.

Note: Incremental move commands will cause the drive to move the amount specified based on the current position. Absolute commands are always with reference to "Home".

[A565](#) [Pos Reg Filter] provides a low pass filter at the input of the position regulator.

[A566](#) [Pos Reg Gain] is a single adjustment for increasing or decreasing the responsiveness of the position regulator. For faster response, the filter should be reduced and/or the gain should be increased. For smoother response with less

overshoot, the filter should be increased and/or the gain should be reduced. In general, the gain will have a larger effect on most systems than the filter.

Homing Routine

This drive supports incremental encoders only. Therefore, when the drive powers up it will reset the current position to zero. If this is known to be correct the position routine can be started without further adjustment. However, in most applications the drive will need to be “homed” after each power-up and prior to starting the position routine.

This can be accomplished in one of the following two ways:

1. Manual Homing—Program the following drive parameters:

[r062](#), [r063](#), [r065...r068](#) [DigIn TermBlk xx] = 37 “Pos Redefine”

Program one of the digital inputs to 37 “Pos Redefine”. Then, move the system into the home position with a run command, a jog command, or by manually moving the system into the home position. Then, toggle the “Pos Redefine” input. This will set the drive to “Home” at its current position and [d388](#) [Units Traveled H] and [d389](#) [Units Traveled L] are set to zero. Alternately, the “Pos Redefine” bit in [A560](#) [Enh Control Word] can be toggled instead of utilizing a digital input.

IMPORTANT The “Pos Redefine” input or bit must be returned to inactive before starting the position routine. Otherwise the drive will continuously read a position of “0” (home) and the position routine will not function correctly.

2. Automatic Homing to Limit Switch—Program the following drive parameters:

[r062](#), [r063](#), [r065...r068](#) [DigIn TermBlk xx] = 35 “Find Home”
Program one of the digital inputs to 35 “Find Home”.

[r062](#), [r063](#), [r065...r068](#) [DigIn TermBlk xx] = 34 “Home Limit”
Program one of the digital inputs to 34 “Home Limit”. Normally, the “Home Limit” input would be wired to a proximity switch or photo-eye and will indicate the system is in the home position.

[A562](#) [Find Home Freq] sets the frequency the drive will use while it is moving to the home position during the automatic homing routine.

[A563](#) [Find Home Dir] sets the direction the drive will use while it is moving to the home position during the automatic homing routine.

To begin the automatic homing routine, activate the “Find Home” input and then initiate a valid start command. The drive will then ramp to the speed set in [A562](#) [Find Home Freq] and in the direction set in [A563](#) [Find Home Dir] until the digital input defined as “Home Limit” is activated. If the drive passes this

point too quickly it will then reverse direction at 1/10th [A562](#) [Find Home Freq] to the point where the Home Limit switch reactivates. Approximately one second after the routine finds home the drive will stop. Alternately, the “Find Home Freq” and/or “Home Limit” bits in [A560](#) [Enh Control Word] can be activated instead of utilizing a digital input. The inputs or bits should be returned to inactive after the routine is complete.

IMPORTANT After the position is reached the drive will stop. If the Find Home is removed before the homing is complete, the drive will begin running the position routine without the proper home. In this case Home will not be reset and the position will be in relation to the power up position.

Encoder and Position Feedback

[d376](#) [Speed Feedback] indicates the measured speed feedback or the calculated speed feedback when no feedback device is selected. Parameter [d376](#) [Speed Feedback] is the number value to the left of the decimal (whole number) and [d377](#) [Speed Feedback F] is the value to the right of the decimal (the portion less than 1).

[d378](#) [Encoder Speed] indicates the measured speed of the feedback device. This is useful if the encoder is not used for motor speed control. However, the encoder must be used for some purpose in order for [d378](#) [Encoder Speed] to indicate a value. Parameter [d378](#) [Encoder Speed] is the number value to the left of the decimal (whole number) and [d379](#) [Encoder Speed F] is the number to the right of the decimal (the portion less than 1).

[d388](#), [d389](#) [Units Traveled x] indicate the current position of the system in terms of units away from Home. Parameter [d388](#) [Units Traveled H] is the number value to the left of the decimal (whole number) and [d389](#) [Units Traveled L] is the number to the right of the decimal (the portion less than 1).

[d387](#) [Position Status] indicates the status of the positioning functions. The indication bits are:

Bit 0 “Dir Positive” indicates the current direction the drive has moved from Home.

Bit 1 “At Position” indicates whether the drive is at its commanded position. If the drive is within [A564](#) [Encoder Pos Tol] of the commanded position, this bit will be active.

Bit 2 “At Home” indicates whether the drive is at Home. If the drive is within [A564](#) [Encoder Pos Tol] of “Home”, this bit will be active.

Bit 3 “Drive Homed” indicates whether the drive has been homed since power-up. This bit will be active once the drive has been homed either manually or automatically. It will remain active until the next power down.

Use Over Communications

If 8 steps are not adequate for the application or if dynamic program changes are required, many of the positioning functions can be controlled through an active communication network. The following parameters will allow this control.

[C121](#) [Comm Write Mode]

Repeated writes to parameters over a communication network can cause damage to the drive EEPROM. This parameter allows the drive to accept parameter changes without writing to the EEPROM.

IMPORTANT Parameter values set prior to setting 1 “RAM only” are saved in RAM.

[C122](#) [Cmd Stat Select]

Selects velocity-specific or position/fibers-specific Command and Status Word bit definitions for use over a communication network.

[A560](#) [Enh Control Word]

This parameter allows many of the positioning functions to be completed through parameter control using an explicit message. This allows the operation over communications instead of with hardware inputs. The bits have the same functions as the digital input options of the same name. Options relating to positioning are:

Bit 0 “Home Limit” indicates the drive is at the home position.

Bit 1 “Find Home” causes the drive to find home at the next start command. Deactivate this bit after completing the homing routine.

Bit 2 “Hold Step” overrides other inputs and causes the drive to remain at its current step (running at zero speed once it reaches its position) until released.

Bit 3 “Pos Redefine” resets the home position to the current position of the machine. Deactivate this bit after completing the homing routine.

Bit 4 “Sync Enable” holds the existing frequency when A571 [Sync Time] is set to enable speed synchronization. When this bit is deactivated the drive will accelerate to the new commanded frequency based on A571 [Sync Time].

Bit 5 “Traverse Dis” disables the traverse function when this bit is active.

Bit 6 “Logic In 1” provides an identical function and is logically ORed with setting 24 “Logic In 1” for [r062](#), [r063](#), [r065...r068](#) [DigIn TermBlk xx]. It can be used to move through the Step Logic functions (speed or position) using comms control without requiring actual digital input transitions.

Bit 7 “Logic In 2” provides an identical function and is logically ORed with setting 25 “Logic In 2” for [r062](#), [r063](#), [r065...r068](#) [DigIn TermBlk xx]. It can be used to move through the Step Logic functions (speed or

position) using comms control without requiring actual digital input transitions.

[L200...L214](#) [Step Units x]

All of the position steps can be written to while the drive is running. The changes will take place at the next move. For example, if step 0 is over-written while the drive is moving to step 0, the drive will move to the previous commanded position at step 0. The next time the drive is commanded to return to step 0 it will proceed to the new position. One possible use of this capability is when an application requires full control of the movement by a controller external to the drive. The Step Logic program might be written to jump from step 0 back to step 0 when Input 1 is active. The controller could write any desired position to step 0 and then toggle the input 1 bit of [A560](#) [Enh Control Word] to cause the drive to move to the new position. This allows almost unlimited flexibility and can be used with absolute or incremental moves.

Setup Notes

The RA computer tool (Connected Components Workbench) can make setup of the positioning functions much easier. Refer to the latest versions for additional tools or wizards which can aid in the setup.

Notes:

PID Set Up

PID Loop

The PowerFlex 520-series drive features built-in PID (proportional, integral, derivative) control loops. The PID loop is used to maintain a process feedback (such as pressure, flow or tension) at a desired set point. The PID loop works by subtracting the PID feedback from a reference and generating an error value. The PID loop reacts to the error, based on the PID Gains, and outputs a frequency to try to reduce the error value to 0.

To enable the PID loop, [P047](#), [P049](#) or [P051](#) [Speed Reference] must be set to 11 “PID1 Output” or 12 “PID2 Output”, and the corresponding speed reference activated.

IMPORTANT PowerFlex 523 has one PID control loop.
PowerFlex 525 has two PID control loops, of which only one can be in use at any time.

Exclusive Control and Trim Control are two basic configurations where the PID loop may be used.

Exclusive Control

In Exclusive Control, the Speed Reference becomes 0, and the PID Output becomes the entire Freq Command. Exclusive Control is used when [A458](#) or [A470](#) [PID x Trim Sel] is set to option 0. This configuration does not require a master reference, only a desired set point, such as a flow rate for a pump.

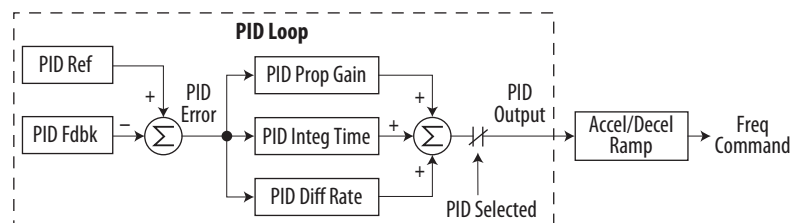

Example

- In a pumping application, the PID Reference equals the Desired System Pressure set point.
- The Pressure Transducer signal provides PID Feedback to the drive. Fluctuations in actual system pressure, due to changes in flow, result in a PID Error value.
- The drive output frequency increases or decreases to vary motor shaft speed to correct for the PID Error value.

- The Desired System Pressure set point is maintained as valves in the system are opened and closed causing changes in flow.
- When the PID Control Loop is disabled, the Commanded Speed is the Ramped Speed Reference.

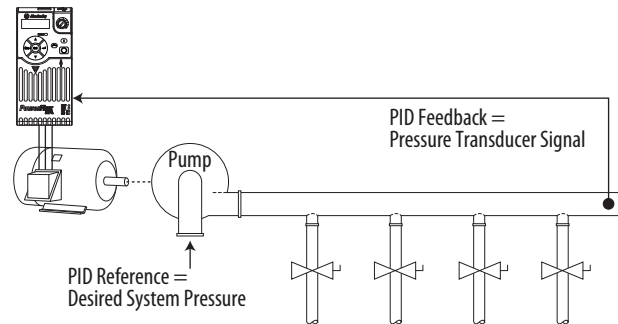

Trim Control

In Trim Control, the PID Output is added to the Speed Reference. In Trim mode, the output of the PID loop bypasses the accel/decel ramp as shown. Trim Control is used when [A458](#) or [A470](#) [PID x Trim Sel] is set to any option other than 0.

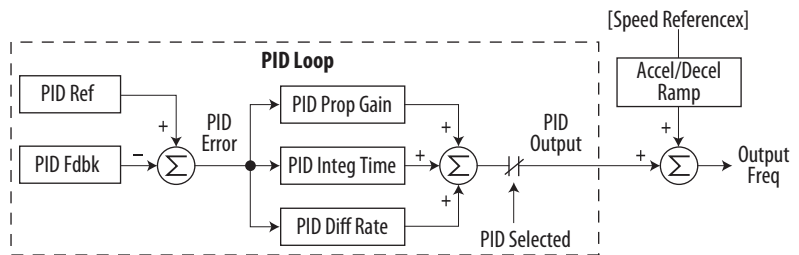

Example

- In a winder application, the PID Reference equals the Equilibrium set point.
- The Dancer Pot signal provides PID Feedback to the drive. Fluctuations in tension result in a PID Error value.
- The Master Speed Reference sets the wind/unwind speed.

- As tension increases or decreases during winding, the Speed Reference is trimmed to compensate. Tension is maintained near the Equilibrium set point.

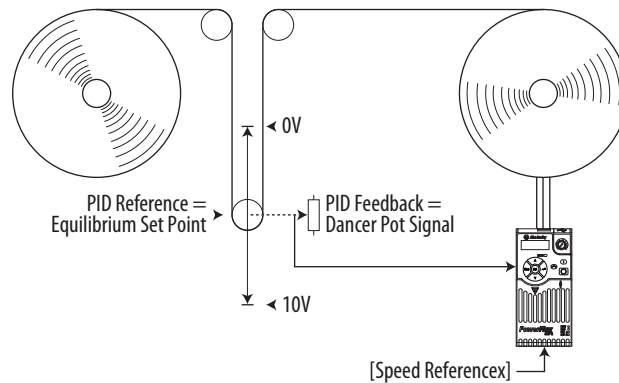

PID Reference and Feedback

PID mode is enabled by setting [P047](#), [P049](#) or [P051](#) [Speed Reference_x] to 11 “PID1 Output” or 12 “PID2 Output”, and activating the corresponding speed reference.

IMPORTANT PowerFlex 523 has one PID control loop.
PowerFlex 525 has two PID control loops, of which only one can be in use at any time.

If [A459](#) or [A471](#) [PID x Ref Sel] is not set to 0 “PID Setpoint”, PID can still be disabled by select programmable digital input options (parameters [t062](#), [t063](#), [t065...t068](#) [DigIn TermBlk xx]) such as “Purge”.

A459, A471 [PID x Ref Sel] Options

Options	Description
0 “PID Setpoint”	A464 or A476 [PID x Setpoint] will be used to set the value of the PID Reference.
1 “Drive Pot”	The drive potentiometer will be used to set the value of the PID Reference.
2 “Keypad Freq”	The drive keypad will be used to set the value of the PID Reference.
2 “Serial/DSI”	The reference word from the Serial/DSI communication network becomes the PID Reference.
4 “Network Opt”	The reference word from a communication network option becomes the PID Reference.
5 “0-10V Input”	Selects the 0-10V Input. Note that the PID will not function with a bipolar analog input. It will ignore any negative voltages and treat them like a zero.
6 “4-20mA Input”	Selects the 4-20 mA Input.
7 “Preset Freq”	A410...A425 [Preset Freq x] will be used as an input for the PID Reference.
8 “Anlgn Multi” ⁽¹⁾	The product of the 0-10V and 4-20mA Inputs will be used as an input for the PID Reference.
9 “MOP Freq”	A427 [MOP Freq] will be used as an input for the PID Reference.
10 “Pulse Input”	Pulse train will be used as an input for the PID Reference.
11 “Step Logic” ⁽¹⁾	Step Logic will be used as an input for the PID Reference.
12 “Encoder” ⁽¹⁾	Encoder will be used as an input for the PID Reference.
13 “Ethernet/IP” ⁽¹⁾	The reference word from the Ethernet/IP communication network becomes the PID Reference.

(1) Setting is specific to PowerFlex 525 drives only.

[A460](#) and [A472](#) [PID x Fdbck Sel] are used to select the source of the PID feedback.

A460, A472 [PID x Fdbck Sel] Options

Options	Description
0 "0-10V Input"	Selects the 0-10V Input (default setting). Note that the PID will not function with a bipolar analog input. It will ignore any negative voltages and treat them like a zero.
1 "4-20mA Input"	Selects the 4-20 mA Input.
2 "Serial/DSI"	Serial/DSI will be used as an input for the PID Feedback.
3 "Network Opt"	The reference word from a communication network option becomes the PID Reference.
4 "Pulse Input"	Pulse train will be used as an input for the PID Feedback.
5 "Encoder" ⁽¹⁾	Encoder will be used as an input for the PID Feedback.
6 "Ethernet/IP" ⁽¹⁾	Ethernet/IP will be used as an input for the PID Feedback.

(1) Setting is specific to PowerFlex 525 drives only.

Analog PID Reference Signals

Parameters [r091](#) [Anlg In 0-10V Lo] and [r092](#) [Anlg In 0-10V Hi] are used to scale or invert an analog PID Reference or PID Feedback.

Scale Function

For a 0...5V signal, the following parameter settings are used so that a 0V signal = 0% PID Reference and a 5V signal = 100% PID Reference.

- [r091](#) [Anlg In 0-10V Lo] = 0.0%
- [r092](#) [Anlg In 0-10V Hi] = 50.0%
- [A459](#) [PID 1 Ref Sel] = 5 "0-10V Input"

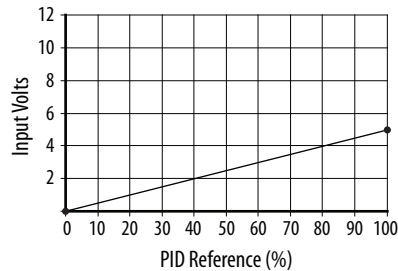

Invert Function

For a 4-20 mA signal, the following parameter settings are used so that a 20 mA signal = 0% PID Reference and a 4 mA signal = 100% PID Reference.

- [r092](#) [Anlg In4-20mA Lo] = 100.0%
- [r096](#) [Anlg In4-20mA Hi] = 0.0%

- A459 [PID 1 Ref Sel] = 6 “4-20mA Input”

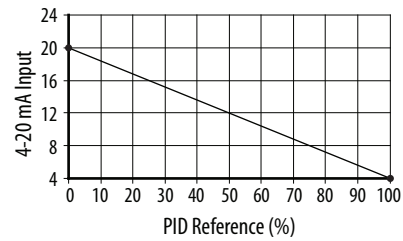

PID Deadband

Parameters [A465](#) and [A477](#) [PID x Deadband] are used to set a range, in percent, of the PID Reference that the drive will ignore.

Example

- A465 [PID 1 Deadband] = 5.0%
- The PID Reference is 25.0%
- The PID Regulator will not act on a PID Error that falls between 20.0 and 30.0%

PID Preload

The value set in [A466](#) or [A478](#) [PID x Preload], in Hz, will be pre-loaded into the integral component of the PID at any start or enable. This will cause the drive's frequency command to initially jump to that preload frequency, and the PID loop starts regulating from there.

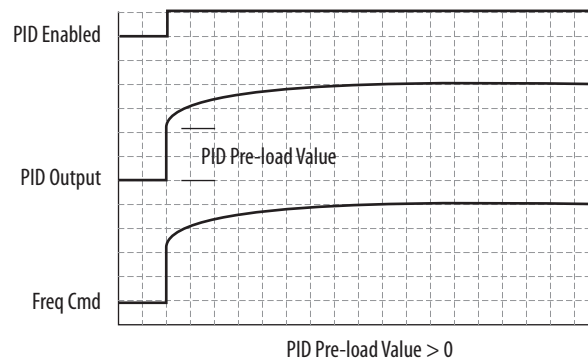

PID Limits

[A456](#) and [A468](#) [PID x Trim Hi] and [A457](#) and [A469](#) [PID x Trim Lo] are used to limit the PID output and are only used in trim mode. [PID x Trim Hi] sets the maximum frequency for the PID output in trim mode. [PID x Trim Lo] sets the reverse frequency limit for the PID output in trim mode. Note that when the

PID reaches the Hi or Lo limit, the PID regulator stops integrating so that windup does not occur.

PID Gains

The proportional, integral, and differential gains make up the PID regulator.

- [A461](#) and [A473](#) [PID x Prop Gain]
The proportional gain (unitless) affects how the regulator reacts to the magnitude of the error. The proportional component of the PID regulator outputs a speed command proportional to the PID error. For example, a proportional gain of 1 would output 100% of max frequency when the PID error is 100% of the analog input range. A larger value for [PID x Prop Gain] makes the proportional component more responsive, and a smaller value makes it less responsive. Setting [PID x Prop Gain] to 0.00 disables the proportional component of the PID loop.
- [A462](#) and [A474](#) [PID x Integ Time]
The integral gain (units of seconds) affects how the regulator reacts to error over time and is used to get rid of steady state error. For example, with an integral gain of 2 seconds, the output of the integral gain component would integrate up to 100% of max frequency when the PID error is 100% for 2 seconds. A larger value for [PID x Integ Time] makes the integral component less responsive, and a smaller value makes it more responsive. Setting [PID x Integ Time] to 0.0 disables the integral component of the PID loop.
- [A463](#) and [A475](#) [PID x Diff Rate]
The Differential gain (units of 1/seconds) affects the rate of change of the PID output. The differential gain is multiplied by the difference between the previous error and current error. Thus, with a large error the D has a large effect and with a small error the D has less of an effect. This parameter is scaled so that when it is set to 1.00, the process response is 0.1% of [P044](#) [Maximum Freq] when the process error is changing at 1% / second. A larger value for [PID x Diff Rate] makes the differential term have more of an effect and a small value makes it have less of an effect. In many applications, the D gain is not needed. Setting [PID x Diff Rate] to 0.00 (factory default) disables the differential component of the PID loop.

Guidelines for Adjusting the PID Gains

1. Adjust the proportional gain. During this step it may be desirable to disable the integral gain and differential gain by setting them to 0. After a step change in the PID Feedback:
 - If the response is too slow increase [A461](#) or [A473](#) [PID x Prop Gain].
 - If the response is too quick and/or unstable (see [Unstable Response on page 221](#)), decrease [A461](#) or [A473](#) [PID x Prop Gain].
 - Typically, [A461](#) or [A473](#) [PID x Prop Gain] is set to some value below the point where the PID begins to go unstable.

2. Adjust the integral gain (leave the proportional gain set as in Step 1). After a step change in the PID Feedback:
 - If the response is too slow (see [Slow Response – Over Damped on page 221](#)), or the PID Feedback does not become equal to the PID Reference, decrease A462 or A474 [PID x Integ Time].
 - If there is a lot of oscillation in the PID Feedback before settling out (see [Oscillation – Under Damped on page 221](#)), increase A462 or A474 [PID x Integ Time].
3. At this point, the differential gain may not be needed. However, if after determining the values for A461 or A473 [PID x Prop Gain] and A462 or A474 [PID x Integ Time]:
 - Response is still slow after a step change, increase A463 or A475 [PID x Diff Rate].
 - Response is still unstable, decrease A463 or A475 [PID x Diff Rate].

The following figures show some typical responses of the PID loop at different points during adjustment of the PID Gains.

Unstable Response

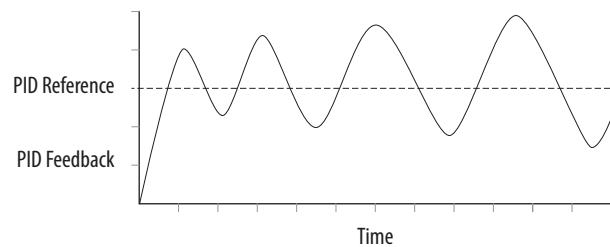

Slow Response – Over Damped

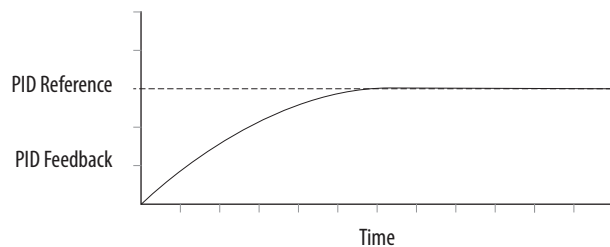

Oscillation – Under Damped

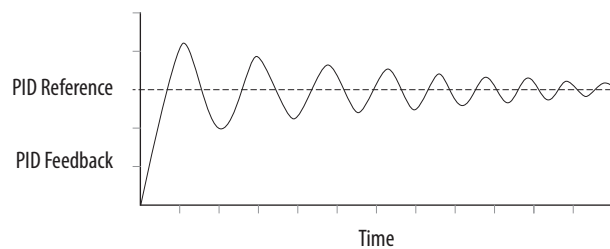

Good Response – Critically Damped

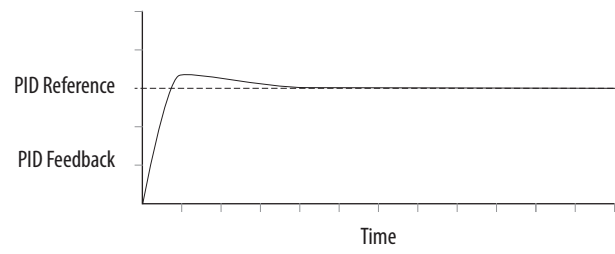

Safe-Torque-Off Function

The PowerFlex 525 Safe-Torque-Off function, when used with other safety components, helps provide protection according to EN ISO 13849 and EN62061 for safe-off and protection against restart. The PowerFlex 525 Safe-Torque-Off function is just one component in a safety control system. Components in the system must be chosen and applied appropriately to achieve the desired level of operator safeguarding.

For information on...	See page...
PowerFlex 525 Safe-Torque-Off Overview	223
EC Type Examination Certification	224
EMC Instructions	224
Using PowerFlex 525 Safe-Torque-Off	224
Enabling PowerFlex 525 Safe-Torque-Off	227
Wiring	227
Verify Operation	228
PowerFlex 525 Safe-Torque-Off Operation	227
Connection Examples	229
PowerFlex 525 Certification for Safe-Torque-Off	233

IMPORTANT The Safe-Torque-Off function covered in this chapter is specific to PowerFlex 525 drives only.

PowerFlex 525 Safe-Torque-Off Overview

The PowerFlex 525 Safe-Torque-Off function:

- Provides the Safe-Torque-Off (STO) function defined in EN IEC 61800-5-2.
- Blocks gate-firing signals from reaching the Insulated Gate Bipolar Transistor (IGBT) output devices of the drive. This prevents the IGBTs from switching in the sequence necessary to generate torque in the motor.
- Can be used in combination with other safety devices to fulfill the requirements of a system “safe torque off” function which satisfies Category 3 / PL (d) according to EN ISO 13849-1 and SIL CL2 according to EN/IEC 62061, IEC 61508, and EN/IEC 61800-5-2.

IMPORTANT The function is suitable for performing mechanical work on the drive system or affected area of a machine only. It does not provide electrical safety.



ATTENTION: Electric Shock Hazard. Verify that all sources of AC and DC power are de-energized and locked out or tagged out in accordance with the requirements of ANSI/NFPA 70E, Part II.

To avoid an electric shock hazard, verify that the voltage on the bus capacitors has discharged before performing any work on the drive. Measure the DC bus voltage at the +DC and -DC terminals or test points (refer to your drive's User Manual for locations). The voltage must be zero.

In safe-off mode, hazardous voltages may still be present at the motor. To avoid an electric shock hazard, disconnect power to the motor and verify that the voltage is zero before performing any work on the motor.

EC Type Examination Certification

TÜV Rheinland has certified the PowerFlex 525 Safe-Torque-Off function compliant with the requirements for machines defined in Annex I of the EC Directive 2006/42/EC, and that it complies with the requirements of the relevant standards listed below:

- EN ISO 13849-1:2008 Safety of machinery – Safety related parts of control systems – Part 1: General principles for design. (PowerFlex 525 STO achieves Category 3 / PL(d))
- EN 61800-5-2:2007 Adjustable speed electrical power drive systems – Part 5-2 Safety requirements – Functional. (PowerFlex 525 STO achieves SIL CL 2)
- EN 62061:2005 Safety of machinery – Functional safety of safety-related electrical, electronic and programmable electronic control systems.
- IEC 61508 Part 1-7:2010 Functional safety of electrical/electronic/programmable electronic safety-related systems – Parts 1-7.

TÜV also certifies that the PowerFlex 525 STO may be used in applications up to Category 3/ PL(d) according to EN ISO 13849-1 and SIL 2 according to EN 62061 / EN 61800-5-2 / IEC 61508.

The TÜV Rheinland certificate may be found at:
www.rockwellautomation.com/products/certification/.

EMC Instructions

PowerFlex 525 Safe-Torque-Off function requires CE Conformity as described on [page 49](#).

Using PowerFlex 525 Safe-Torque-Off

The PowerFlex 525 Safe-Torque-Off function is intended to be part of the safety related control system of a machine. Before use, a risk assessment should be performed that compares the PowerFlex 525 Safe-Torque-Off function specifications and all foreseeable operational and environmental characteristics of the machine to which it is to be fitted.

A safety analysis of the machine section controlled by the drive is required to determine how often the safety function should be tested for proper operation during the life of the machine.



ATTENTION: The following information is merely a guide for proper installation. Rockwell Automation cannot assume responsibility for the compliance or the noncompliance to any code, national, local or otherwise for the proper installation of this equipment. A hazard of personal injury and/or equipment damage exists if codes are ignored during installation.

ATTENTION: In safe-off mode, hazardous voltages may still be present at the motor. To avoid an electric shock hazard, disconnect power to the motor and verify that the voltage is zero before performing any work on the motor.

ATTENTION: In the event of the failure of two output IGBTs in the drive, when the PowerFlex 525 Safe-Torque-Off has controlled the drive outputs to the off state, the drive may provide energy for up to 180° of rotation in a 2-pole motor before torque production in the motor ceases.

Safety Concept

The PowerFlex 525 Safe-Torque-Off function is suitable for use in safety applications up to and including Category 3 / PL(d) according to EN ISO 13849-1 and SIL 2 according to EN 62061 / EN 61800-5-2 / IEC 61508.

In addition, the PowerFlex 525 STO may be used together with other components in a safety application to achieve an overall Category 3 / PL(e) according to EN ISO 13849-1 and SIL 3 according to EN 62061 and IEC 61508. This is illustrated in Example 3 in this appendix.

Safety requirements are based on the standards current at the time of certification.

The PowerFlex 525 Safe-Torque-Off function is intended for use in safety-related applications where the de-energized state is considered to be the safe state. All of the examples in this manual are based on achieving de-energization as the safe state for typical Machine Safety and Emergency Shutdown (ESD) systems.

Important Safety Considerations

The system user is responsible for:

- the set-up, safety rating, and validation of any sensors or actuators connected to the system.
- completing a system-level risk assessment and reassessing the system any time a change is made.
- certification of the system to the desired safety performance level.
- project management and proof testing.
- programming the application software and the safety option configurations in accordance with the information in this manual.

- access control to the system, including password handling.
- analyzing all configuration settings and choosing the proper setting to achieve the required safety rating.

IMPORTANT When applying Functional Safety, restrict access to qualified, authorized personnel who are trained and experienced.



ATTENTION: When designing your system, consider how personnel will exit the machine if the door locks while they are in the machine. Additional safeguarding devices may be required for your specific application.

Functional Proof Test

The PFD and PFH values provided in the table below are contingent upon the Proof Test Interval (PTI). Before the end of the PTI specified in the table below, a proof test of the STO safety function must be performed in order for the specified PFD and PFH values to remain valid.

PFD and PFH Data

PFD and PFH calculations are based on the equations from Part 6 of EN 61508.

This table provides data for a 20-year proof test interval and demonstrates the worst-case effect of various configuration changes on the data.

PFD and PFH for 20-year Proof Test Interval

Attribute	Value
PFD	6.62E-05 (MTTF = 3593 years)
PFH _D	8.13E-10
SFF	83%
DC	62.5%
CAT	3
HFT	1 (1002)
PTI	20 YEARS
Hardware Type	Type A

Safety Reaction Time

The safety reaction time is the amount of time from a safety-related event as input to the system until the system is in the Safe State.

The safety reaction time from an input signal condition that triggers a safe stop, to the initiation of safe-torque-off, is 100 ms (maximum).

Enabling PowerFlex 525 Safe-Torque-Off

1. Remove all power to the drive.



ATTENTION: To avoid an electric shock hazard, verify that the voltage on the bus capacitors has discharged before performing any work on the drive. Measure the DC bus voltage at the +DC and -DC terminals or test points (refer to your drive's user manual for the location of the terminals). The voltage must be zero.

2. Loosen the screw of terminals Safety 1, Safety 2 and Safety +24V (S1, S2, S+) on the control I/O terminal block.
3. Remove the protective jumper.

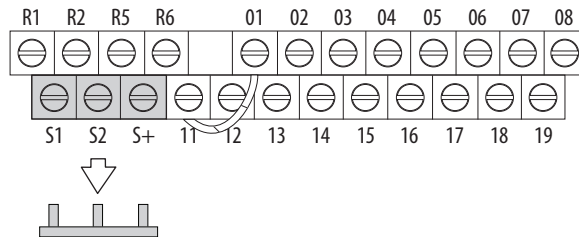

4. Safe-Torque-Off function is now enabled and the terminals are ready to function as safety inputs.

Wiring

Important points to remember about wiring:

- Always use copper wire.
- Wire with an insulation rating of 600V or greater is recommended.
- Control wires should be separated from power wires by at least 0.3 m (1 ft).

Recommended Wire

Type	Wire Type ⁽¹⁾	Description	Min. Insulation Rating
Shielded	Multi-conductor shielded cable such as Belden 8770 (or equiv.)	0.750 mm ² (18 AWG), 3 conductor, shielded.	300V, 60 °C (140 °F)

(1) Recommendations are for 50 °C ambient temperature.
75 °C wire must be used for 60 °C ambient temperature.
90 °C wire must be used for 70 °C ambient temperature.

See [I/O Wiring on page 35](#) for wiring recommendations and [Control I/O Terminal Designations on page 40](#) for terminal descriptions.

If Safety Inputs S1 and S2 are powered by an external +24V source, apply it only in SELV system, PELV system or low voltage Class 2 circuit.

PowerFlex 525 Safe-Torque-Off Operation

The PowerFlex 525 Safe-Torque-Off function disables the drive's output IGBT's by breaking the link with the drive microcontroller. When used in combination with a safety input device, the system satisfies the requirements of EN ISO 13849 and EN62061 for safe-torque-off and helps protect against restart.

Under normal drive operation, both safety inputs (Safety 1 and Safety 2) are energized, and the drive is able to run. If either input is de-energized, the gate control circuit becomes disabled. To meet EN ISO 13849 operation, both safety channels must be de-energized. Refer to the following examples for more information.

IMPORTANT By itself, the Safe-Torque-Off function initiates a coast to stop action. Additional protective measures will need to be applied when an application requires a change to the stop action.

Verify Operation

Test the safety function for proper operation after the initial setup of the PowerFlex 525 Safe-Torque-Off function. Retest the safety function at the intervals determined by the safety analysis described on [page 224](#).

Verify that both safety channels are functioning according to the table below.

Channel Operation and Verification

Safety Function Status	Drive In Safe State	Drive In Safe State	Drive In Safe State	Drive Able To Run
Drive Status	Configured by t105 [Safety Open En]	Fault F111 (Safety Hardware)	Fault F111 (Safety Hardware)	Ready/Run
Safety Channel Operation				
Safety Input S1	No Power Applied	Power Applied	No Power Applied	Power Applied
Safety Input S2	No Power Applied	No Power Applied	Power Applied	Power Applied

IMPORTANT If an external fault is present on the wiring or circuitry controlling the Safety 1 or Safety 2 inputs for a period of time, the Safe-Torque-Off function may not detect this condition. When the external fault condition is removed the Safe-Torque-Off function will allow an enable condition. Fault in the external wiring shall either be detected by external logic, or excluded (wiring must be protected by cable ducting or armoring), according to EN ISO 13849-2.

Connection Examples

Example 1 – Safe-Torque-Off Connection with Coast-to-Stop Action, SIL 2/PL d

Stop Category 0 – Coast

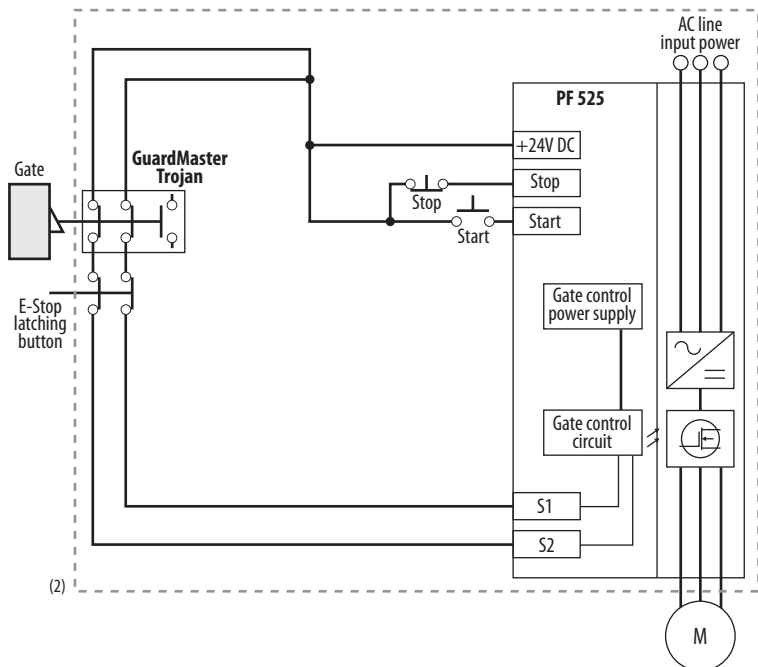
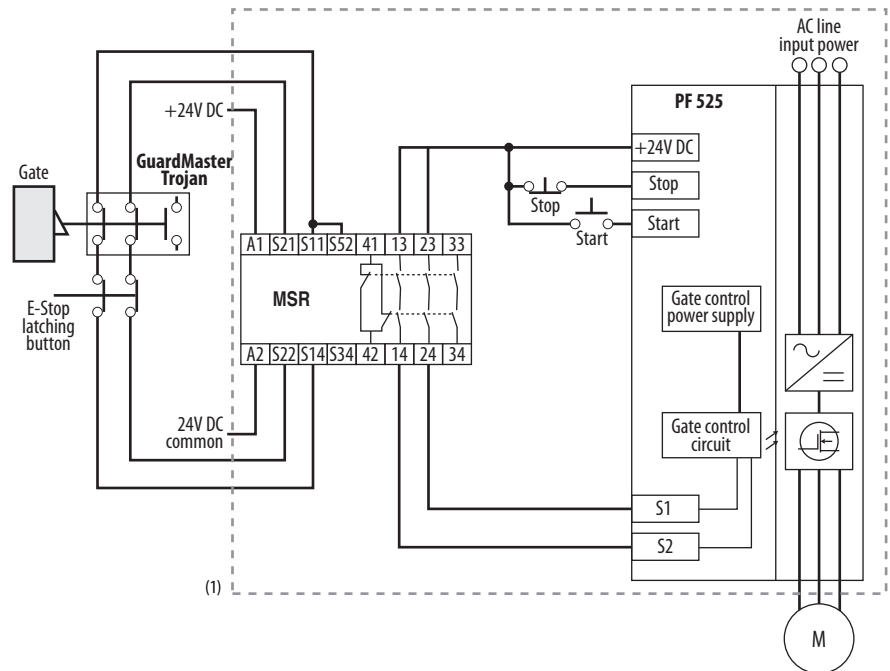

- (1) Enclosure Recommended. Note: External wiring failure modes must be considered as described in EN ISO 13849-2. Enclosure or other measure to exclude these failure modes should be used.
- (2) In some situations, a safety relay is not required if both the switch and PowerFlex 525 are installed in the same enclosure.

Stop Category 0 – Coast with Two PowerFlex 525 Drives

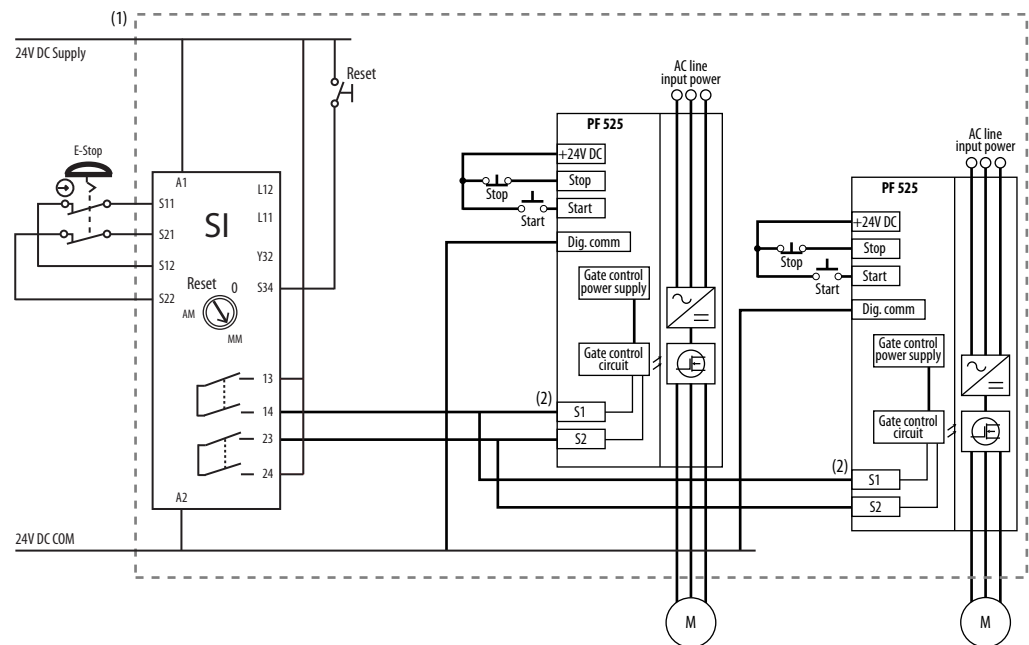

- (1) Enclosure Recommended. Note: External wiring failure modes must be considered as described in EN ISO 13849-2. Enclosure or other measure to exclude these failure modes should be used.
- (2) Each safety input draws 6 mA from the supply.

Circuit Status

Circuit shown with guard door closed and system ready for normal drive operation.

Operating Principle

This is a dual channel system with monitoring of the Safe-Torque-Off circuit and drive. Opening the guard door will switch the input circuits (S13-S14 & S21-S22) to the Minotaur monitoring safety relay unit. The output circuits (13-14 & 23-24) will cause the Safe-Torque-Off Enable circuit to trip and the motor will coast to stop. To restart the drive, the Minotaur safety relay must first be reset followed by a valid start command to the drive.

Fault Detection

A single fault detected on the Minotaur safety input circuits will result in the lock-out of the system at the next operation and will not cause loss of the safety function.

A single fault detected on the PowerFlex 525 safety enable redundant inputs will result in the lock-out of the drive and will not cause loss of the safety function.

Example 2 – Safe-Torque-Off Connection with Controlled Stop Action, SIL 2/PL d

Stop Category 1 – Controlled

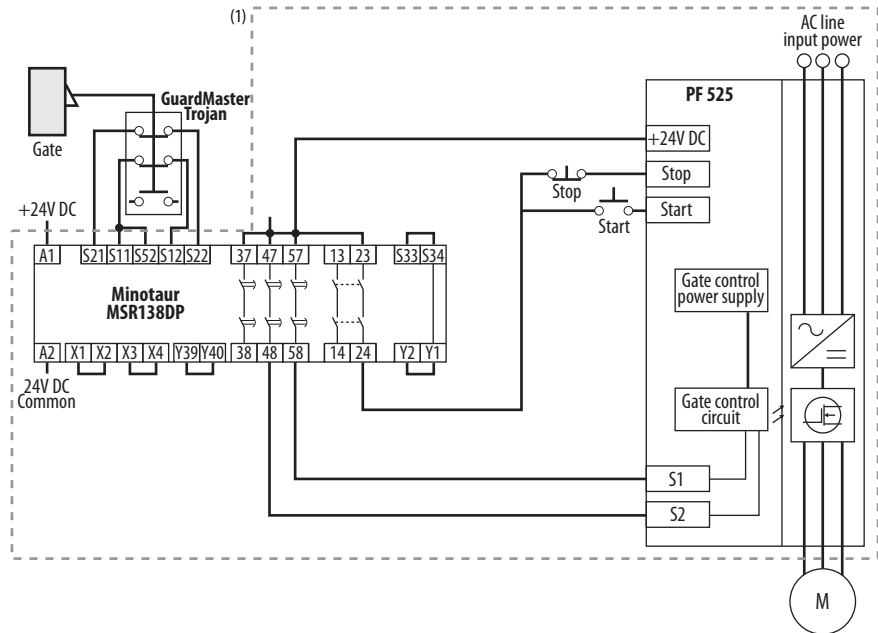

(1) Enclosure Recommended. External wiring failure modes must be considered as described in EN ISO 13849-2. Enclosure or other measure to exclude these failure modes should be used.

Circuit Status

Circuit shown with guard door closed and system ready for normal drive operation.

Operating Principle

This is a dual channel system with monitoring of the Safe-Torque-Off circuit and drive. Opening the guard door will switch the input circuits (S11-S12 & S21-S22) to the Minotaur monitoring safety relay unit. The output circuits (13-14) will issue a Stop command to the drive and cause a controlled deceleration. After the programmed delay, the timed output circuits (47-48 & 57-58) will cause the Safe-Torque-Off Enable circuit to trip. If the motor is rotating when the trip occurs, it will coast to stop. To restart the drive, the Minotaur safety relay must first be reset followed by a valid start command to the drive.

Fault Detection

A single fault detected on the Minotaur safety input circuits will result in the lock-out of the system at the next operation and will not cause loss of the safety function.

A single fault detected on the PowerFlex 525 safety enable redundant inputs will result in the lock-out of the drive and will not cause the loss of the safety function.

Example 3 – Safe-Torque-Off Connection with Coast-to-Stop Action Using External +24V supply, SIL 3/PL e

Stop Category 0 – Coast

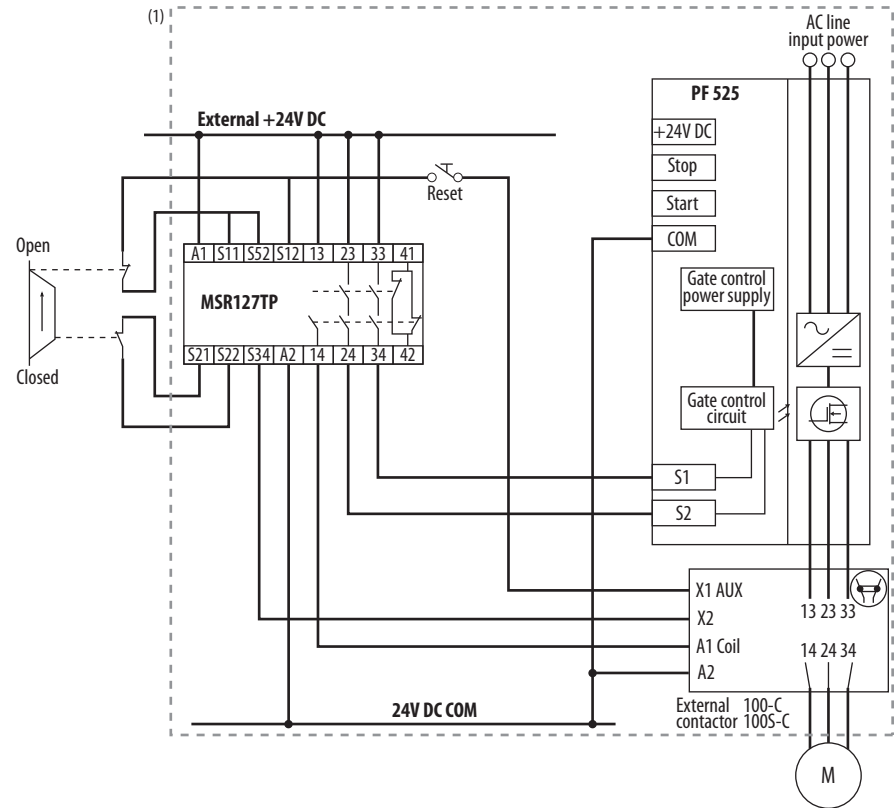

(1) Enclosure Recommended. External wiring failure modes must be considered as described in EN ISO 13849-2. Enclosure or other measure to exclude these failure modes should be used.

Circuit Status

Circuit shown with guard door closed and system ready for normal drive operation.

Operating Principle

This is a dual channel system with monitoring of the Safe-Torque-Off circuit and drive. Opening the guard door will switch the input circuits (S11-S12 & S21-S22) to the Minotaur monitoring safety relay unit. The output circuits (13-14 & 23-24 & 33-34) will cause the output contact and Safe-Torque-Off Enable circuit to trip and the motor will coast to stop. To restart the drive, the Minotaur safety relay must first be reset followed by a valid start command to the drive.

Fault Detection

A single fault detected on the Minotaur safety input circuits will result in the lock-out of the system at the next operation and will not cause loss of the safety function.

PowerFlex 525 Certification for Safe-Torque-Off



TÜVRheinland®

ZERTIFIKAT
CERTIFICATE

EC Type-Examination Certificate
Reg.-No.: 01/205/5249/12

Product tested	Safety Function "Safe Torque Off" (STO) within the adjustable Frequency AC Drive PowerFlex 525	Certificate holder	Rockwell Automation 6400 West Enterprise Drive Mequon, WI 53092 USA
Type designation	PowerFlex 525; 25B, 120V, 240V, 400-480V and 600V	Manufacturer	see certificate holder
Codes and standards forming the basis of testing	EN 61800-5-2:2007 EN 61800-5-1:2007 (in extracts) EN 61800-3:2004 EN 62061:2005		EN ISO 13849-1:2008 + AC:2009 EN 60204-1:2006 + A1:2009 (in extracts) IEC 61508 Parts 1-7:2010
Intended application	The integrated safety function "Safe Torque Off" of the Frequency AC Drive PowerFlex 525 complies with the requirements of the relevant standards (Cat. 3/ PL d acc. to EN ISO 13849-1, SILCL 2 acc. to EN 62061/ EN 61800-5-2/ IEC 61508) and can be used in applications up to Cat. 3/ PL d acc. to EN ISO 13849-1, SIL 2 acc. to EN 62061/ IEC 61508.		
Specific requirements	The instructions of the associated Installation and Operating Manual shall be considered.		
It is confirmed, that the product under test complies with the requirements for machines defined in Annex I of the EC Directive 2006/42/EC.			
This certificate is valid until 2017-09-24.			



Functional Safety Type Approved
FS

The test report-no.: 968/M 365.00/12 dated 2012-09-24 is an integral part of this certificate.

The holder of a valid licence certificate for the product tested is authorized to affix the test mark shown opposite to products, which are identical with the product tested.

Berlin, 2012-09-24



Certification Body for Machinery, NB 0035



Dipl.-Ing. Eberhard Frejno

TÜV Rheinland Industrie Service GmbH, Altonstr. 56, 12103 Berlin / Germany
Tel.: +49 30 7562-1557, Fax: +49 30 7562-1370, E-Mail: tuvs@de.tuv.com

Notes:

EtherNet/IP

This section contains only basic information to setup an EtherNet/IP connection with your PowerFlex 520-series drive. For comprehensive information about EtherNet/IP (single and dual-port) and how to use it, see the following publications:

- PowerFlex 525 Embedded EtherNet/IP Adapter User Manual, publication [520COM-UM001](#).
- PowerFlex 25-COMM-E2P Dual-Port EtherNet/IP Adapter User Manual, publication [520COM-UM003](#).



ATTENTION: PowerFlex 523 drives support only the 25-COMM-E2P dual-port EtherNet/IP adapter. PowerFlex 525 drives support both the embedded EtherNet/IP adapter and the 25-COMM-E2P dual-port EtherNet/IP adapter.

It is recommended to use Allen-Bradley Ethernet RJ45 cables, shielded or unshielded (catalog number 1585J-M8xBJM-x), for connecting your PowerFlex 520-series drive to an EtherNet/IP network.

Establishing A Connection With EtherNet/IP

There are three methods for configuring the Ethernet IP address:

- **BootP Server** – Use BootP if you prefer to control the IP addresses of devices using a server. The IP address, subnet mask, and gateway addresses will then be provided by the BootP server.
- **Adapter Parameters** – Use adapter parameters when you want more flexibility in setting up the IP address, or need to communicate outside the control network using a gateway. The IP address, subnet mask, and gateway addresses will then come from the adapter parameters you set.
- **DHCP (Dynamic Host Configuration Protocol)** (only with PowerFlex 25-COMM-E2P adapter) – Use DHCP when you want additional flexibility and ease-of-use compared to BOOTP in configuring the IP address, subnet mask, and gateway address for the adapter using a DHCP server.

IMPORTANT

If you are setting your network addresses manually using parameters, you must set the appropriate drive or 25-COMM-E2P adapter parameter value to 1 "Parameters". See the respective EtherNet/IP adapter user manual for more information.

IMPORTANT Regardless of the method used to set the adapter IP address, each node on the EtherNet/IP network must have a unique IP address. To change an IP address, you must set the new value and then remove and reapply power to (or reset) the adapter.

Control Diagrams

This chapter contains various diagrams on the PowerFlex 520-series drive functions and behaviors.

Induction Motor Tuning Diagrams

[Speed Reg Sel] Diagrams For Motor Tuning

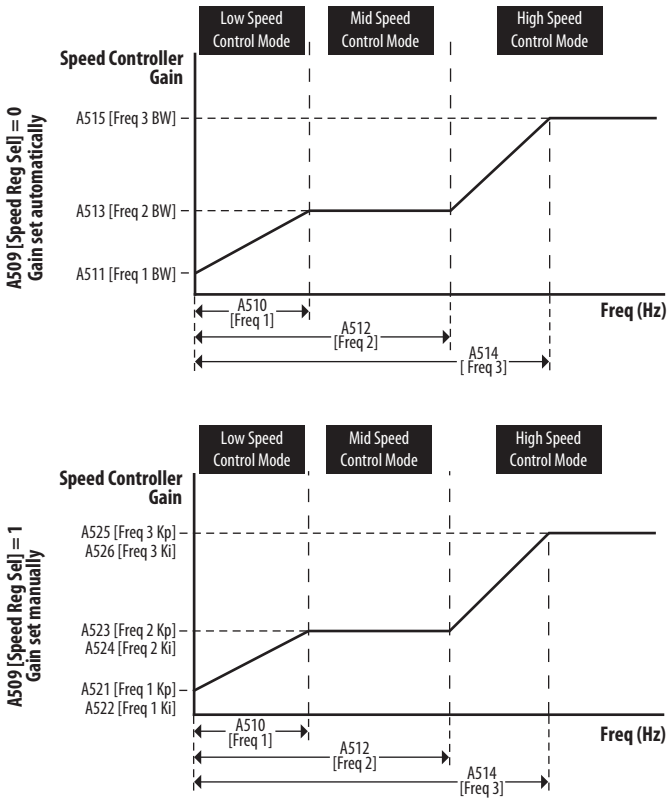

Adjusting Speed Control Parameters

These settings show how to adjust the speed control for motor tuning.

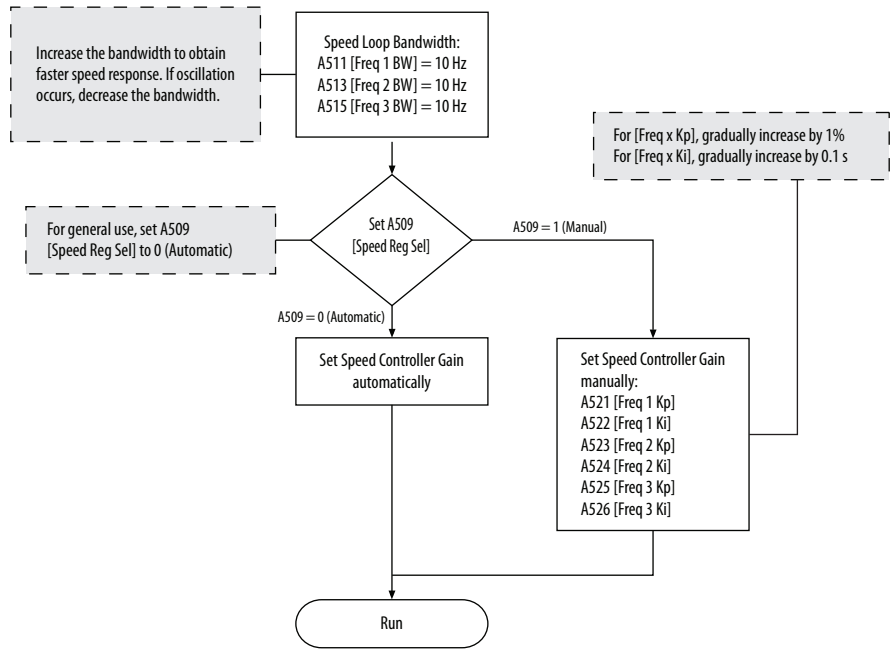

Numerics

- 2-wire
 - inputs, **47**
- 3-wire
 - inputs, **47**

A

- accel
 - override priority, **48**
 - selecting, **48**
- accessing
 - control terminals, **30**
 - power terminals, **30**
- applications
 - safety, **225**
- auxiliary contact
 - drive, **33, 35**

B

- basic operation, **61**
 - drive, **56, 61, 150**
 - programming, **61**
 - safety, **228**

C

- circuit breakers
 - inputs, **22**
 - ratings, **22**
- common bus
 - drive, **35**
- communications
 - positioning, **212**
- configuring
 - RS485(DSI), **190**
- control terminals
 - accessing, **30**
- counter
 - programming, **197, 200**

D

- decel
 - override priority, **48**
 - selecting, **48**
- derating
 - factor, **117**
 - temperature, **17**
- digital inputs
 - selecting, **47**
 - start source, **47**
- dimensions
 - mounting, **16, 173**
- disconnect
 - output, **33**
- drive
 - auxiliary contact, **33, 35**

- basic operation, **56, 61, 150**
- common bus, **35**
- mount, **15**
- programming, **57, 60**
- safety, **227**
- drive damage
 - preventing, **19**
 - ungrounded distribution systems, **19**

E

- encoder
 - programming, **203**
 - wiring, **204**
- environment
 - storage, **18**
- Ethernet
 - programming, **235**

F

- fault monitoring
 - ground, **21**
- fuses
 - rating, **22**

G

- ground
 - fault monitoring, **21**
 - motor, **21**
 - RFI filter, **21**
 - safety, **21**
 - shielding, **21**

H

- homing
 - automatic, **210**
 - manual, **210**
 - programming, **210**

I

- inputs
 - 2-wire, **47**
 - 3-wire, **47**
 - circuit breakers, **22**
 - power, **20**

L

- logic
 - basic, **197, 198**
 - timed steps, **197, 198**

M

- Modbus
 - reading, **193, 195, 196**

writing, **191, 193, 196**
motor
 ground, **21**
 start, **33**
 stop, **33**
mount
 drive, **15**
mounting
 dimensions, **16, 173**

N

noise immunity
 wiring, **36, 190**

O

output
 disconnect, **33**
override priority
 accel, **48**
 decel, **48**
 speed reference, **46**
 start source, **46**

P

parameters
 AppView, **68, 138**
 CustomView, **139**
 programming, **59, 63**
PID
 programming, **217**
positioning
 communications, **212**
 programming, **205, 206**
power
 inputs, **20**
power and control module
 separating, **27**
power terminals
 accessing, **30**
preventing
 drive damage, **19**
programming, **61**
 basic logic, **197, 198**
 counter, **197, 200**
 drive, **57, 60**
 encoder, **203**
 Ethernet, **235**
 homing, **210**
 parameters, **59, 63**
 PID, **217**
 positioning, **205, 206**
 pulse train, **203**
 timed steps, **197, 198**
 timer, **197, 199**
 tools, **60**
pulse train
 programming, **203**

R

rating
 fuses, **22**
ratings
 circuit breakers, **22**
reading
 Modbus, **193, 195, 196**
recommended
 wiring, **35, 227**
reflected
 wave protection, **33**
RFI filter
 ground, **21**
RS485(DSI)
 configuring, **190**

S

safety
 applications, **225**
 basic operation, **228**
 drive, **227**
 ground, **21**
 testing, **226**
 wiring, **227**
selecting
 accel, **48**
 decel, **48**
 digital inputs, **47**
 speed reference, **46**
 start source, **46**
separating
 power and control module, **27**
shielded
 wiring, **32**
shielding
 ground, **21**
speed reference
 override priority, **46**
 selecting, **46**
start
 motor, **33**
start source
 digital inputs, **47**
 override priority, **46**
 selecting, **46**
stop
 motor, **33**
storage
 environment, **18**

T

temperature
 derating, **17**
 wiring, **32**
testing
 safety, **226**
timer

programming, **197, 199**
tools
programming, **60**

U

unshielded
wiring, **32**

V

voltage reflections
wiring, **33**

W

wave protection
reflected, **33**
wiring
encoder, **204**
noise immunity, **36, 190**
recommended, **35, 227**
RS485 (DSI), **189**
safety, **227**
shielded, **32**
temperature, **32**
unshielded, **32**
voltage reflections, **33**
writing
Modbus, **191, 193, 196**

Notes:

Rockwell Automation Support

Rockwell Automation provides technical information on the Web to assist you in using its products.

At <http://www.rockwellautomation.com/support/>, you can find technical manuals, a knowledge base of FAQs, technical and application notes, sample code and links to software service packs, and a MySupport feature that you can customize to make the best use of these tools.

For an additional level of technical phone support for installation, configuration, and troubleshooting, we offer TechConnect support programs. For more information, contact your local distributor or Rockwell Automation representative, or visit <http://www.rockwellautomation.com/support/>.

Installation Assistance

If you experience a problem within the first 24 hours of installation, review the information that is contained in this manual. You can contact Customer Support for initial help in getting your product up and running.

United States or Canada	1.440.646.3434
Outside United States or Canada	Use the Worldwide Locator at http://www.rockwellautomation.com/support/americas/phone_en.html , or contact your local Rockwell Automation representative.

New Product Satisfaction Return

Rockwell Automation tests all of its products to ensure that they are fully operational when shipped from the manufacturing facility. However, if your product is not functioning and needs to be returned, follow these procedures.

United States	Contact your distributor. You must provide a Customer Support case number (call the phone number above to obtain one) to your distributor to complete the return process.
Outside United States	Please contact your local Rockwell Automation representative for the return procedure.

Documentation Feedback

Your comments will help us serve your documentation needs better. If you have any suggestions on how to improve this document, complete this form, publication [RA-DU002](#), available at <http://www.rockwellautomation.com/literature/>.

www.rockwellautomation.com

Power, Control and Information Solutions Headquarters

Americas: Rockwell Automation, 1201 South Second Street, Milwaukee, WI 53204-2496 USA, Tel: (1) 414.382.2000, Fax: (1) 414.382.4444

Europe/Middle East/Africa: Rockwell Automation NV, Pegasus Park, De Kleetlaan 12a, 1831 Diegem, Belgium, Tel: (32) 2 663 0600, Fax: (32) 2 663 0640

Asia Pacific: Rockwell Automation, Level 14, Core F, Cyberport 3, 100 Cyberport Road, Hong Kong, Tel: (852) 2887 4788, Fax: (852) 2508 1846